

SUMMARY



Image is for illustrative purpose only

Wires

Low voltage 16

Series	2K
Termination type	Female solder
IP rating	68
AWG wire size	30.00 - 22.00
Cable Ø	0.00 - 0.00 mm
Status	active
Matching parts	FGG.2K.316.CLAC50Z

Download

[Request a quote](#)

[Catalog](#)

TECHNICAL DETAILS

Mechanics

Shell Style/Model	EE*: Fixed receptacle, nut fixing (back panel mounting)
Keying	1 key (alpha=0, plug: male contacts, receptacle: female contacts)
Housing Material	Brass (chrome plated [SAE AMS 2460]) shell and collet nut, nickel plated [SAE AMS QQ N 290] brass latch sleeve and mid pieces
Weight	34.78 g

Performance

Configuration	2K.316 : 16 Low Voltage
Insulator	L: PEEK (UL 94 / V-0/1.5)
Rated Current	6 Amps

Specifications

Contact Type:	Solder
Contact Dia.:	0.7 mm (0.028in)
Bucket Dia.:	0.8 mm (0.031in)
Max. Solid Conductor:	0.34 mm ² (AWG 22)
Max. Stranded Conductor:	0.34 mm ² (AWG 22)
R (max):	6.1 mOhm
Vtest (contact-shell):	1250 V (AC), 1770 V (DC)
Vtest (contact-contact):	950 V (AC), 1340 V (DC)

LEMO products and services are provided "as is". LEMO makes no warranties or representations with regard to LEMO product & services or use of them, express, implied or statutory, including for accuracy, completeness, or security. The user is fully responsible for his products and applications using LEMO components.

Others

Endurance (Shell): 5000 mating cycles
 Temp (min / max): -55°C / +200°C
 Humidity (max): <=95% [at 60 deg C / 140 F]
 Vibration: 15 g [10 Hz - 2000 Hz]
 Shock Resistance: 100 g [6 ms]
 Climatical Category: 50/175/21
 Shielding (min): 95 dB (10 MHz)
 Shielding (min): 80 dB (1 GHz)
 Salt Spray Corrosion: >1000 hr

DRAWINGS

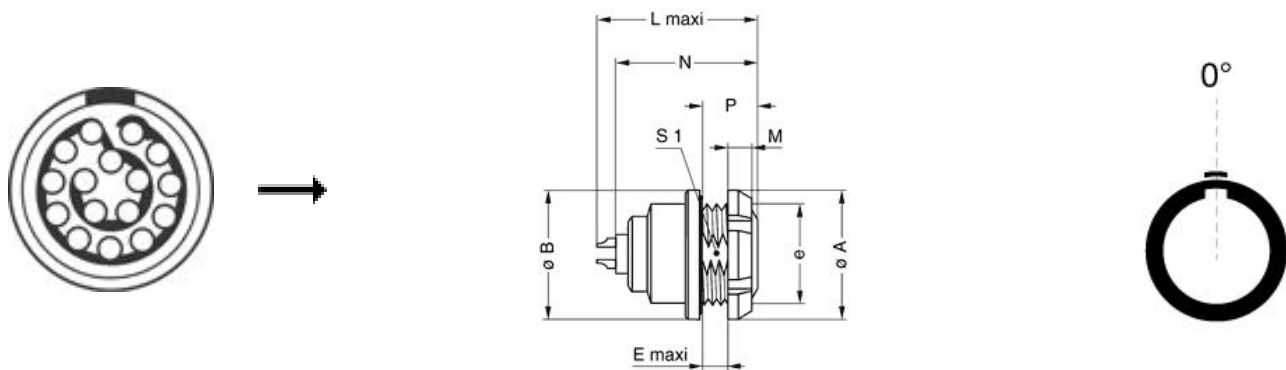

Dimensions











	A	B	E	L	M	N	P	S1	e
mm.	25	25	5	30.7	3.5	28.6	10	18.5	M20x1.0
in.	0,98	0,98	0,20	1,21	0,14	1,13	0,39	0,73	

RECOMMENDED BY LEMO

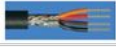
Tools

LEMO products and services are provided "as is". LEMO makes no warranties or representations with regard to LEMO product & services or use of them, express, implied or statutory, including for accuracy, completeness, or security. The user is fully responsible for his products and applications using LEMO components.

Cables

CMN.16.T22.076QGZE	TPR (medical)	Grey	
CMN.16.T28.059PGZE		Grey	
CMN.16.T28.059PNZE			
CMN.16.T28.070NNZZ			
CMN.16.T30.047QGZE	TPR (medical)	Grey	
116080	PUR	Black	
116280	PVC	Black	
16050	PVC	Black	
216220	PVC	Black	
216240	PVC	Black	
216260	PVC	Black	
316250	PVC	Grey	

LEMO products and services are provided "as is". LEMO makes no warranties or representations with regard to LEMO product & services or use of them, express, implied or statutory, including for accuracy, completeness, or security. The user is fully responsible for his products and applications using LEMO components.

X-ON Electronics

Largest Supplier of Electrical and Electronic Components

Click to view similar products for [Circular Push Pull Connectors](#) category:

Click to view products by [LEMO](#) manufacturer:

Other Similar products are found below :

[6407-249V-11273P](#) [6408-201V-13273](#) [6408-202V-13343](#) [6408-202V-17343](#) [EZG.0B.309.CLN](#) [FFA.2S.310.ZLA](#) [FGA.1B.307.CYCD72Z](#)
[FGJ.1B.304.CLLD76](#) [FGJ.1B.306.CWLD72](#) [FGJ.3B.304.CYMD10Z](#) [FGJ.3B.304.CYMD82Z](#) [FHG.1B.303.CYCZ](#) [PCS.01.250.DLLE24](#)
[PHG.0K.305.CYMC40Z](#) [PHG.1K.308.CLLK85](#) [PKG.M0.6BL.LZ](#) [PLC.M1.0SL.LA](#) [GMA.10.290.DN](#) [GMA.3B.090.DA](#)
[PRG.M0.6GL.LC52GZ](#) [PSA.1S.275.CTLC66](#) [ABF.1S.250.NTA](#) [133020F](#) [1331ER193MZ](#) [1332M107MZ](#) [DTS26Z19-32JA-LC](#) [DTS26Z19-](#)
[32SA](#) [DTS26Z19-32SA-LC](#) [EAJ.1B.306.CWA](#) [ECG.XB.312.CLL](#) [1589430-2](#) [EEA.0B.305.CLN](#) [EEA.0B.309.CLL](#) [ELF.00.250.NTL](#)
[ERA.01.250.DLL](#) [BRR.2S.200.PZVG](#) [HR10A-P](#) [CAH.M34.SLL.C72GZ](#) [CAJ.M34.SLL.C72GZ](#) [300500](#) [ESB.00.303.NLL](#)
[EXG.0B.309.HLN](#) [FFB.1S.250.CLAC27](#) [FGA.2B.306.CYCD92](#) [FGA.2B.306.CYCD92Z](#) [FGJ.1B.302.CYMD62](#) [FGJ.3B.308.CLLD72Z](#)
[FHG.1B.303.CYCD62](#) [FLC.00.250.CTAC31](#) [PCS.01.250.DLLE31](#)