

SUMMARY



Image is for illustrative purpose only

Wires

Low voltage 16

Series 3E
Termination type Female solder
IP rating 68
AWG wire size 30.00 - 22.00
Cable Ø 0.00 - 0.00 mm
Status active

Download

[Request a quote](#)
[Catalog](#)

TECHNICAL DETAILS

Mechanics

Shell Style/Model EEP*: Fixed receptacle, nut fixing (back panel mounting)
Keying Hermaphroditic keying (half moon insert) with female pin 1
Housing Material Brass (chrome plated [SAE AMS 2460]) shell and collet nut, nickel plated [SAE AMS QQ N 290] brass latch sleeve and mid pieces
Weight 59.30 g

Performance

Configuration 3E.316 : 16 Low Voltage
Insulator L: PEEK (UL 94 / V-0/1.5)
Rated Current 7 Amps

Specifications

Contact Type: Solder
Contact Dia.: 0.9 mm (0.0354in)
Bucket Dia.: 0.8 mm (0.031in)
Max. Solid Conductor: 0.34 mm² (AWG 22)
R (max): 4.8 mOhm
Vtest: 1060 V (AC), 1500 V (DC)

Others

LEMO products and services are provided "as is". LEMO makes no warranties or representations with regard to LEMO product & services or use of them, express, implied or statutory, including for accuracy, completeness, or security. The user is fully responsible for his products and applications using LEMO components.

Endurance (Shell): 5000 mating cycles
 Temp (min / max): -55°C / +200°C
 Humidity (max): <=95% [at 60 deg C / 140 F]
 Vibration: 15 g [10 Hz - 2000 Hz]
 Shock Resistance: 100 g [6 ms]
 Climatical Category: 50/175/21
 Shielding (min): 95 dB (10 MHz)
 Shielding (min): 80 dB (1 GHz)
 Salt Spray Corrosion: >1000 hr

DRAWINGS

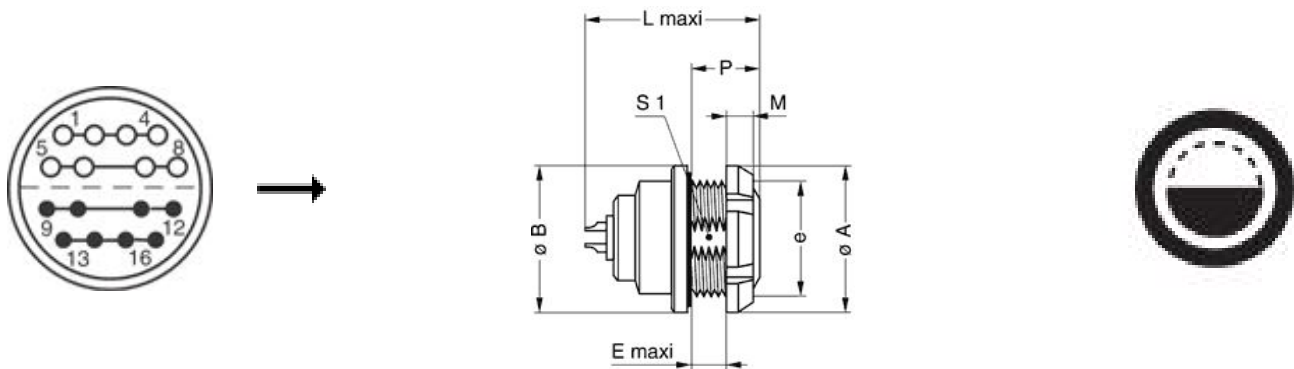

Dimensions











	A	B	E	L	M	P	S1	e
mm.	30	31	7.5	34	4.5	12	22.5	M24x1.0
in.	1,18	1,22	0,30	1,34	0,18	0,47	0,89	

RECOMMENDED BY LEMO

Tools

Cables

LEMO products and services are provided "as is". LEMO makes no warranties or representations with regard to LEMO product & services or use of them, express, implied or statutory, including for accuracy, completeness, or security. The user is fully responsible for his products and applications using LEMO components.

CMN.16.T22.076QGZE	TPR (medical)	Grey	
CMN.16.T28.059PGZE		Grey	
CMN.16.T28.059PNZE			
CMN.16.T28.070NNZZ			
CMN.16.T30.047QGZE	TPR (medical)	Grey	
116080	PUR	Black	
116280	PVC	Black	
16050	PVC	Black	
216220	PVC	Black	
216240	PVC	Black	
216260	PVC	Black	
316250	PVC	Grey	

LEMO products and services are provided "as is". LEMO makes no warranties or representations with regard to LEMO product & services or use of them, express, implied or statutory, including for accuracy, completeness, or security. The user is fully responsible for his products and applications using LEMO components.

X-ON Electronics

Largest Supplier of Electrical and Electronic Components

Click to view similar products for [Circular Push Pull Connectors](#) category:

Click to view products by [LEMO](#) manufacturer:

Other Similar products are found below :

[6407-249V-11273P](#) [6408-201V-13273](#) [6408-202V-13343](#) [6408-202V-17343](#) [EZG.0B.309.CLN](#) [FFA.2S.310.ZLA](#) [FGA.1B.307.CYCD72Z](#)
[FGJ.1B.304.CLLD76](#) [FGJ.1B.306.CWLD72](#) [FGJ.3B.304.CYMD10Z](#) [FGJ.3B.304.CYMD82Z](#) [PCS.01.250.DLLE24](#) [PHG.0K.305.CYMC40Z](#)
[PHG.1K.308.CLLK85](#) [PKG.M0.6BL.LZ](#) [PLC.M1.0SL.LA](#) [GMA.10.290.DN](#) [GMA.3B.090.DA](#) [PRG.M0.6GL.LC52GZ](#) [PSA.1S.275.CTLC66](#)
[ABF.1S.250.NTA](#) [133020F](#) [1331ER193MZ](#) [1332M107MZ](#) [DTS26Z19-32JA-LC](#) [DTS26Z19-32SA](#) [DTS26Z19-32SA-LC](#) [DTS26Z23-55HA](#)
[DTS26Z23-55HA-LC](#) [DTS26Z23-55JA-LC](#) [EAJ.1B.306.CWA](#) [ECG.XB.312.CLL](#) [1589430-2](#) [EEA.0B.305.CLN](#) [EEA.0B.309.CLL](#)
[ELF.00.250.NTL](#) [ERA.01.250.DLL](#) [BRR.2S.200.PZVG](#) [HR10A-P](#) [CAH.M34.SLL.C72GZ](#) [CAJ.M34.SLL.C72GZ](#) [300500](#) [ESB.00.303.NLL](#)
[EXG.0B.309.HLN](#) [FFB.1S.250.CLAC27](#) [FGA.2B.306.CYCD92](#) [FGA.2B.306.CYCD92Z](#) [FGA.XB.312.CLAD72](#) [FGJ.1B.302.CYMD62](#)
[FGJ.3B.308.CLLD72Z](#)