

M series Connectors ratchet coupling



Precision modular connectors to suit your application

Since its creation in Switzerland in 1946 the LEMO Group has been recognized as a global leader of circular Push-Pull connectors and interconnect solutions. Today LEMO and its affiliated companies, REDEL and COELVER, are active in more than 80 countries with the help of over 40 subsidiaries and distributors.

Over 90000 connectors

The modular design of the LEMO range provides over 90000 connectors from miniature \varnothing 3 mm to \varnothing 50 mm, capable of handling cable diameters up to 30 mm and for up to 114 contacts. This vast portfolio enables you to select the ideal connector configuration to suit almost any specific requirement in most markets, including medical devices, test and measurement instruments, machinery, audio video broadcast, telecommunications and military.

LEMO's ratchet 3/4 turn connection system

This highly robust 3/4 turn screw locking system is recognized worldwide for the most demanding applications as a safe, secure and quick screw mating system. Its special ratchet mechanisms provides ultra high reliability in the most severe vibrations environments, shocks or pull on the cables.

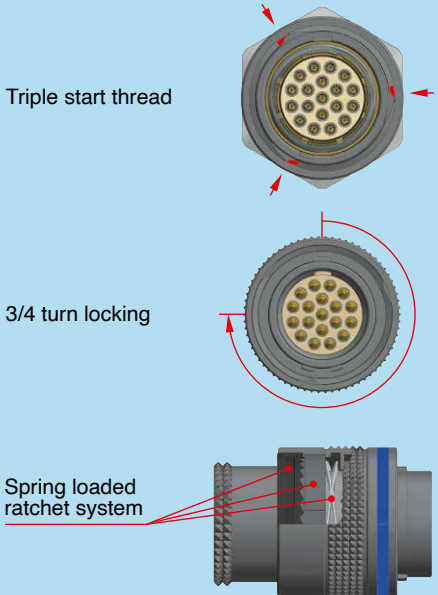

Triple start thread

- Very fast coupling nut engagement in the socket
- Stable thread engagement making tilted nut engagement impossible

3/4 turn locking

- Quick and fast connection requiring less than a full turn for complete mating
- Full mating possible with a single hand movement



Spring loaded ratchet on locking nut

- Secure mating in high vibration environments
- No specific mating torque required to secure
- No tools required; hand torquing force is sufficient to secure

UL Recognition

LEMO connectors are components recognized by the Underwriters Laboratories (UL), facilitating the UL approval of the complete system (including LEMO connector, cable and your equipment).

CE marking

CE marking  means that the appliance or equipment complies with the protection requirements of one or several European safety directives. CE marking  applies to complete products or equipment, **but not to electromechanical components, such as connectors.**

REACH and RoHS

LEMO connector specifications comply with the requirements of the RoHS directive (2011/65/EU) and REACH regulation (1907/2006/EU) of the European Parliament and latest amendments. These REACH and ROHS regulations specify the restrictions of the use of hazardous substances in LEMO products marketed in Europe.

Product safety notice & disclaimers

Please read and follow all instructions specified on the last page or on our [website](#) carefully and consult all relevant national and international safety regulations for your application. Improper handling, cable assembly, or wrong use of connectors can result in hazardous situations.

LEMO products and services are provided "as is." LEMO makes no warranties or representations with regard to LEMO product & services or use of them, express, implied or statutory, including for accuracy, completeness, or security.

In no event shall LEMO be liable for any direct, indirect, punitive, incidental, special consequential damages, to property or life, whatsoever arising out of or connected with the use or misuse of LEMO's products.

Introduction

This catalogue provides a complete description of the LEMO M series portfolio. M series connectors are lightweight triple-start ratchet coupling type connectors designed for avionics, aerospace, military, security, motorsport and heavy duty applications.

The M series is a COTS (Commercial Off-The-Shelf) product, that fulfills the harshest MIL-DTL-38999 requirements in a more compact and lightweight package. It features a very wide range of configurable options to fulfill every applications. The LEMO engagement for supplying innovative solutions which meets users highest expectations translates thought the M series in a highly reliable interconnect solution that helps our customers reduce their maintenance and downtime in critical applications.

The LEMO quality arises from years of expertise in design, manufacturing and quality system where all single M series connectors get identified with a laser engraved part number and production batch number for full traceability from raw materials to fully assembled product.

Table of contents

Technical characteristics	2
M Series	
Interconnections	4
Standard models part numbering system, Others part numbering system, Part section showing internal components	5
Locking nuts options, Backshell options	6
Standard models.....	7
Watertight model (unmated)	14
Vacuumtight model (unmated).....	15
High Speed models	16
USB 2.0 models.....	18
Fibre Optic models.....	19
High Power models.....	21
Alignment key and Polarized keying system	23
Insert configuration	
Multipole	24
Mixed multipole, Multipole high speed ethernet cat6.....	26
USB 2.0, Multi fibre and Mixed fibre optic + low voltage, Mixed high speed coax.....	27
High Power	28
Contacts	
Crimp, High speed ethernet cat6	30
Coaxial, High Voltage, High Power, F7 Fibre Optic.....	31
Accessories	32
Tooling	38
Panel cut-outs and PCB drilling pattern	41
Assembly instructions	46
Product safety notice	49



Technical characteristics

Materials and treatments

Component	Shell material code 1)				Material (Standard)	Surface treatment (µm)		
	X	C	L	I		chrome	nickel	gold
Outer shell, conical nut, coupling nut	● ²⁾				Aluminium alloy (AA 6262A or AA 6023)	–	5	–
		●			Brass (UNS C 38500)	0.3	–	–
			●		Aluminium alloy (AA 6262A or AA 6023)	anodized		
				● ²⁾	Aluminium alloy (AA 6262A or AA 6023)	–	14	–
Earthing crown		●			Bronze (UNS C 54400) or special brass	–	–	1.5
Hexagonal nut		●			Brass (UNS C 38500)	–	3	–
	●		●	●	Aluminium alloy (AA 6262A or AA 6023)	–	5	–
Male crimp contact		●			Brass (UNS C 34500)	–	–	1.0
Female crimp contact		●			Bronze (UNS C 54400)	–	–	1.5
Clips		●			Cu-Be or special steel	without treatment		
Insulator		●			PEEK			
Ratchet		●			Special PEEK			
O-ring	●		●	●	FPM/FKM (Viton®)			
	●	●			EPDM (HY●)			
		●			Silicone			
Sealing resin	●	●	○		Epoxy (Araldite®) (HE●)			
	●	●			Silicone (Elastosil®) (HY●)			
Cable rear seal		●			Fluorosilicone			
Spring		●			Stainless steel			

Note: standards for surface treatment are as follows: chrome-plated SAE AMS 2460; nickel-plated SAE AMS QQ N 290 or MIL DTL 32119; gold-plated ISO 27874.

¹⁾ X = Nickel-plated aluminium alloy (standard).

C = Chrome-plated brass.

L = Anodized aluminium.

I = NiCorAl™ Nickel fluorocarbon polymer aluminium alloy.

²⁾ anthracite colour.

● First choice alternative ○ Special order alternative

Electrical performance

Characteristics	Value	IEC international	MIL-spec tests
Insulation resist. (at ambient temp.) ¹⁾	> 10 ¹² Ω, > 10 ¹⁰ Ω (after humidity)	IEC 60512-2 test 3a	EIA-364-21
Dielectric withstanding volt. (sea level)	See table pages 24 to 28	IEC 60512-2 test 4a	EIA-364-20
Contact resistance ³⁾	See table below	IEC 60512-2 test 2a	EIA-364-06
Current rating	See insulator configuration pages 24 to 28	IEC 60512-3 test 5a	
Shell to shell conductivity ²⁾	< 1.5m Ω	IEC 60512-2-6	EIA-364-83
Shielding effectiveness, low frequency ²⁾	≥ 80 dB up to 1GHz		EIA-364-66
Shielding effectiveness, high frequency ²⁾	≥ 70 dB (3GHz), ≥ 58 dB (6GHz), ≥ 40 dB (10GHz)		EIA-364-66

Contact resistance ³⁾ IEC 60512-2 test 2a								Value
0.5	0.7	0.9	1.3	4.0	5.0	6.0	8.0	ø A (mm)
≤ 8.3	≤ 5.7	≤ 4.2	≤ 2.9	≤ 0.3	≤ 0.25	≤ 0.2	≤ 0.2	mΩ

Note: ¹⁾ after humidity test: 21 days at 95% RH according to IEC 60068-2. Insulation resistance measured between the contacts and contact/shell.

²⁾ no shell to shell conductivity for anodized aluminium versions (shielding and conductivity values do not apply).

³⁾ after 3000 mating cycles and the salt spray test according to IEC 60512-6 test 11 f.

Mechanical performance

Characteristics	Value	IEC international	MIL-spec tests
Endurance	3000 cycles	IEC 60512-5 test 9a	EIA-364-09
Gunfire vibration	25 to 2000 Hz, 3 axis (Apache helicopter)		MIL-STD-810F method 519.5
Vibration-Sine ^{1) 2)}	30 g, 3 axis, 12 hr		MIL-STD-202 method 204-G
Vibration-Random ²⁾	50-2000 Hz, 37.8 g rms-3 axes; 4h amb	IEC 60512-6-4	EIA-364-28 test cond. V letter I
Shock ²⁾	300 g - 3 msec	IEC 60512-6-3	EIA-364-27 condition D
Acceleration	50 g acceleration		MIL-STD-1344 - 2011-1, A
Torque	See table below		

Note:

¹⁾ amplitude: 30g. Frequency: 10 to 2000 Hz. Time per axis: 4 hours (X, Y, Z).

²⁾ no signal discontinuity above 1 μs.

Plug mating/unmating torque

Series	Coupling torque tightening (N.cm)	Coupling torque untightning (N.cm)	Series	Coupling torque tightening (N.cm)	Coupling torque untightning (N.cm)
MM	8	4	TM	26	30
OM	4	5	4M	26	25
1M	10	11	LM	48	43
2M	20	14	5M	91	54
3M	34	29			

Note: indicative values, tightening torque may vary depending on insert configuration.

Environmental performance

Characteristics	Value	IEC international	MIL-spec tests
Standard models operating temperature (mated)	-55°C/+200°C (shell material code C + Silicone O-ring)		
	-20°C/+200°C (shell material code I/X + FPM O-ring)		
Ingress protection index (mated)	IP68 (at 2 m, 15Hr)	IEC 60529	
Fungus	Satisfied - by material analysis		MIL-STD 810F-508.5
Flammability	60 sec. front and back face		EIA-364-104A
Fluid contamination ¹⁾	Fuels, gasoline, hydraulic oils, solvents, de-icing		MIL-STD-810F method 504
Sand and dust ²⁾	6 hr, 55°C, blowing < 150 μm dust		MIL-STD 810F-510.4
Lightning strike	10 K amps - 6 times		EIA-364-75
Altitude-low temp ³⁾	-65°C; 40'000 feet and 400 VAC		EIA-364-105A
Salt fog ⁴⁾	48 hours (shell material code X/L)	IEC 60512-6 test 11f	EIA-364-26
	500 hours (shell material code I)	IEC 60512-6 test 11f	EIA-364-26
	> 1000 hours (shell material code C)	IEC 60512-6 test 11f	EIA-364-26
Thermal shock (standard models)	5 cycles: -65°C to +150°C	IEC 60512-11-4	EIA-364-32 test condition IV
Altitude immersion	No moisture on contacts		EIA-364-03
Humidity	21 days at 95%	IEC 60068-2	EIA-364-31 method IV
Safety	IP2X finger protection for high power connectors	IEC 60529	

Note:

¹⁾ connectors immersed at both 70°C and 25°C according to specification. Connectors are then inspected, no visual signs of damage seen.

Fuels: Kerosene, JP4, (Nato F40) at 70°C +/- 2°C. Gasoline: ASTM 4814. Hydraulic oils: Mineral oil based MIL-H-5606.

Solvents: Isopropanol. De-icing fluids: 25% ethylene glycol.

²⁾ no signs of damage, connectors opened and closed without difficulty. Dust or sand was not inside connector.

³⁾ wired mated connectors = no voltage breakdown, shell to all contacts (connected together) w/400 VAC after 1 hour at -65° C at 40'000 feet altitude.

⁴⁾ corrosion resistance. Inspection: salt deposits shall be removed by gentle wash in running water with light brushing using soft brush.

M series

The M Series connector offers a new innovative design for avionics, aerospace, military, security, motorsport and heavy duty applications. When selected in one of the high-strength aluminium options, this connector is one of the lightest and most compact of the LEMO product line. A one-grip ratchet locking system enables quick and secure coupling of the connectors. The arctic grip makes it easy to manipulate the connector while wearing gloves or when the connector is located in a difficult to access area.

Features:

- Ratchet-coupling mechanism (less than 3/4 turn to seat)
- Compact design for space savings
- Oil and fuel resistant
- 360° screening for full EMC shielding
- Colour coding / keying
- Scoop proof
- Threaded for MIL-DTL-38999M (series III) backshell
- Lightweight
- High vibration and shock resistance
- Sealed to IP68 when mated
- Standard or reverse gender configuration available
- Pin configuration from 2 to 114 contacts

Standard models (page 7)

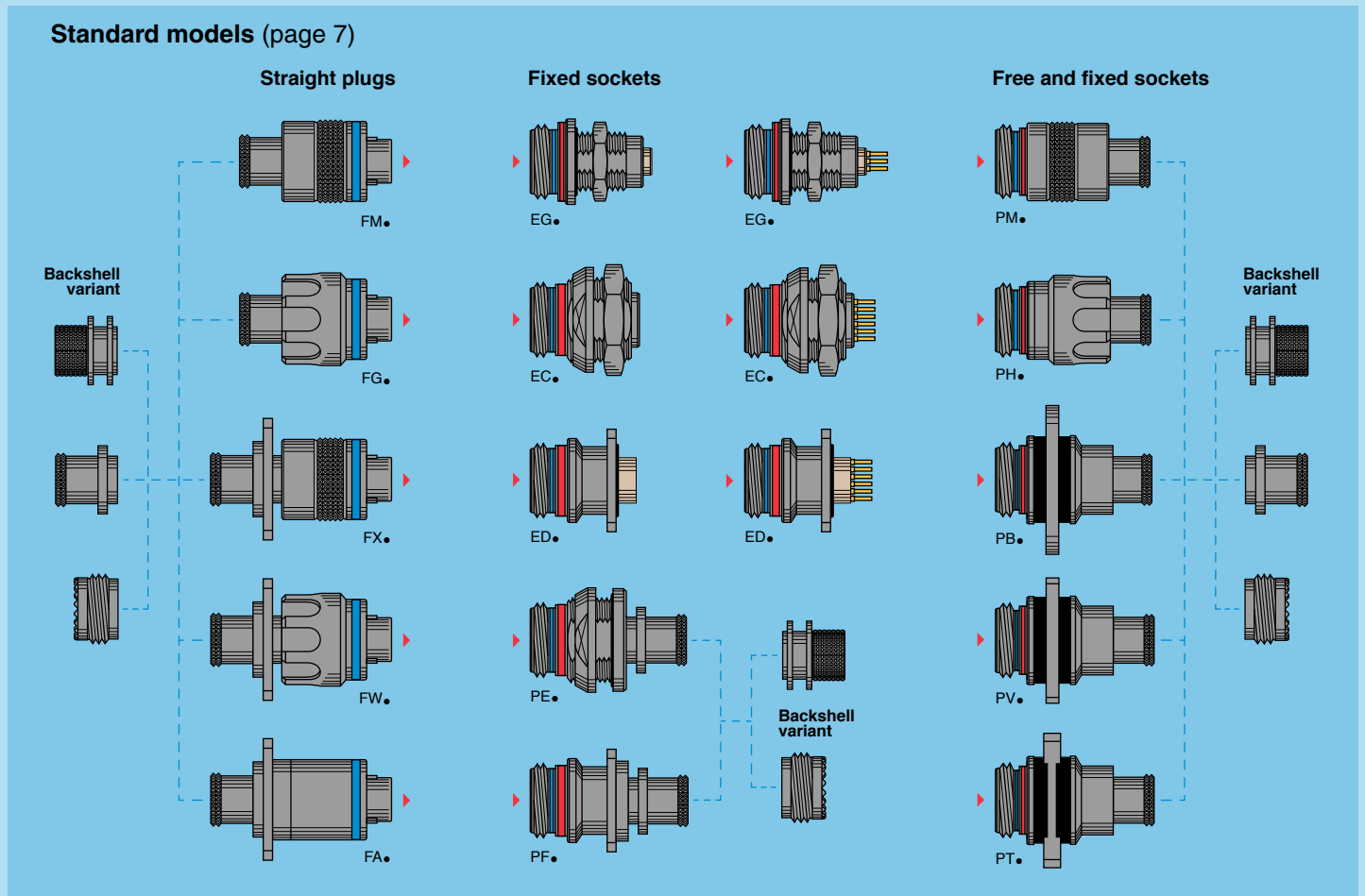

Watertight model (page 14)

Fixed socket

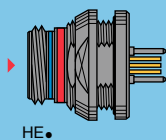

Vacuumtight model (page 15)

Fixed socket

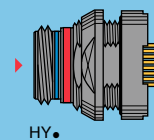

High Speed models (page 16)

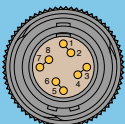

USB 2.0 models (page 18)

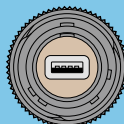

Fibre Optic models (page 19)

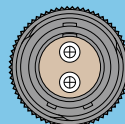

High Power models (page 21)

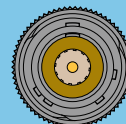

Standard models part numbering system

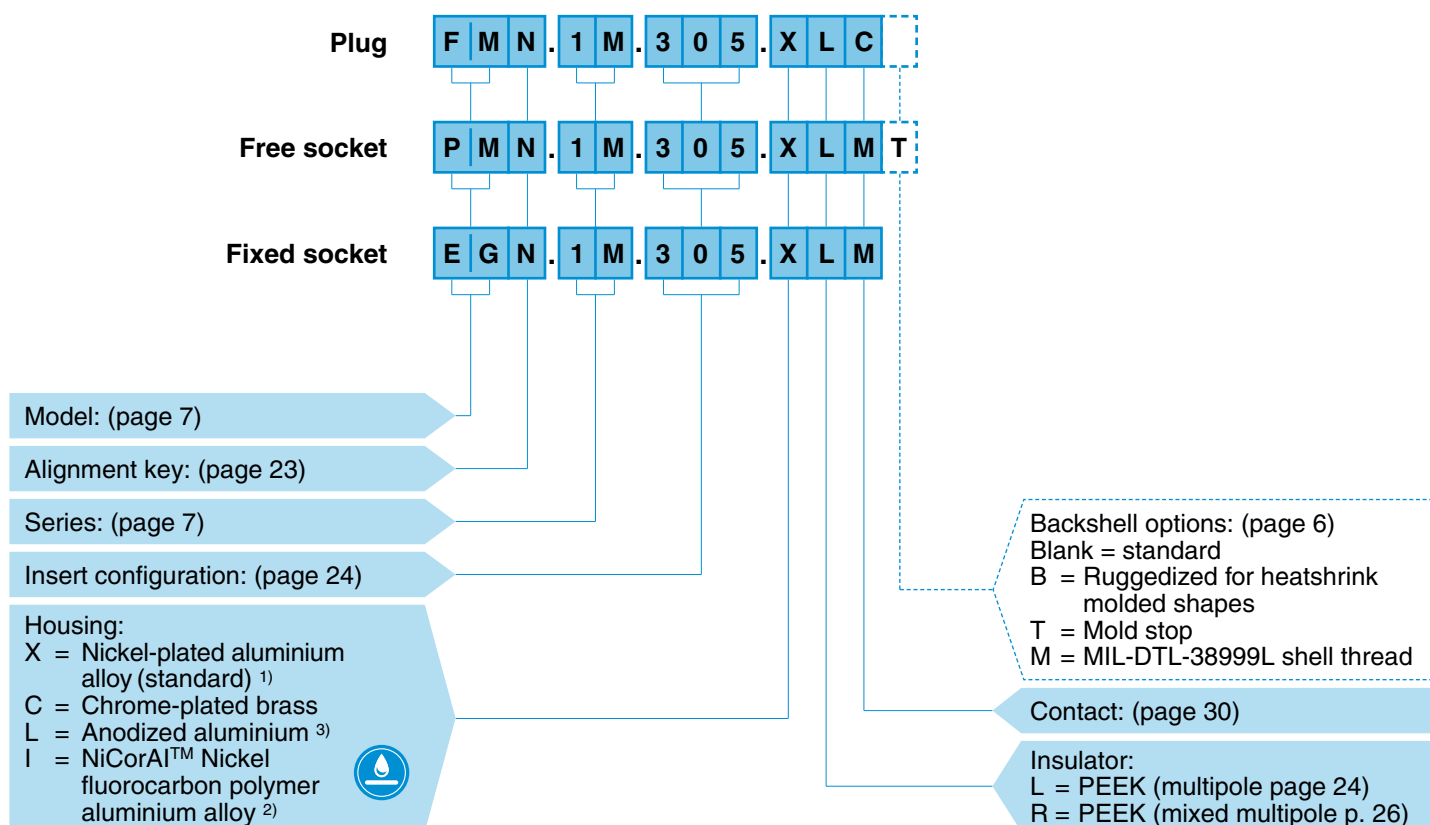

FMN.1M.305.XLC = straight plug with key (N), knurled grip, 1M series, multipole type with 5 contacts, outer shell in anthracite nickel-plated aluminium alloy, PEEK insulator, male crimp contacts.

PMN.1M.305.XLMT = free socket with key (N), knurled grip, 1M series, multipole type with 5 contacts, outer shell in anthracite nickel-plated aluminium alloy, PEEK insulator, female crimp contacts and mold stop.

EGN.1M.305.XLM = fixed socket with key (N), 1M series, multipole type with 5 contacts, outer shell in anthracite nickel-plated aluminium alloy, PEEK insulator, female crimp contact.

Note: ¹⁾ anthracite colour / 48 hours salt fog resistance.
²⁾ anthracite colour / 500 hours salt fog resistance RoHS 2/REACH.
³⁾ these connectors are designed for use with non-shielded cables as anodization is non conductive.

Others models part numbering system

- **Watertight** (page 14)
- **USB 2.0** (page 18)
- **Vacuumtight** (page 15)
- **Fibre Optic** (page 19)
- **High Speed** (page 16)
- **High Power** (page 21)

Part section showing internal components

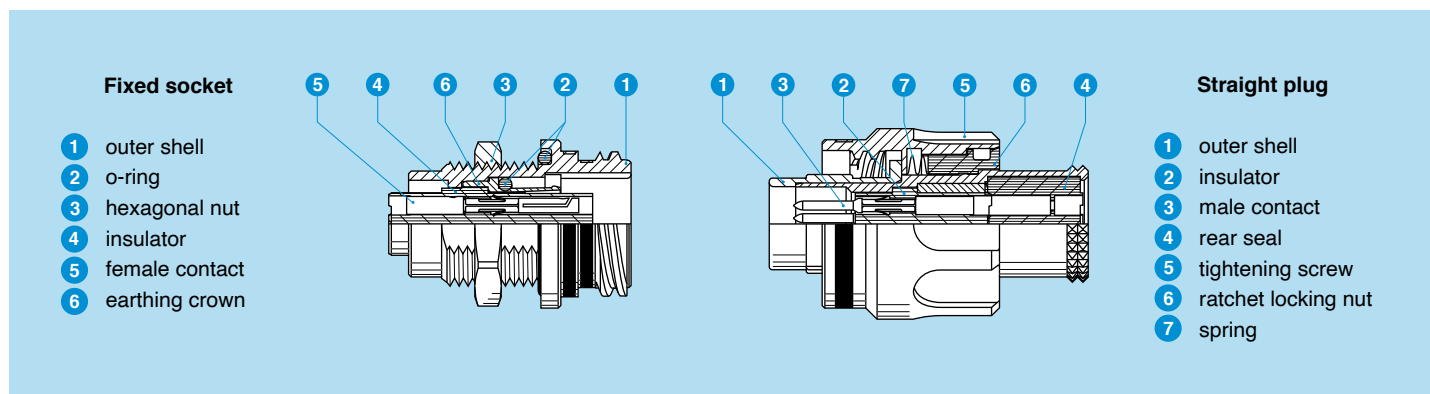

Locking nuts options

M Series connectors offers 2 different options for coupling nut allowing to adapt ergonomics according to use cases.

- The Knurled grip is the default choice for most applications as it offers a good level of grip whilst keeping a very compact overall plug diameter.
- The Arctic grip offers maximum ergonomics enabling easy manipulation even with gloves.

Knurled grip (standard)

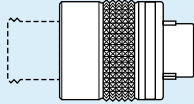

Arctic grip (variant)

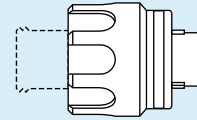

Backshell options

M Series connectors offers 4 different backshell options allowing for various cable assembly attachments.

- The standard backshell offers a simple design allowing to either use a crimp ring or a spring for shielding attachment. This is the default option if no specific termination is specified.
- The Mold stop offers a special geometry enabling over molding termination for a clean and rugged cable assembly finish.
- The Heat shrink molded shape offers the matching geometry to guarantee a perfect fit with heat shrink molded boots (see page 35).
- The MIL-DTL-38999M (series III) offers the matching screw geometry allowing the use of standard D38999 compatible backshells.

Standard

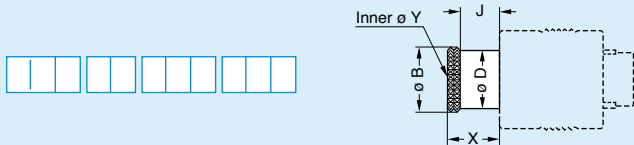

Mold stop

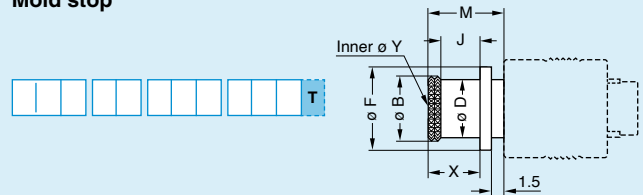

Heatshrink molded shapes

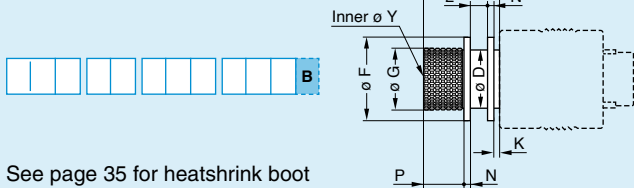

MIL-DTL-38999M (series III)

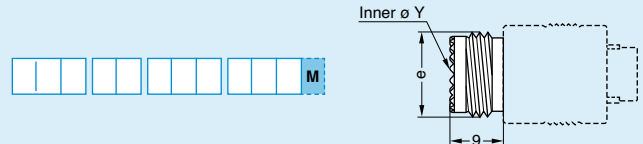

Series	Backshell variant dimensions (mm)												Code 1)
	B	D	e	F	G	J	K	M	N	P	X	Y	
MM	6.4	5.6	–	7.8	6.0	4.2	0.7	8.8	0.55	5.0	5.8	4.7	–
0M	8.8	8.0	–	10.7	8.4	5.1	0.7	9.7	0.60	5.8	6.7	6.6	–
1M	10.5	9.7	M12x1.0	12.4	10.1	5.1	0.7	9.7	0.60	5.8	6.7	8.3	A
2M	14.0	13.0	M15x1.0	15.5	13.4	5.1	0.7	10.1	0.80	5.8	7.1	11.6	B
3M	16.0	15.0	M18x1.0	17.5	15.4	5.1	0.7	10.1	0.80	5.8	7.1	13.6	C
TM	17.9	16.7	M18x1.0	19.8	17.1	5.2	0.8	10.6	1.00	5.8	7.6	14.6	C
4M	20.7	19.5	M22x1.0	22.6	19.9	5.2	0.8	10.6	1.00	5.8	7.6	17.6	D
LM	23.9	22.7	M25x1.0	25.8	23.1	5.2	0.8	10.6	1.00	5.8	7.6	20.6	E
5M	29.7	28.5	M31x1.0	31.4	28.9	5.2	0.8	10.6	1.00	5.8	7.6	26.6	G

Note: 1) MIL-DTL-38999M (series III) backshell connector size code (backshell not supplied) (not available in MM and 0M size).



Standard models

F●● Straight plug

FM●

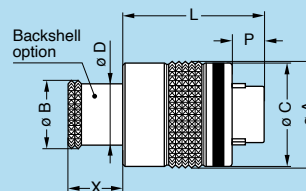

FG●

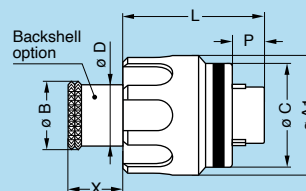

Reference		Dimensions (mm)							
Model	Series	A	A1	B	C	D	L	P	X
F●●	MM	11.1	12.0	6.4	10.7	5.6	15.5	5.5	5.8
F●●	0M	13.1	14.4	8.8	12.7	8.0	17.4	3.9	6.7
F●●	1M	14.6	15.9	10.5	14.2	9.7	17.4	3.9	6.7
F●●	2M	17.6	18.9	14.0	17.2	13.0	17.4	3.9	7.1
F●●	3M	19.6	20.9	16.0	19.2	15.0	17.4	3.9	7.1
F●●	TM	22.5	23.4	17.9	22.0	16.7	21.0	3.4	7.6
F●●	4M	25.0	25.9	20.7	24.5	19.5	21.0	3.4	7.6
F●●	LM	28.5	29.4	23.9	28.0	22.7	21.0	3.4	7.6
F●●	5M	34.0	34.9	29.7	33.5	28.5	21.0	3.4	7.6

Note: B, D and X dimensions are for standard backshell. For different backshell option see page 6.

F●● Straight plug with square flange (these models are not IP68 due to the absence of panel sealing)

FX●

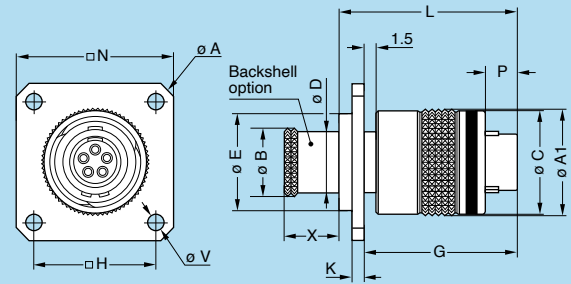

FW●

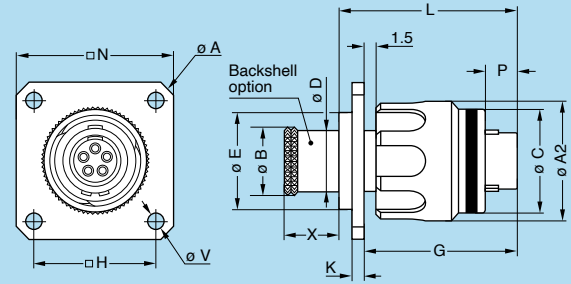

FA● Non-locking straight plug

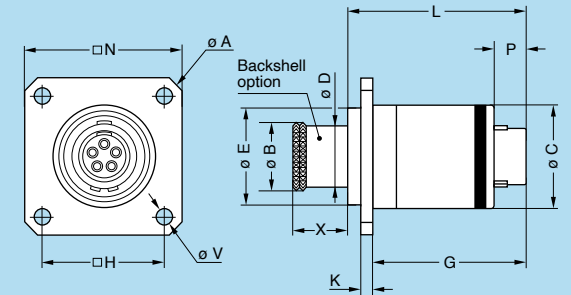

Note: for integration in a rackable application please contact us for detailed informations linked to coupling constrains.

Reference		Dimensions (mm)														
Model	Series	A	A1	A2	B	C	D	E	G	H	K	L	N	P	V	X
F●●	MM	21.5	11.1	12.0	6.4	10.7	5.6	9.5	17.0	12.0	1.5	20.3	17.0	5.5	2.7	5.8
F●●	0M	26.9	13.1	14.4	8.8	12.7	8.0	12.2	18.9	15.1	1.5	22.4	20.6	3.9	2.7	6.7
F●●	1M	31.4	14.6	15.9	10.5	14.2	9.7	13.7	18.9	18.3	1.5	22.4	23.8	3.9	3.3	6.7
F●●	2M	34.6	17.6	18.9	14.0	17.2	13.0	16.7	18.9	20.6	1.5	22.4	26.1	3.9	3.3	7.1
F●●	3M	34.6	19.6	20.9	16.0	19.2	15.0	18.7	18.9	20.6	1.5	22.4	26.1	3.9	3.3	7.1
F●●	TM	38.0	22.5	23.4	17.9	22.0	16.7	21.5	22.5	23.0	2.0	27.2	28.5	3.4	3.3	7.6
F●●	4M	40.3	25.0	25.9	20.7	24.5	19.5	24.0	22.5	24.6	2.0	27.2	30.1	3.4	3.3	7.6
F●●	LM	43.7	28.5	29.4	23.9	28.0	22.7	27.5	22.5	27.0	2.0	27.2	32.5	3.4	3.3	7.6
F●●	5M	47.0	34.0	34.9	29.7	33.5	28.5	33.0	22.5	29.4	2.0	27.2	37.0	3.4	3.3	7.6

Note: B, D and X dimensions are for standard backshell. For different backshell option see page 6.

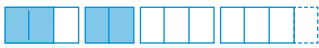

EG● Fixed socket, nut fixing

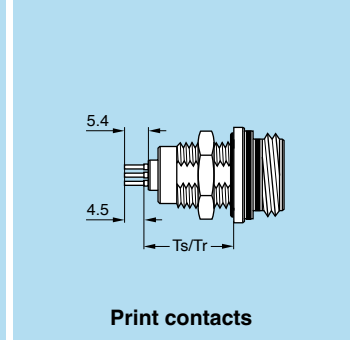
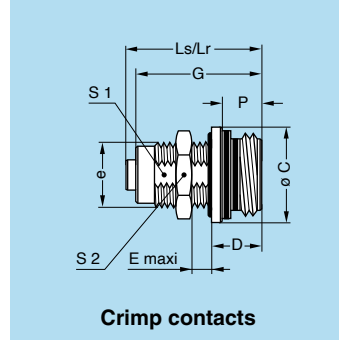

Reference		Dimensions (mm)											
Model	Series	C	D	e	E	G	Ls	Lr	P	S1	S2	Ts	Tr
EG●	MM	10.7	5.2	M7x0.5	4.5	13.8	15.0	15.0	3.7	6.3	9.0	10.7	–
EG●	0M	12.7	6.8	M9x0.6	5.0	16.8	18.3	18.3	5.3	8.2	11.0	12.4	–
EG●	1M	14.2	6.8	M11x1.0	4.5	16.8	18.3	18.3	5.3	9.5	13.0	12.4	–
EG●	2M	17.2	6.8	M14x1.0	4.5	16.8	18.3	18.3	5.3	12.5	17.0	12.4	–
EG●	3M	19.2	6.8	M16x1.0	4.0	16.8	18.3	18.3	5.3	14.5	19.0	12.4	–
EG●	TM	22.0	9.4	M18x1.0	4.0	18.9	20.0	21.9	7.9	16.5	22.0	11.5	13.4
EG●	4M	24.5	9.4	M21x1.0	4.0	18.9	20.0	21.9	7.9	19.5	25.0	11.5	13.4
EG●	LM	28.0	9.4	M24x1.0	4.0	18.9	20.0	21.9	7.9	22.5	30.0	11.5	13.4
EG●	5M	33.5	9.4	M30x1.0	4.0	18.9	20.0	21.9	7.9	28.5	36.0	11.5	13.4

Panel cut-out (page 41).

PCB drilling pattern (page 42).

Note: Ls = standard gender, Lr = reverse gender (see page 23 for standard/reverse gender options).

EC● Fixed socket with two nuts (these models are not IP68 due to the absence of panel sealing)

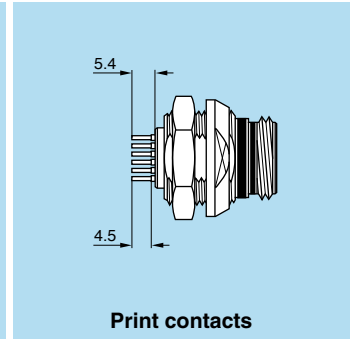
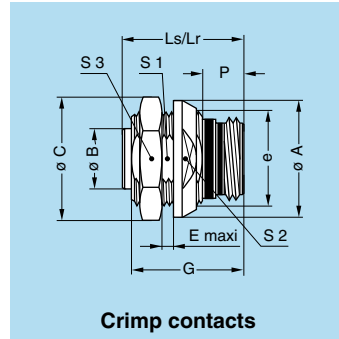

Reference		Dimensions (mm)											
Model	Series	A	B	C	E	e	G	Ls	Lr	P	S1	S2	S3
EC●	MM	14.0	2.85	13.5	5.0	M10x0.50	13.8	15.0	15.0	3.7	9.0	11.0	12.0
EC●	0M	17.0	4.72	18.2	5.0	M13x0.75	16.8	18.3	18.3	5.3	11.5	14.0	16.0
EC●	1M	18.0	5.95	19.2	5.0	M14x1.00	16.8	18.3	18.3	5.3	12.5	16.0	17.0
EC●	2M	21.0	8.95	21.5	4.0	M17x1.00	16.8	18.3	18.3	5.3	15.5	18.0	19.0
EC●	3M	23.0	10.95	25.0	4.0	M19x1.00	16.8	18.3	18.3	5.3	17.5	20.0	22.0
EC●	TM	27.0	12.30	28.0	2.5	M22x1.00	18.9	20.0	21.9	7.9	20.5	23.0	25.0
EC●	4M	29.0	13.95	34.0	2.5	M24x1.00	18.9	20.0	21.9	7.9	22.5	25.0	30.0
EC●	LM	33.0	17.95	36.0	2.5	M28x1.00	18.9	20.0	21.9	7.9	26.5	29.0	32.0
EC●	5M	38.0	22.90	41.0	2.5	M33x1.00	18.9	20.0	21.9	7.9	31.5	34.0	37.0

Panel cut-out (page 41).

PCB drilling pattern (page 42).

Note: Ls = standard gender, Lr = reverse gender (see page 23 for standard/reverse gender options).

ED● Fixed socket with square flange

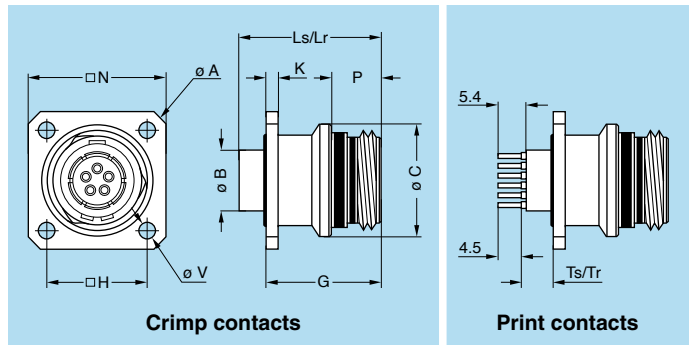

Reference		Dimensions (mm)												
Model	Series	A	B	C	G	H	K	Ls	Lr	N	P	Ts	Tr	V
ED●	MM	18.6	4.70	10.7	13.8	9.5	1.5	17.0	17.0	14.5	3.7	4.1	–	2.7
ED●	0M	20.6	4.72	12.7	14.3	11.0	1.5	18.3	18.3	16.0	5.3	4.9	–	2.7
ED●	1M	23.8	5.95	14.2	14.3	12.9	1.5	18.3	18.3	18.4	5.3	4.9	–	3.3
ED●	2M	26.9	8.95	17.2	14.3	15.1	1.5	18.3	18.3	20.6	5.3	4.9	–	3.3
ED●	3M	29.0	10.95	19.2	14.3	16.6	1.5	18.3	18.3	22.1	5.3	4.9	–	3.3
ED●	TM	31.4	12.30	22.0	16.5	18.3	2.0	20.0	21.9	23.8	7.9	4.4	6.3	3.3
ED●	4M	34.6	13.95	24.5	16.5	20.6	2.0	20.0	21.9	26.1	7.9	4.4	6.3	3.3
ED●	LM	38.0	17.95	28.0	16.5	23.0	2.0	20.0	21.9	28.5	7.9	4.4	6.3	3.3
ED●	5M	43.7	22.90	33.5	16.5	27.0	2.0	20.0	21.9	32.5	7.9	4.4	6.3	3.3

Panel cut-out (page 41).

PCB drilling pattern (page 42).

Note: Ls = standard gender, Lr = reverse gender (see page 23 for standard/reverse gender options).

PE● Fixed socket, nut fixing (back panel mounting)

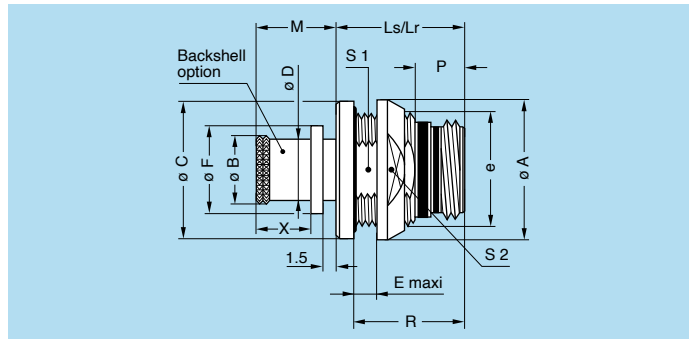

Reference		Dimensions (mm)																
Model	Series	A	B	C	D	E	F	e	Ls	Lr	Ls ¹⁾	Lr ¹⁾	M	P	R	S1	S2	X
PE●	MM	14.0	6.4	13.8	5.6	4.0	7.8	M10x0.50	12.6	12.6	–	–	8.8	3.7	10.5	9.0	11.0	5.8
PE●	0M	17.0	8.8	16.8	8.0	5.0	10.7	M13x0.75	15.9	15.9	–	–	9.7	5.3	13.8	11.5	14.0	6.7
PE●	1M	18.0	10.5	17.8	9.7	5.0	12.4	M14x1.00	15.9	15.9	17.4	17.4	9.7	5.3	13.8	12.5	16.0	6.7
PE●	2M	21.0	14.0	20.8	13.0	5.0	15.5	M17x1.00	15.9	15.9	17.4	17.4	10.1	5.3	13.8	15.5	18.0	7.1
PE●	3M	23.0	16.0	22.8	15.0	5.0	17.5	M19x1.00	15.9	15.9	17.4	17.4	10.1	5.3	13.8	17.5	20.0	7.1
PE●	TM	27.0	17.9	25.8	16.7	4.0	19.8	M22x1.00	18.9	19.5	19.2	21.1	10.6	7.9	16.9	20.5	23.0	7.6
PE●	4M	29.0	20.7	27.8	19.5	4.0	22.6	M24x1.00	18.9	19.5	19.2	21.1	10.6	7.9	16.9	22.5	25.0	7.6
PE●	LM	33.0	23.9	31.8	22.7	4.0	25.8	M28x1.00	18.9	19.5	19.2	21.1	10.6	7.9	16.9	26.5	29.0	7.6
PE●	5M	38.0	29.7	36.8	28.5	4.0	31.4	M33x1.00	18.9	19.5	19.2	21.1	10.6	7.9	16.9	31.5	34.0	7.6

Panel cut-out (page 41).

Note: Ls = standard gender, Lr = reverse gender (see page 23 for standard/reverse gender options).

This model is not available with standard backshell option (backshell not supplied). For different backshell option see page 6.

¹⁾ Dimensions for MIL-DTL-38999M (series III) backshell connector size code (backshell not supplied) (not available in MM and 0M size).

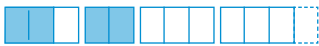

PF● Fixed socket with square flange (these models are not IP68 due to the absence of panel sealing)

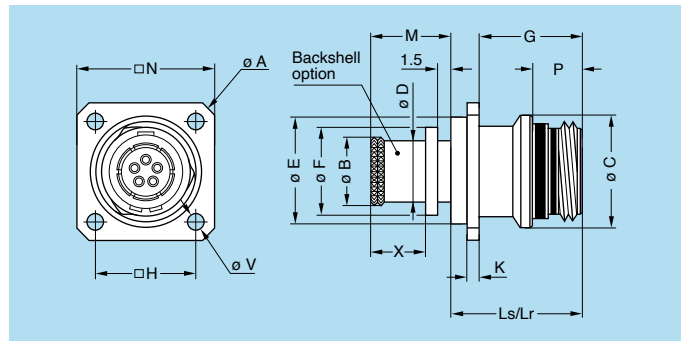

Reference		Dimensions (mm)																	
Model	Series	A	B	C	D	E	F	G	H	K	Ls	Lr	Ls ¹⁾	Lr ¹⁾	M	N	P	V	X
PF●	MM	18.6	6.4	10.7	5.6	7.8	7.8	12.3	9.5	1.5	15.6	15.6	-	-	8.8	14.5	3.7	2.7	5.8
PF●	0M	20.6	8.8	12.7	8.0	10.7	10.7	12.8	11.0	1.5	15.9	15.9	-	-	9.7	16.0	5.3	2.7	6.7
PF●	1M	23.8	10.5	14.2	9.7	12.4	12.4	12.8	12.9	1.5	15.9	15.9	17.5	17.5	9.7	18.4	5.3	3.3	6.7
PF●	2M	26.9	14.0	17.2	13.0	15.5	15.5	12.8	15.1	1.5	15.9	15.9	17.5	17.5	10.1	20.6	5.3	3.3	7.1
PF●	3M	29.0	16.0	19.2	15.0	17.5	17.5	12.8	16.6	1.5	15.9	15.9	17.5	17.5	10.1	22.1	5.3	3.3	7.1
PF●	TM	31.4	17.9	22.0	16.7	19.8	19.8	14.5	18.3	2.0	18.9	19.5	19.2	21.1	10.6	23.8	7.9	3.3	7.6
PF●	4M	34.6	20.7	24.5	19.5	22.6	22.6	14.5	20.6	2.0	18.9	19.5	19.2	21.1	10.6	26.1	7.9	3.3	7.6
PF●	LM	38.0	23.9	28.0	22.7	25.8	25.8	14.5	23.0	2.0	18.9	19.5	19.2	21.1	10.6	28.5	7.9	3.3	7.6
PF●	5M	47.0	29.7	33.5	28.5	33.0	31.4	14.5	29.4	2.0	18.9	19.5	19.2	21.1	10.6	37.0	7.9	3.3	7.6

Panel cut-out
(page 41).

Note: Ls = standard gender, Lr = reverse gender (see page 23 for standard/reverse gender options).
 This model is not available with standard backshell variant (backshell not supplied). For different backshell option see page 6.
¹⁾ Dimensions for MIL-DTL-38999M (series III) backshell connector size code (backshell not supplied) (not available in MM and 0M size).

P●● Free socket

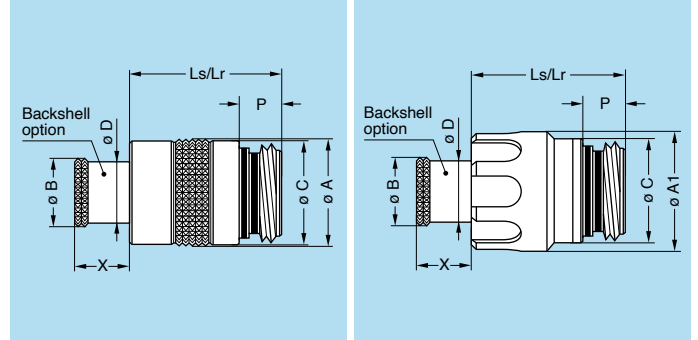

Reference		Dimensions (mm)								
Model	Series	A	A1	B	C	D	Ls	Lr	P	X
P●●	MM	11.1	12.0	6.4	10.7	5.6	15.6	15.6	3.7	5.8
P●●	0M	13.1	14.4	8.8	12.7	8.0	18.9	18.9	5.3	6.7
P●●	1M	14.6	15.9	10.5	14.2	9.7	18.9	18.9	5.3	6.7
P●●	2M	17.6	18.9	14.0	17.2	13.0	18.9	18.9	5.3	7.1
P●●	3M	19.6	20.9	16.0	19.2	15.0	18.9	18.9	5.3	7.1
P●●	TM	22.5	23.4	17.9	22.0	16.7	20.6	22.5	7.9	7.6
P●●	4M	25.0	25.9	20.7	24.5	19.5	20.6	22.5	7.9	7.6
P●●	LM	28.5	29.4	23.9	28.0	22.7	20.6	22.5	7.9	7.6
P●●	5M	34.0	34.9	29.7	33.5	28.5	20.6	22.5	7.9	7.6

Note: Ls = standard gender, Lr = reverse gender (see page 23 for standard/reverse gender options).
B, D and X dimensions are for standard backshell. For different backshell option see page 6.

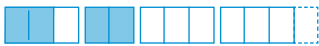

P●● Fixed socket with antivibration flange (these models are not IP68 due to the absence of panel sealing)

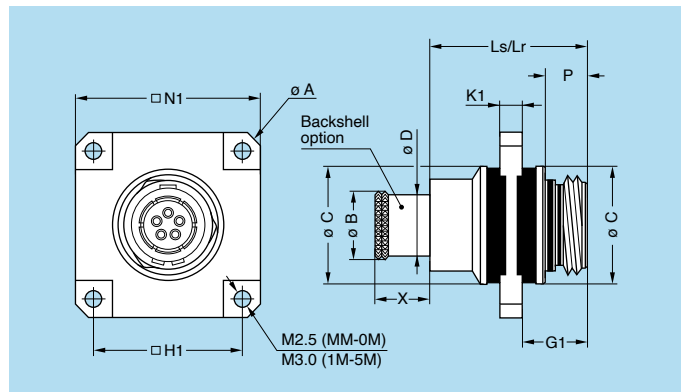
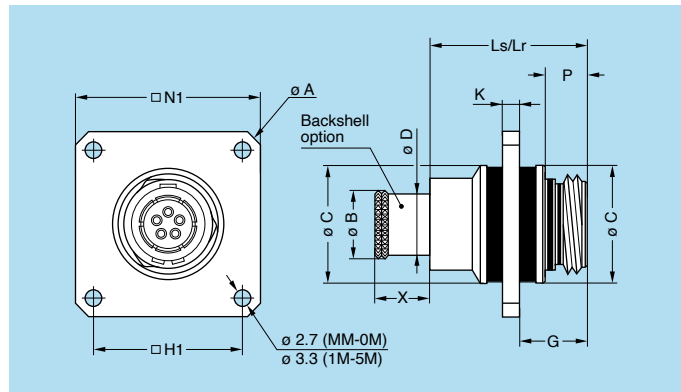
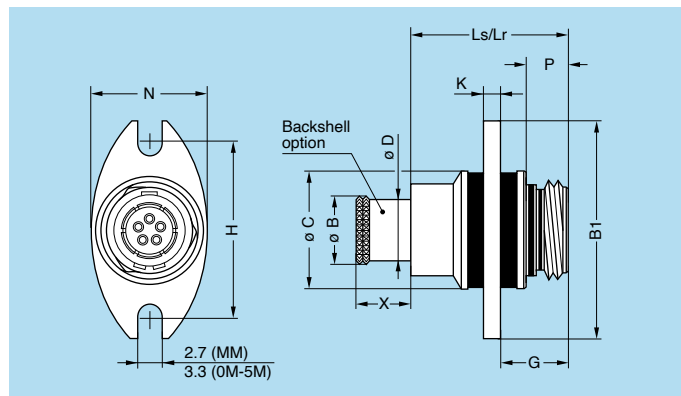

Reference		Dimensions (mm)																				
Model	Series	A	B	B1	C	D	G	G1	H	H1	K	K1	N	N1	P	Ls	Lr	LS ¹⁾	LR ¹⁾	LS ²⁾	LR ²⁾	X
P●●	MM	21.5	6.4	21.0	11.3	5.6	6.7	6.0	16.2	12.0	1.5	3.0	12.5	17.0	3.7	15.6	15.6	15.6	15.6	—	—	5.8
P●●	0M	26.9	8.8	27.0	14.5	8.0	8.3	7.3	21.4	15.1	2.0	4.0	16.0	20.6	5.3	18.9	18.9	18.9	18.9	—	—	6.7
P●●	1M	31.4	10.5	29.0	16.5	9.7	8.3	7.3	23.4	18.3	2.0	4.0	18.0	23.8	5.3	18.9	18.9	18.9	18.9	18.5	18.5	6.7
P●●	2M	34.6	14.0	32.0	19.5	13.0	8.3	7.3	26.4	20.6	2.0	4.0	21.0	26.1	5.3	18.9	18.9	18.9	18.9	18.5	18.5	7.1
P●●	3M	38.0	16.0	35.0	21.5	15.0	8.3	7.3	29.0	23.0	2.0	4.0	23.0	28.5	5.3	18.9	18.9	18.9	18.9	18.5	18.5	7.1
P●●	TM	40.3	17.9	38.5	24.5	16.7	11.0	10.0	32.5	24.6	2.0	4.0	26.0	30.1	7.9	20.6	22.5	20.6	20.6	20.2	21.1	7.6
P●●	4M	43.7	20.7	41.0	27.5	19.5	11.0	10.0	35.0	27.0	2.0	4.0	29.0	32.5	7.9	20.6	22.5	20.6	20.6	20.2	21.1	7.6
P●●	LM	47.1	23.9	44.0	30.5	22.7	11.0	10.0	38.0	29.4	2.0	4.0	32.0	34.9	7.9	20.6	22.5	20.6	20.6	20.2	21.1	7.6
P●●	5M	54.9	29.7	51.0	37.5	28.5	11.0	10.0	45.0	34.9	2.0	4.0	39.0	40.4	7.9	20.6	22.5	20.6	20.6	20.2	21.1	7.6

Note: Ls = standard gender, Lr = reverse gender (see page 23 for standard/reverse gender options).

B, D and X dimensions are for standard backshell. For different backshell option see page 6.

¹⁾ Dimensions for mold stop and heatshrink molded shapes backshell option.

²⁾ Dimensions for MIL-DTL-38999M (series III) backshell connector size code (backshell not supplied) (not available in MM and 0M size).

Panel cut-out (page 41).

Watertight model (unmated)

Part numbering system

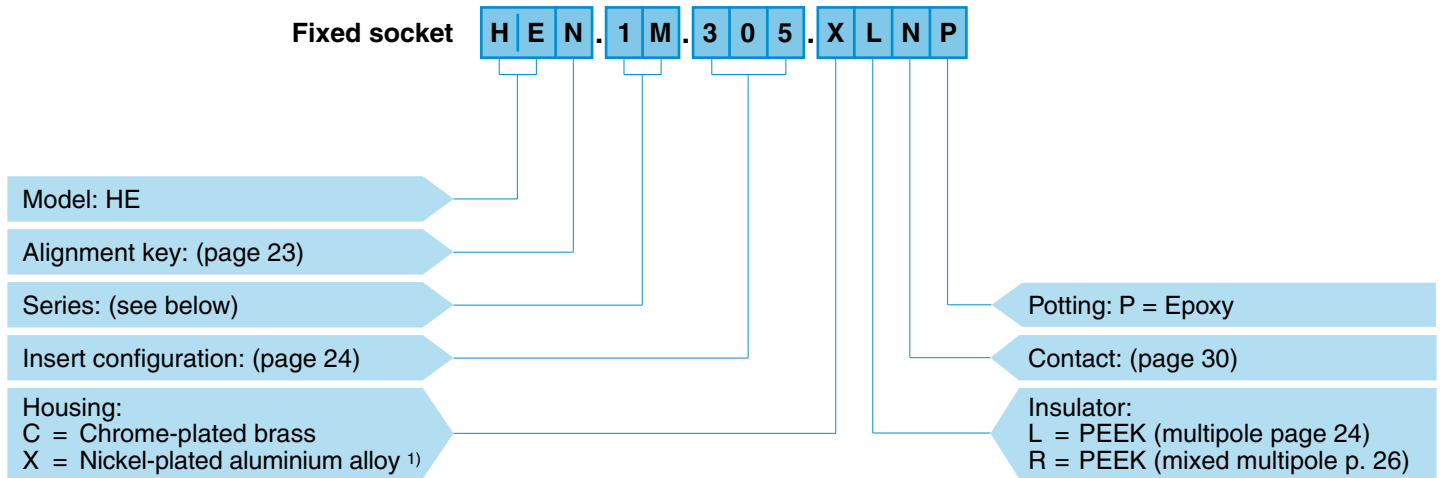

HEN.1M.305.XLNP = fixed socket, nut fixing, with key (N), 1M series, multipole type with 5 contacts, outer shell in anthracite nickel-plated aluminium alloy, PEEK insulator, female print contacts, watertight.

Note: ¹⁾ anthracite colour / 48 hours salt fog resistance.

Environmental performance

Characteristics	Value	Standard
Operating temperature	-20°C/+80°C	–

Characteristics	Value	Standard
Unmated ingress protection	IP68 (at 2 m, 15 Hr)	IEC 60529

HE● Fixed socket, nut fixing, key (N) or keys (H, P, R, S, T, U, V, W and X), for printed circuit, watertight (back panel mounting)

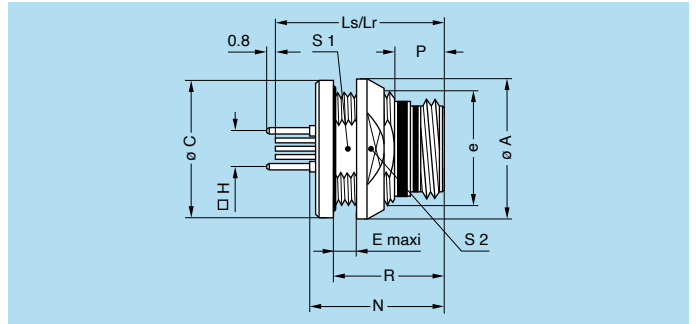

Reference		Dimensions (mm)											
Model	Series	A	C	e	E	H	Ls	Lr	N	P	R	S1	S2
HE●	MM	14.0	13.8	M10x0.50	4.0	5.08	20.4	20.4	15.3	3.7	10.5	9.0	11.0
HE●	0M	17.0	16.8	M13x0.75	5.0	5.08	20.8	21.0	16.8	5.3	13.8	11.5	14.0
HE●	1M	18.0	17.8	M14x1.00	5.0	7.62	20.8	21.0	16.8	5.3	13.8	12.5	16.0
HE●	2M	21.0	20.8	M17x1.00	5.0	8.89	20.8	21.0	16.8	5.3	13.8	15.5	18.0
HE●	3M	23.0	22.8	M19x1.00	5.0	10.16	20.8	21.0	16.8	5.3	13.8	17.5	20.0
HE●	TM	27.0	25.8	M22x1.00	4.0	12.70	24.6	24.6	19.9	7.9	16.9	20.5	23.0
HE●	4M	29.0	27.8	M24x1.00	4.0	13.97	24.6	24.6	19.9	7.9	16.9	22.5	25.0
HE●	LM	33.0	31.8	M28x1.00	4.0	16.51	24.6	24.6	19.9	7.9	16.9	26.5	29.0
HE●	5M	38.0	36.8	M33x1.00	4.0	20.32	24.6	24.6	19.9	7.9	16.9	31.5	34.0

Panel cut-out (page 41).

PCB drilling pattern (page 42).

Note: in MM series, the four external earth contacts are shorter.
Ls = standard gender, Lr = reverse gender (see page 23 for standard/reverse gender options).

Vacuumtight model (unmated)

Part numbering system

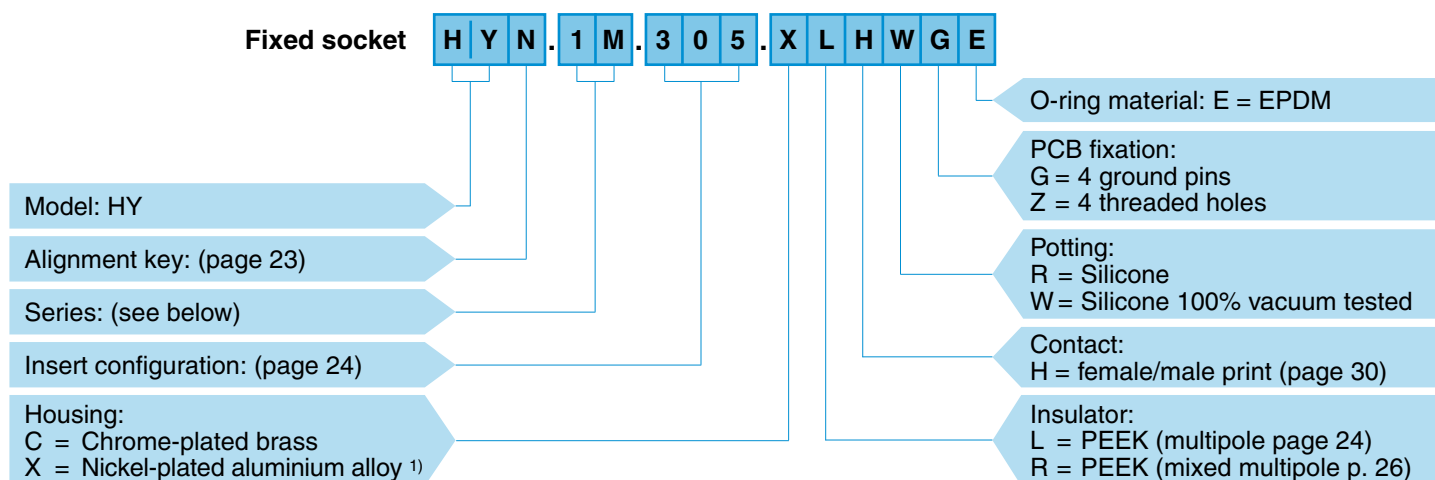

HYN.1M.305.XLHWGE = fixed socket, nut fixing, with key (N), 1M series, multipole type with 5 contacts, outer shell in anthracite nickel-plated aluminium alloy, PEEK insulator, female print contacts, vacuumtight, with 4 ground pins and a EPDM o-ring.

Note: ¹⁾ anthracite colour / 48 hours salt fog resistance.

Environmental performance

Characteristics	Value	Standard
Operating temperature	-55°C/+150°C	–

Characteristics	Value	Standard
Leakage rate	< 10 ⁻⁷ mbar·l·s ⁻¹	IEC 60512-7 test 14 b

HY● Fixed socket, nut fixing, key (N) or keys (H, P, R, S, T, U, V, W and X), for printed circuit, vacuumtight (back panel mounting)

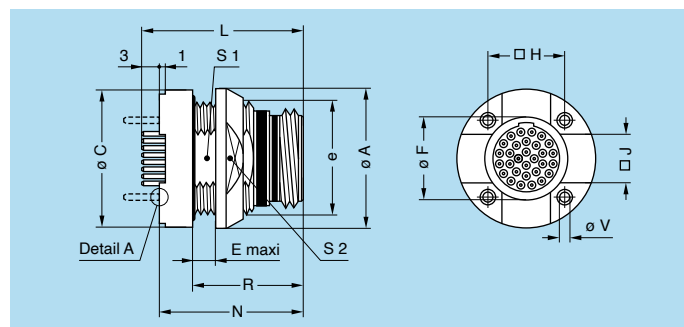

Reference		Dimensions (mm)												
Model	Series	A	C	e	E	F	H	J	L	N	R	S1	S2	V
HY●	MM	14.0	13.8	M10x0.50	4.0	5.7	6.35	3.0	19.1	16.1	10.5	9.0	11.0	M2x0.4
HY●	0M	17.0	16.8	M13x0.75	5.3	7.8	8.89	5.0	22.4	19.4	13.8	11.5	14.0	M2x0.4
HY●	1M	18.0	17.8	M14x1.00	5.3	8.8	10.16	5.5	22.4	19.4	13.8	12.5	16.0	M2x0.4
HY●	2M	21.0	20.8	M17x1.00	5.3	11.8	11.43	7.0	22.4	19.4	13.8	15.5	18.0	M2x0.4
HY●	3M	23.0	22.8	M19x1.00	5.3	13.8	12.70	8.0	22.4	19.4	13.8	17.5	20.0	M2x0.4
HY●	TM	27.0	25.8	M22x1.00	4.5	15.2	13.97	8.7	26.0	23.0	17.4	20.5	23.0	M3x0.5
HY●	4M	29.0	27.8	M24x1.00	4.5	16.8	15.24	9.5	26.0	23.0	17.4	22.5	25.0	M3x0.5
HY●	LM	33.0	31.8	M28x1.00	4.5	20.8	17.78	11.5	26.0	23.0	17.4	26.5	29.0	M3x0.5
HY●	5M	38.0	36.8	M33x1.00	4.5	25.9	21.59	14.0	26.0	23.0	17.4	31.5	34.0	M3x0.5

PCB fixation (Detail A)

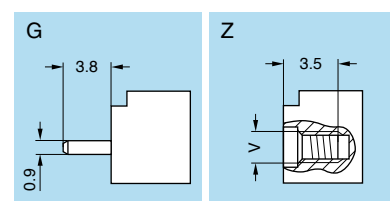

Panel cut-out (page 41).

PCB drilling pattern (page 44).

Note: special anti-vibration thread to be used with standard metric screws (not supplied).

High Speed models

Those configurations meet the Ethernet 10Gb/s data transfer requirements (CAT6, up to 250 MHz).

Part numbering system

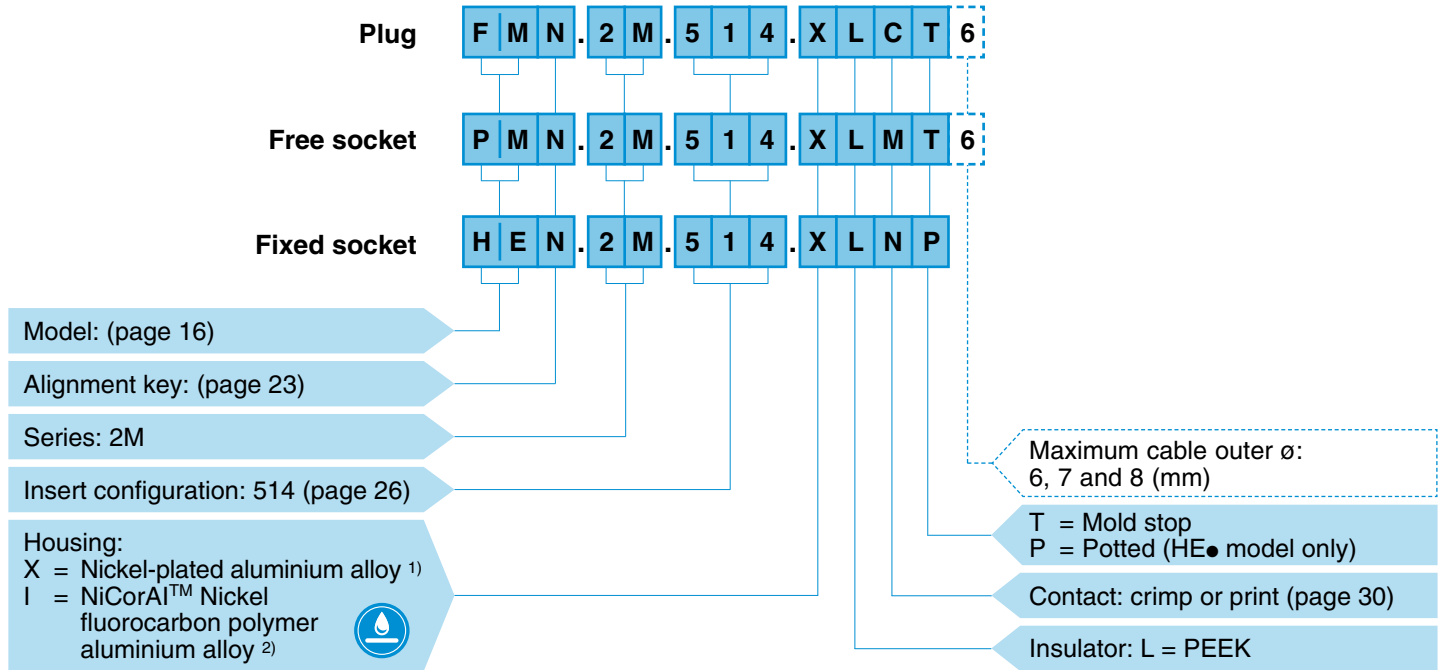

FMN.2M.514.XLCT6 = straight plug with key (N), knurled grip, 2M series, multipole type with 8 contacts, outer shell in anthracite nickel-plated aluminium alloy, PEEK insulator, male crimp contacts.

PMN.2M.514.XLMT6 = free socket with key (N), knurled grip, 2M series, multipole type with 8 contacts, outer shell in anthracite nickel-plated aluminium alloy, PEEK insulator, female crimp contacts and mold stop.

HEN.2M.514.XLNP = fixed socket, nut fixing, with key (N), 2M series, multipole type with 8 contacts, outer shell in anthracite nickel-plated aluminium alloy, PEEK insulator, female print contacts, watertight.

Note: ¹⁾ anthracite colour / 48 hours salt fog resistance. ²⁾ anthracite colour / 500 hours salt fog resistance RoHS 2/REACH.

FM●.2M.514 Straight plug, key (N) or keys (P and U) with knurled grip and mold stop

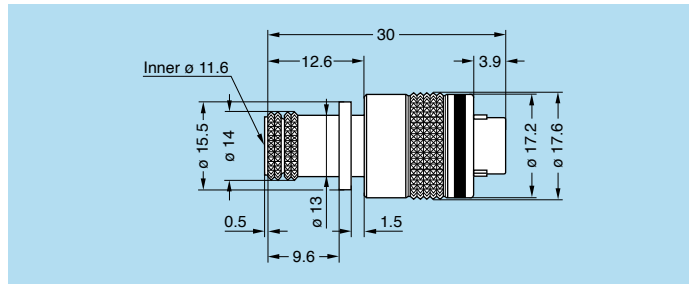

FG●.2M.514 Straight plug, key (N) or keys (P and U) with arctic grip and mold stop

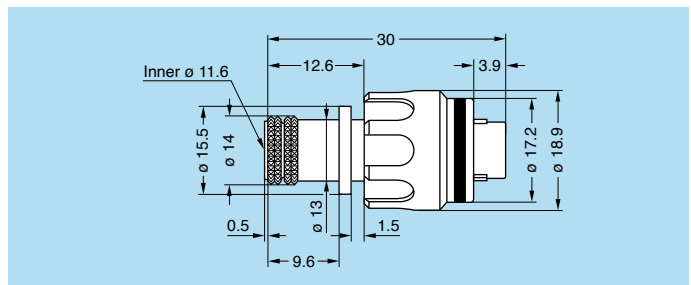

PE●.2M.514 Fixed socket, key (N) or keys (P and U) with mold stop (back panel mounting)

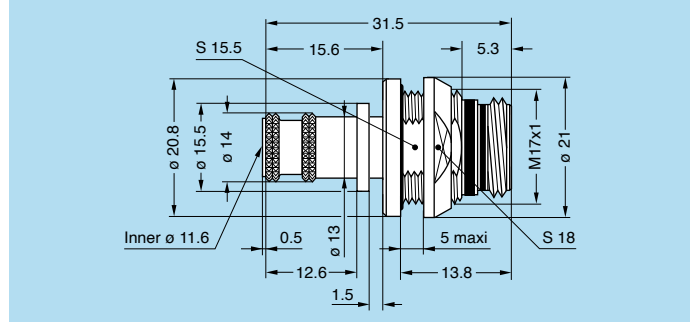

PF●.2M.514 Fixed socket with square flange, key (N) or keys (P and U) with mold stop

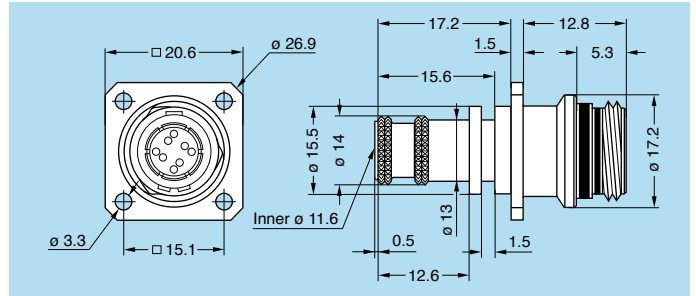

PM●.2M.514 Free socket, key (N) or keys (P and U) with knurled grip and mold stop

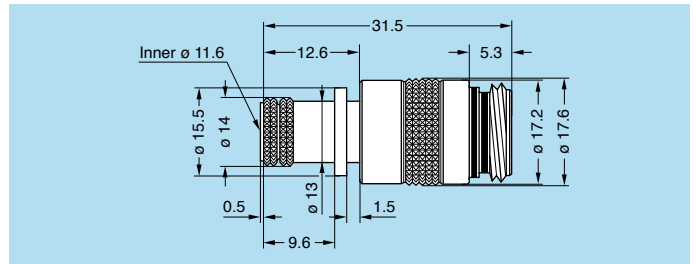

PH●.2M.514 Free socket, key (N) or keys (P and U) with arctic grip and mold stop

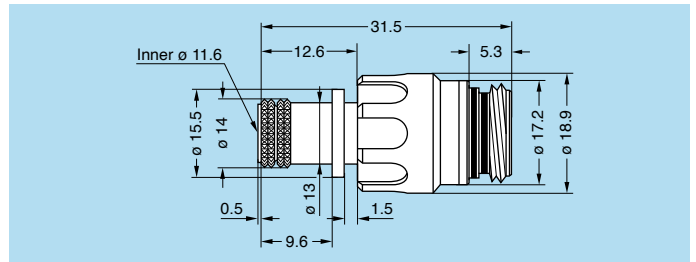

HE●.2M.514 Fixed socket, nut fixing, key (N) or keys (P and U), printed circuit, watertight, (back panel mounting)

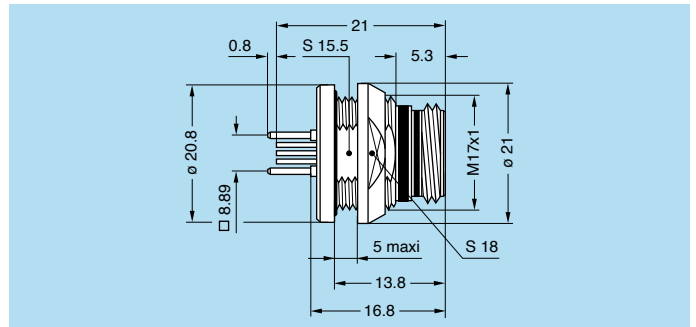

Note: see page 41 for panel cut-out and page 42 for PCB drilling pattern. For HE● environmental performance see page 14.



LMU2A

USB 2.0 models

Those configurations meet the USB 2.0 (480 Mb/s) data transfer requirements using USB Type A inserts.

FM●LM.U2A.XPAT Straight plug, key (W) or keys (R and H) with knurled grip and mold stop

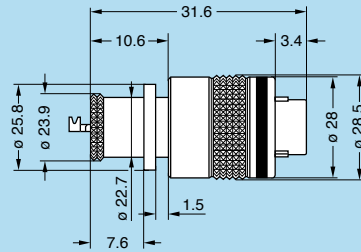

FG●LM.U2A.XPAT Straight plug, key (W) or keys (R and H) with arctic grip and mold stop

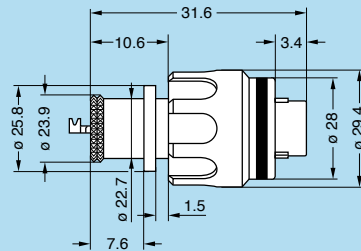

EG●LM.U2A.XPP Fixed socket, female to female, nut fixing, key (W) or keys (R and H)

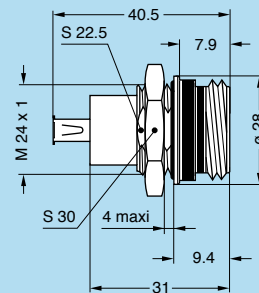

EG●LM.U2A.XPL Fixed socket, nut fixing, key (W) or keys (R and H)

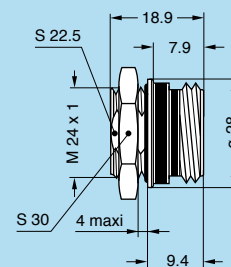

Note: see page 41 for panel cut-out.



Fibre Optic models

F●● Straight plug (contact to be ordered separately, see page 31)

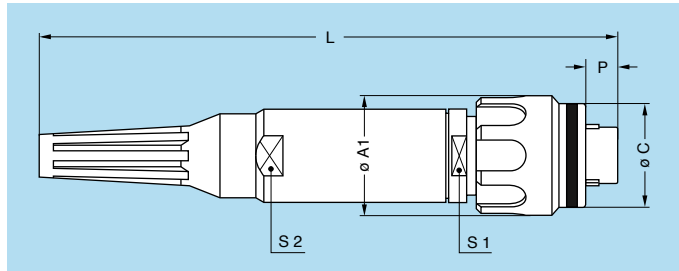
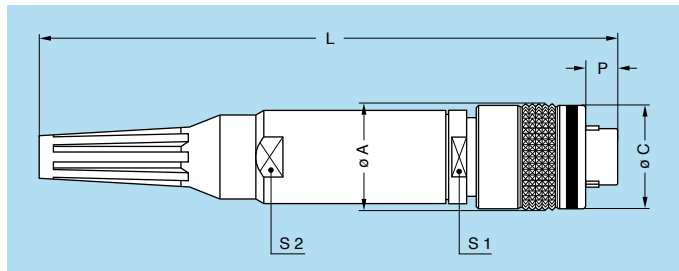

Part number	Dimensions (mm)						
	A	A1	C	L	P	S1	S2
F●S.2M.03A.XLZT●●Z	17.6	18.9	17.2	100.6	3.9	14.0	14.0
F●N.3M.95B.XLCT●●Z	19.6	20.9	19.2	103.3	3.9	16.0	16.0
F●W.5M.03W.XLZT●●Z	34.0	34.9	33.5	148.4	3.4	29.0	29.0

Note: ●● cable adaptor diameter defined upon request. The bend relief must be ordered separately (see page 37).

P●● Free socket (contact to be ordered separately, see page 31)

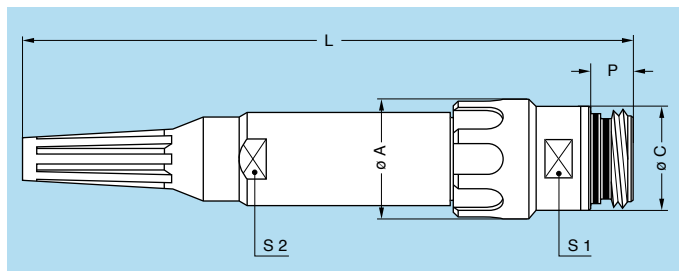
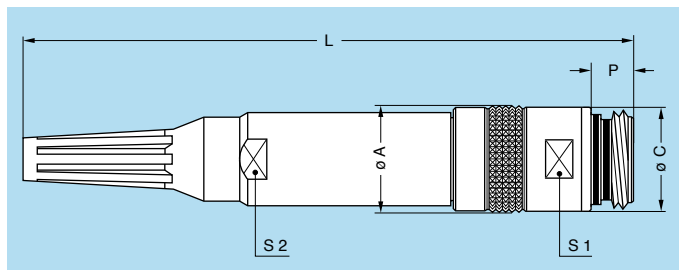

Part number	Dimensions (mm)						
	A	A1	C	L	P	S1	S2
P●S.2M.03A.XLZT●●Z	17.6	18.9	17.2	105.8	5.3	16.0	14.0
P●N.3M.95B.XLMT●●Z	19.6	20.9	19.2	113.3	5.3	18.0	16.0
P●W.5M.03W.XLZT●●Z	34.0	34.9	33.5	155.2	7.9	32.0	29.0

Note: ●● cable adaptor diameter defined upon request. The bend relief must be ordered separately (see page 37).



EG● Fixed socket, nut fixing (contact to be ordered separately, see page 31)

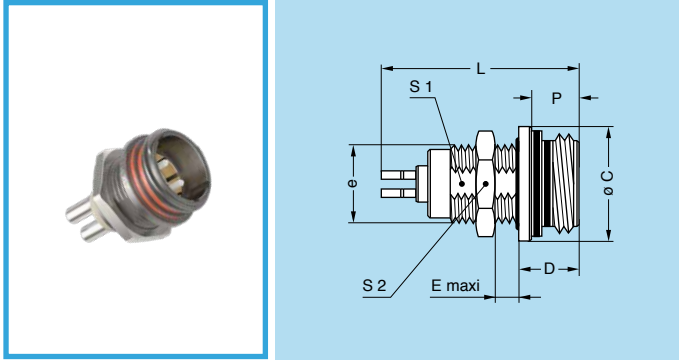

Part number	Dimensions (mm)							
	C	D	e	E	L	P	S1	S2
EGS.2M.03A.XLZ	17.2	6.8	M14x1.0	4.5	28.9	5.3	12.5	17.0
EGN.3M.95B.XLM	19.2	6.8	M16x1.0	4.0	32.2	5.3	14.5	19.0
EGW.5M.03W.XLZ	33.5	9.4	M30x1.0	4.0	30.8	7.9	28.5	36.0

Panel cut-out (page 41).

ED● Fixed socket with square flange (contact to be ordered separately, see page 31)

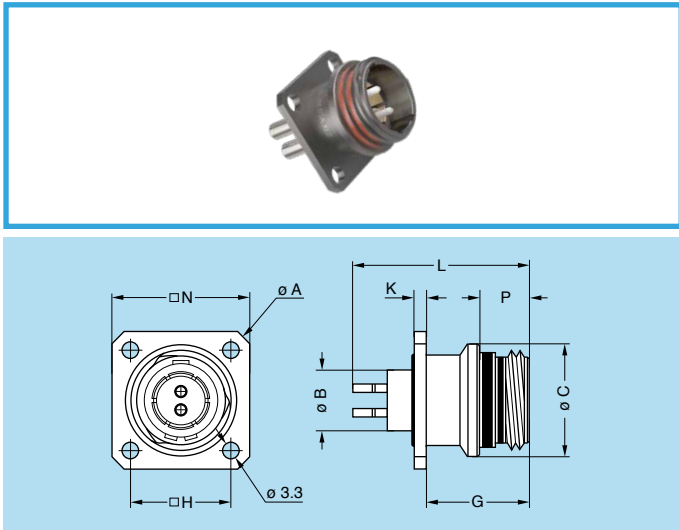

Part number	Dimensions (mm)								
	A	B	C	G	H	K	L	N	P
EDS.2M.03A.XLZ	26.9	8.95	17.2	12.8	15.1	1.5	28.9	20.6	5.3
EDN.3M.95B.XLM	29.0	10.95	19.2	12.8	16.6	1.5	32.2	22.1	5.3
EDW.5M.03W.XLZ	43.7	22.90	33.5	14.5	27.0	2.0	30.8	32.5	7.9

Panel cut-out (page 41).

High Power models

Part numbering system

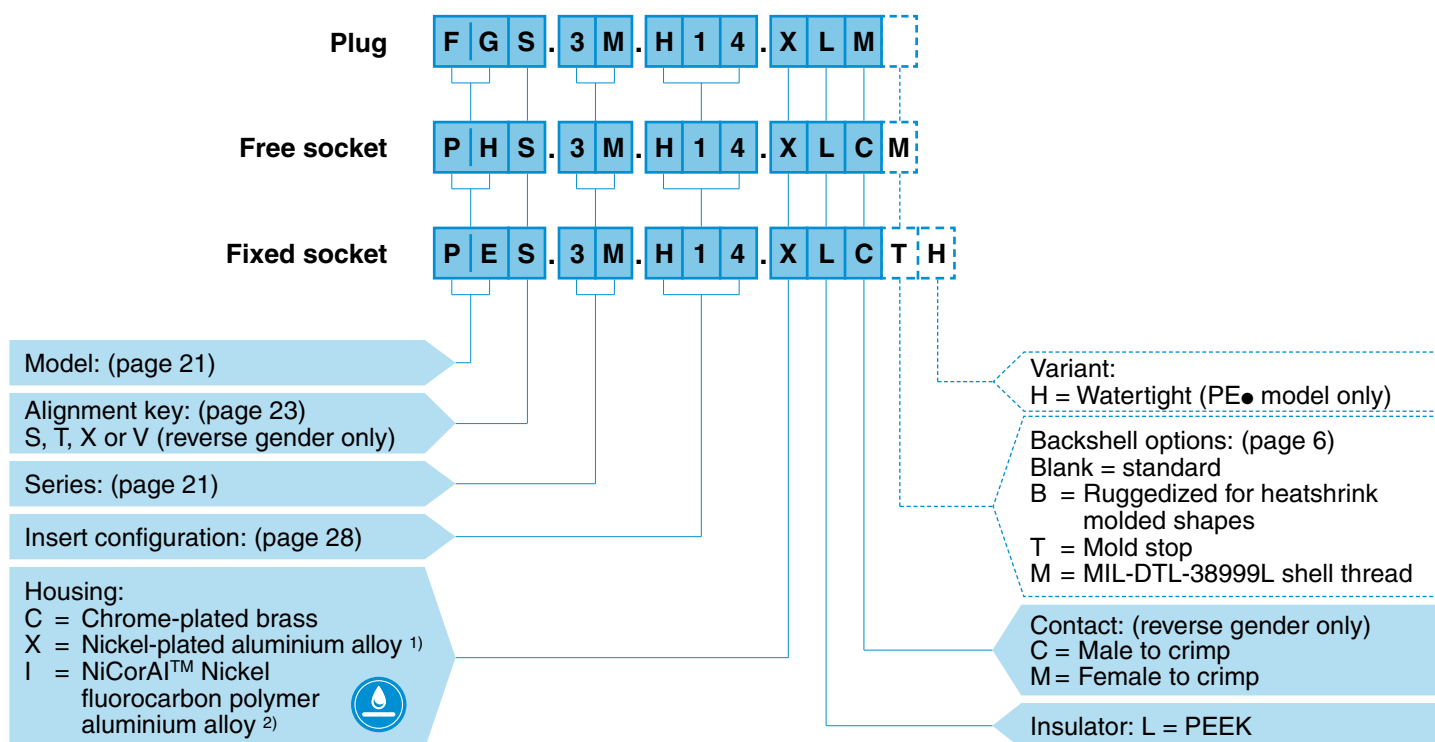

FGS.3M.H14.XLM = straight plug with key (S), knurled grip, 3M series, high power contacts, outer shell in anthracite nickel-plated aluminium alloy, PEEK insulator, female crimp contacts.

PHS.3M.H14.XLCM = free socket with key (S), knurled grip, 3M series, high power contacts, outer shell in anthracite nickel-plated aluminium alloy, PEEK insulator, male crimp contacts, MIL-DTL-38999L shell thread.

PES.3M.H14.XLCTH = fixed socket with key (S), 3M series, high power contacts, outer shell in anthracite nickel-plated aluminium alloy, PEEK insulator, male crimp contacts, mold stop, watertight.

Note: ¹⁾ anthracite colour / 48 hours salt fog resistance. ²⁾ anthracite colour / 500 hours salt fog resistance RoHS 2/REACH.

FM●/FG● Straight plug

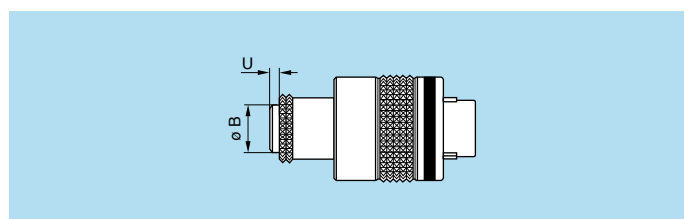

Reference	ø B (mm)	Dimensions U (mm)		
		Backshell options		
		Standard	Code B/T	Code M
3M.H14	11.0	5.5	2.5	3.6
TM.H15	12.3	5.5	2.5	4.1
4M.H16	14.0	5.5	2.5	4.1
LM.H18	18.0	10.0	7.0	8.6
5M.H18	22.9	10.0	7.0	8.6
5M.H34/G33	22.9	–	–	–

Note: all others dimensions can be found on standard models (page 7).

FX●/FW●/FA● Straight plug with square flange

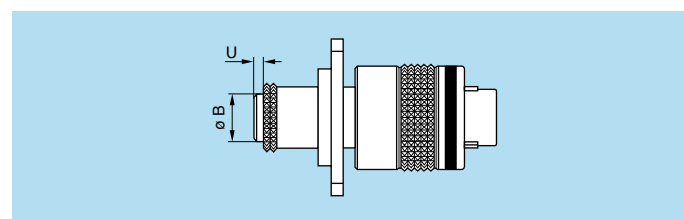

Reference	ø B (mm)	Dimensions U (mm)		
		Backshell options		
		Standard	Code B/T	Code M
3M.H14	11.0	0.5	–	–
TM.H15	12.3	–	–	–
4M.H16	14.0	–	–	–
LM.H18	18.0	3.8	0.8	2.4
5M.H18	22.9	3.8	0.8	2.4
5M.H34/G33	22.9	–	–	–

Note: all others dimensions can be found on standard models (page 8).

EG●/EC● Fixed socket

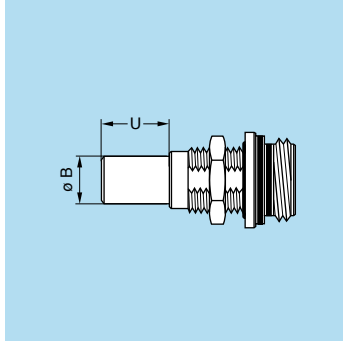

Reference	Dim. (mm)	
	ø B	U
3M.H14	11.0	11.7
TM.H15	12.3	13.1
4M.H16	14.0	13.1
LM.H18	18.0	17.6
5M.H18	22.9	17.6
5M.H34/G33	22.9	10.6

Note: all others dimensions can be found on standard models (page 9).

ED● Fixed socket

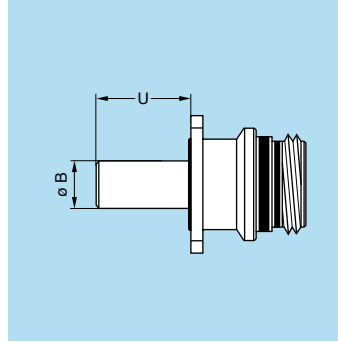

Reference	Dim. (mm)	
	ø B	U
3M.H14	11.0	14.2
TM.H15	12.3	15.5
4M.H16	14.0	15.5
LM.H18	18.0	20.0
5M.H18	22.9	20.0
5M.H34/G33	22.9	13.0

Note: all others dimensions can be found on standard models (page 10).

PE●/PF● Fixed socket

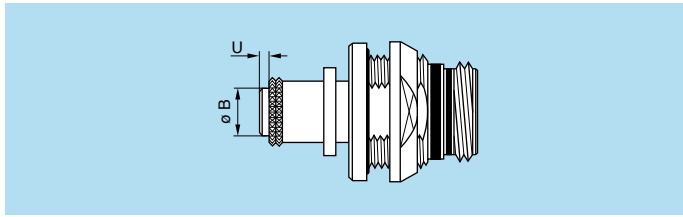

Reference	ø B (mm)	Dimensions U (mm)	
		Backshell options	
		Code B/T	Code M
3M.H14	11.0	2.5	2.1
TM.H15	12.3	1.9	1.9
4M.H16	14.0	1.9	1.9
LM.H18	18.0	6.4	6.4
5M.H18	22.9	6.4	6.4
5M.H34/G33	22.9	–	–

Note: all others dimensions can be found on standard models (p. 10, 11).

PM●/PH● Free socket

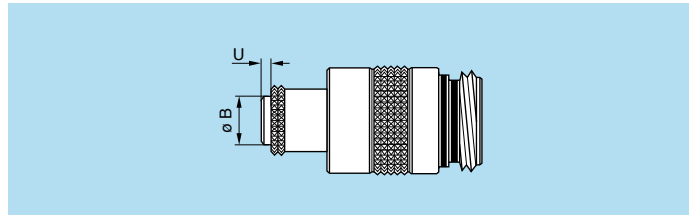

Reference	ø B (mm)	Dimensions U (mm)		
		Backshell options		
		Standard	Code B/T	Code M
3M.H14	11.0	2.5	–	0.6
TM.H15	12.3	1.9	0.8	1.9
4M.H16	14.0	1.9	0.8	1.9
LM.H18	18.0	6.4	5.3	6.4
5M.H18	22.9	6.4	5.3	6.4
5M.H34/G33	22.9	–	–	–

Note: all others dimensions can be found on standard models (p. 12).

PB●/PV●/PT● Fixed socket with antivibration flange

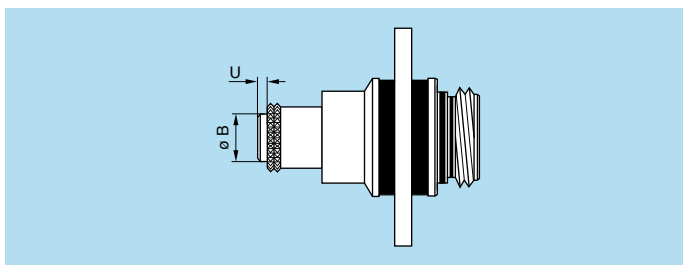

Reference	ø B (mm)	Dimensions U (mm)		
		Backshell options		
		Standard	Code B/T	Code M
3M.H14	11.0	2.5	–	1.0
TM.H15	12.3	1.9	0.8	1.9
4M.H16	14.0	1.9	0.8	1.9
LM.H18	18.0	6.4	5.3	6.4
5M.H18	22.9	6.4	5.3	6.4
5M.H34/G33	22.9	–	–	–

Note: all others dimensions can be found on standard models (p. 13).

Alignment key

Alignment key and Polarized keying system

M series connector model part numbers are composed of three letters. The LAST LETTER indicates the keys corresponding to a particular contact type.

For example, straight plugs with H, N, P, R, U or W keys, are fitted with male contacts; whereas with S, T, V or X keys, plugs are fitted with female contacts. Sockets with H, N, P, R, U or W keys, are fitted with female contacts; whereas with S, T, V or X keys, sockets are fitted with male contacts.

MM to 3M	Front view of a socket 	Model	Colour code	Gender	Contact type		Nb of keys	Angles	
					Plug	Socket		β	γ
		●●N	blue	standard	male	female	3	165°	30°
●●P	yellow	150°	60°						
●●U	green	130°	100°						
●●S	red	reverse	female	male	3	155°	50°		
●●T	orange					135°	90°		

TM to 5M	Front view of a socket 	Model	Colour code	Gender	Contact type		Nb of keys	Angles			
					Plug	Socket		α	β	γ	δ
		●●W	blue	standard	male	female	5	95°	115°	35°	25°
●●R	yellow	105°	115°					30°	20°		
●●H	green	120°	95°					25°	45°		
●●X	red	reverse	female	male	5	100°	125°	40°	20°		
●●V	orange					110°	120°	35°	25°		

Colour coding

M Series connector attributes a colour code for each alignment key thus allowing for easy identification of matching plugs and sockets within the system.

- Standard plated versions only have a light colour ring on the plug nut and socket for identification.
- Anodized aluminium version are proposed with the complete body matching the corresponding colour code/key.



Standard nickel-plated aluminium version



Anodized aluminium version

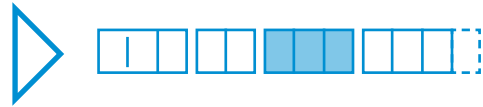





Insert configuration

Multipole

	Male insert		Female insert		Reference	Number of contacts	ø A (mm)	Contact type		AWG	Test voltage (kV rms) ¹⁾ Contact-contact	Test voltage (kV rms) ¹⁾ Contact-shell	Rated current (A) ²⁾
			Crimp	Print (straight) ³⁾									
MM			●	●	303	3	0.5	●	●	28-30-32	1.15	0.95	3.0
			●	●	304	4	0.5	●	●	28-30-32	0.95	0.90	2.0
OM			●	●	302	2	0.9	●	●	20-22-24	1.45	1.00	10.0
			●	●	303	3	0.9	●	●	20-22-24	1.70	1.40	8.0
			●	●	304	4	0.7	●	●	22-24-26	1.35	0.90	7.0
			●	●	305	5	0.7	●	●	22-24-26	1.25	1.00	6.5
1M			●	●	302	2	1.3	●	●	16-18-20	1.55	1.10	19.0
			●	●	303	3	1.3	●	●	16-18-20	1.05	0.95	15.5
			●	●	305	5	0.9	●	●	20-22-24	1.30	1.30	9.0
			●	●	307	7	0.7	●	●	22-24-26	1.45	1.20	7.0
			●	●	308	8	0.7	●	●	22-24-26	1.30	1.10	5.0
2M			●	●	304	4	1.3	●	●	16-18-20	1.55	1.35	15.5
			●	●	308	8	0.9	●	●	20-22-24	1.95	1.10	10.0
			●	●	310	10	0.9	●	●	20-22-24	1.80	1.20	8.0
			●	●	312	12	0.7	●	●	22-24-26	1.65	1.15	7.0
			●	●	316	16	0.7	●	●	22-24-26	1.20	1.00	4.5
			●	●	319	19	0.7	●	●	22-24-26	1.20	1.00	4.0
3M			●	●	312	12	0.9	●	●	20-22-24	1.40	1.25	6.0
			●	●	322	22	0.7	●	●	22-24-26	1.25	1.15	4.0
			●	●	330	30	0.7	●	●	22-24-26	1.10	1.00	3.5

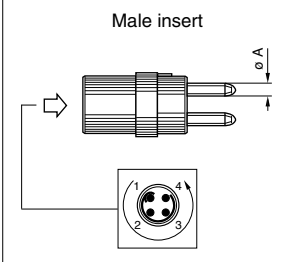
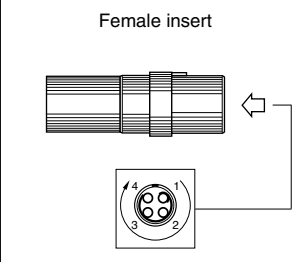
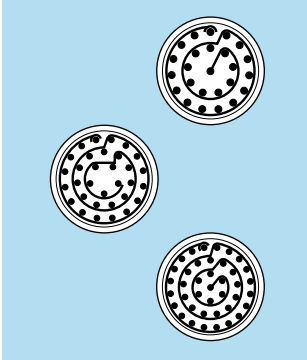
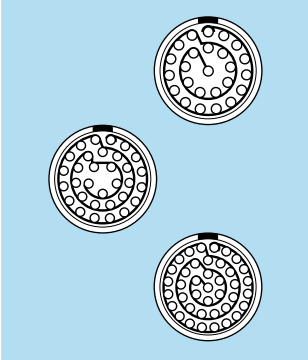

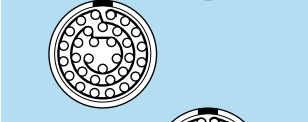

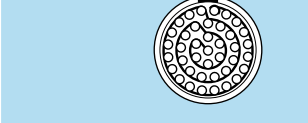
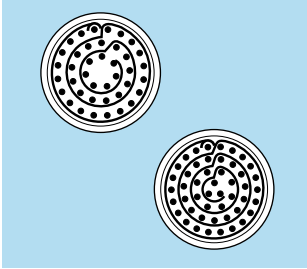
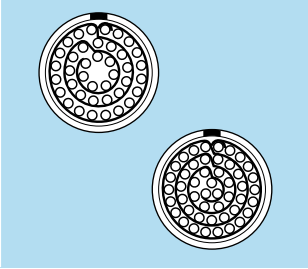
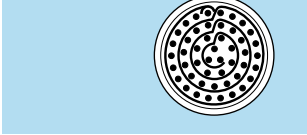
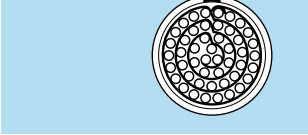
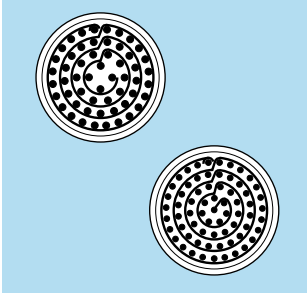
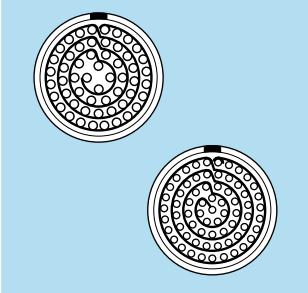
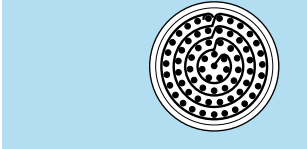
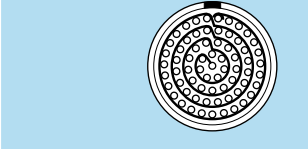
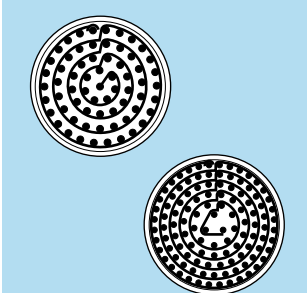
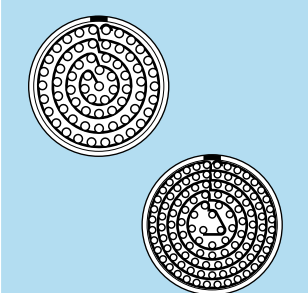
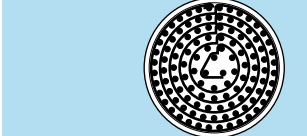
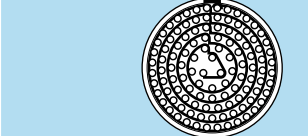

Multipole

	Male insert 	Female insert 	Reference	Number of contacts	ø A (mm)	Contact type		AWG	Test voltage (kV rms) ¹⁾ Contact-contact	Test voltage (kV rms) ¹⁾ Contact-shell	Rated current (A) ²⁾
						Crimp	Print (straight) ³⁾				
TM			325	25	0.9	●	●	20-22-24	1.10	1.25	5.0
			332	32	0.7	●	●	22-24-26	1.25	1.20	3.5
			340	40	0.7	●	●	22-24-26	1.05	1.20	3.0
4M			340	40	0.7	●	●	22-24-26	1.20	1.35	3.5
			348	48	0.7	●	●	22-24-26	1.10	1.35	3.0
LM			355	55	0.9	●	●	20-22-24	1.65	1.95	3.5
			368	68	0.7	●	●	22-24-26	1.40	1.65	2.5
5M			366	66	0.9	●	●	20-22-24	1.60	1.70	3.0
			114	114	0.7	●	●	22-24-26	1.37	1.34	2.0

Note:

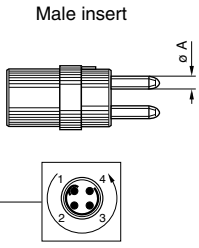
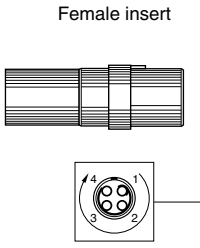
- 1) test voltage according to IEC 60512-2 test 4a. Altitude correction factor is given in IEC 60664-1 table A.2.
- 2) the specified rated current can be applied simultaneously to all the contacts. It corresponds to an average temperature rise of 40°C of the connector (measured according to IEC 60512-3 test 5a).
- 3) for EG•, EC•, ED•, HE•, HY• socket.

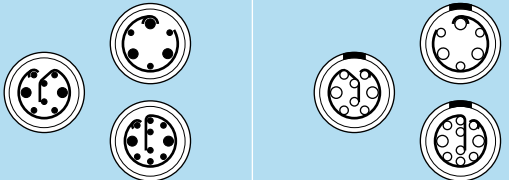

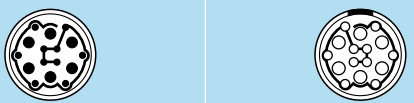
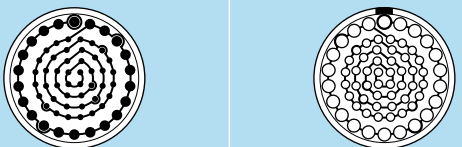
Mixed multipole

	 		Reference	Number of contacts	ø A (mm)	Contact type		AWG	Test voltage (kV rms) ¹⁾ Contact-contact	Test voltage (kV rms) ¹⁾ Contact-shell	Rated current (A) ²⁾
	Crimp	Print (straight) ³⁾									
1M			304	2	0.7	●	●	22-24-26	1.20	1.30	11.0
				2	1.3	●	●	16-18-20	1.45	2.00	18.5
2M			306	3	0.7	●	●	22-24-26	1.55	1.40	10.5
				3	1.3	●	●	16-18-20	2.05	1.35	18.0
				308	6	0.7	●	●	22-24-26	1.95	1.40
2	1.3	●	●		16-18-20	1.75	1.60	23.0			
310			310	8	0.7	●	●	22-24-26	1.35	1.35	6.0
				2	1.3	●	●	16-18-20	1.90	1.15	23.0
3M			316	10	0.7	●	●	22-24-26	0.90	0.95	2.0
				6	1.3	●	●	16-18-20	1.35	1.15	11.0
5M			366	44	0.7	●	●	22-24-26	1.65	2.70	3.0
				22	1.3 ⁴⁾	●	●		1.95	1.80	6.0

Note:

- ¹⁾ test voltage according to IEC 60512-2 test 4a. Altitude correction factor is given in IEC 60664-1 table A.2.
- ²⁾ the specified rated current can be applied simultaneously to all the contacts. It corresponds to an average temperature rise of 40°C of the connector (measured according to IEC 60512-3 test 5a).
- ³⁾ for EG•, EC•, ED•, HE•, HY• socket.
- ⁴⁾ reduced crimp barrel.

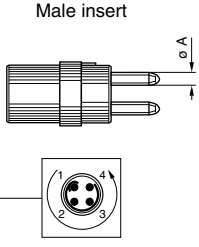
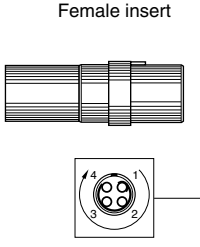
Multipole high speed ethernet cat6

	 		Reference	Number of contacts	ø A (mm)	Crimp contact	Test voltage (kV rms) ¹⁾ Contact-contact	Test voltage (kV rms) ¹⁾ Contact-shell	Rated current (A) ²⁾
2M			514	8	0.7	●	1.5	1.5	8

Note:

- ¹⁾ test voltage according to IEC 60512-2 test 4a. Altitude correction factor is given in IEC 60664-1 table A.2.
- ²⁾ the specified rated current can be applied simultaneously to all the contacts. It corresponds to an average temperature rise of 40°C of the connector (measured according to IEC 60512-3 test 5a).



USB 2.0

	Male insert front view	Female insert front view	Reference	Number of contacts	Solder contact	Test voltage (kV rms) ¹⁾ Contact-contact	Test voltage (kV rms) ¹⁾ Contact-shell	Rated current (A) ²⁾
LM			U2A	4	●	1.20	0.95	n.a.

Note: ¹⁾ and ²⁾ see page 26. See models on page 18.

Multi fibre and Mixed fibre optic + low voltage

	Male insert	Female insert	Reference	Number of F7 FO contacts	Low voltage contact					
					Number of contacts	ø A (mm)	Crimp contact type	Crimp contact		Rated current (A) ²⁾
							Crimp	Test voltage (kV rms) ¹⁾ Contact-contact	Test voltage (kV rms) ¹⁾ Contact-shell	
2M			03A	2	-	-	-	-	-	-
3M			95B	4	4	0.9	●	1.00	0.80	8.0
5M			03W	21	-	-	-	-	-	-

Note: ¹⁾ and ²⁾ see page 26. Contacts must be ordered separately (see page 31).

Mixed high speed coax

	Male insert	Female insert	Reference	Contact type C	Low voltage contact						
					Number of contacts	ø A (mm)	Crimp contact	AWG	Test voltage (kV rms) ¹⁾ Contact-contact	Test voltage (kV rms) ¹⁾ Contact-shell	Rated current (A) ²⁾
2M			X04	1	2 2	0.9 1.3	●	22-24-26 16-18-20	0.75	1.05	10 7

Note: ¹⁾ and ²⁾ see page 26. Contacts must be ordered separately (see pages 30 and 31).

High Power

	Male insert	Female insert	Reference	Number of contacts	Contact ø (mm)	Crimp contact	Wire section (mm ²)	Crimp (max.) (AWG)	Test voltage (kV rms) ¹⁾ Contact-contact	Test voltage (kV rms) ¹⁾ Contact-shell	Max. rated current (A) at 25°C ambient temperature ²⁾	Rated current (A) ³⁾
3M			H14	1	4.0	●	10	8	–	4.7	160	78
TM			H15	1	5.0	●	16	6	–	4.5	205	106
4M			H16	1	6.0	●	25	4	–	4.4	270	138
LM			H18	1	8.0	●	35	2	–	4.7	340	183
5M	 	 	H18	1	8.0	●	50	1	–	4.0	430	228
			H34	3	4.0	●	10	8	9.0	4.7	140 ⁴⁾	52
			G33	3 (HP) 3 (LV)	4.0 0.9 ⁵⁾	● ●	10 6)	8 20-24	9.0 1.5	4.7 1.5	140 ⁴⁾ –	52 3

Warning: According to application safety standard, the maximum operating voltage must be determined considering both connector and cable electrical characteristics.

Note:

- ¹⁾ test voltage according to IEC 60512-2 test 4a; test voltage for connector only. Altitude correction factor is given in IEC 60664-1 table A.2.
- ²⁾ see derating curves for more information.
- ³⁾ the specified rated current can be applied simultaneously to all the contacts. It corresponds to an average temperature rise of 40°C of the connector (measured according to IEC 60512-3 test 5a).
- ⁴⁾ rated current per contact (on all contact) simultaneously.
- ⁵⁾ sequential connection: first mate/last break High Power contacts.
- ⁶⁾ see LV contacts dimensions on page 30.

Both plugs and sockets provide IP2X finger protection to comply with the IEC61032 standard.

Derating curves

The derating curve is a current-carrying capacity curve showing which currents may flow continuously via the connector subject to various ambient temperatures. It includes a safety factor (0.8) to protect from spikes and factor uncertainties in temperature measurement.

For example, ambient temperature for connectors on e-Formula 1 batteries is around 50°C. At that temperature, the current that can go through a 10 mm² cable is 120A; it is 130A at 25°C and goes down to 95A at 100°C (see chart on the side).

It's therefore important to always clarify the ambient operating temperature & required current to select the right high-power connector. Note that the limiting factor is often the cable and not the connector, so special attention is required in selecting the cable too.

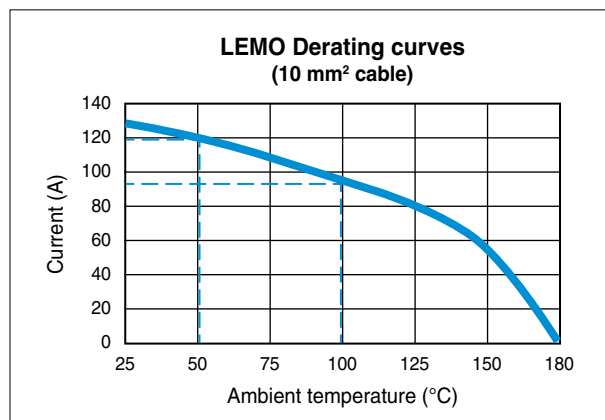

The chart below was built based on the maximum derated current until a temperature rise of 180°C was reached. It is intended as a guide only, when used with the stated cable sizes on the plug and socket. It's the designer's responsibility to consider all physical and environmental factors which may affect de-rating. Please feel free to contact your LEMO representative to assist in selecting appropriate connector solutions.

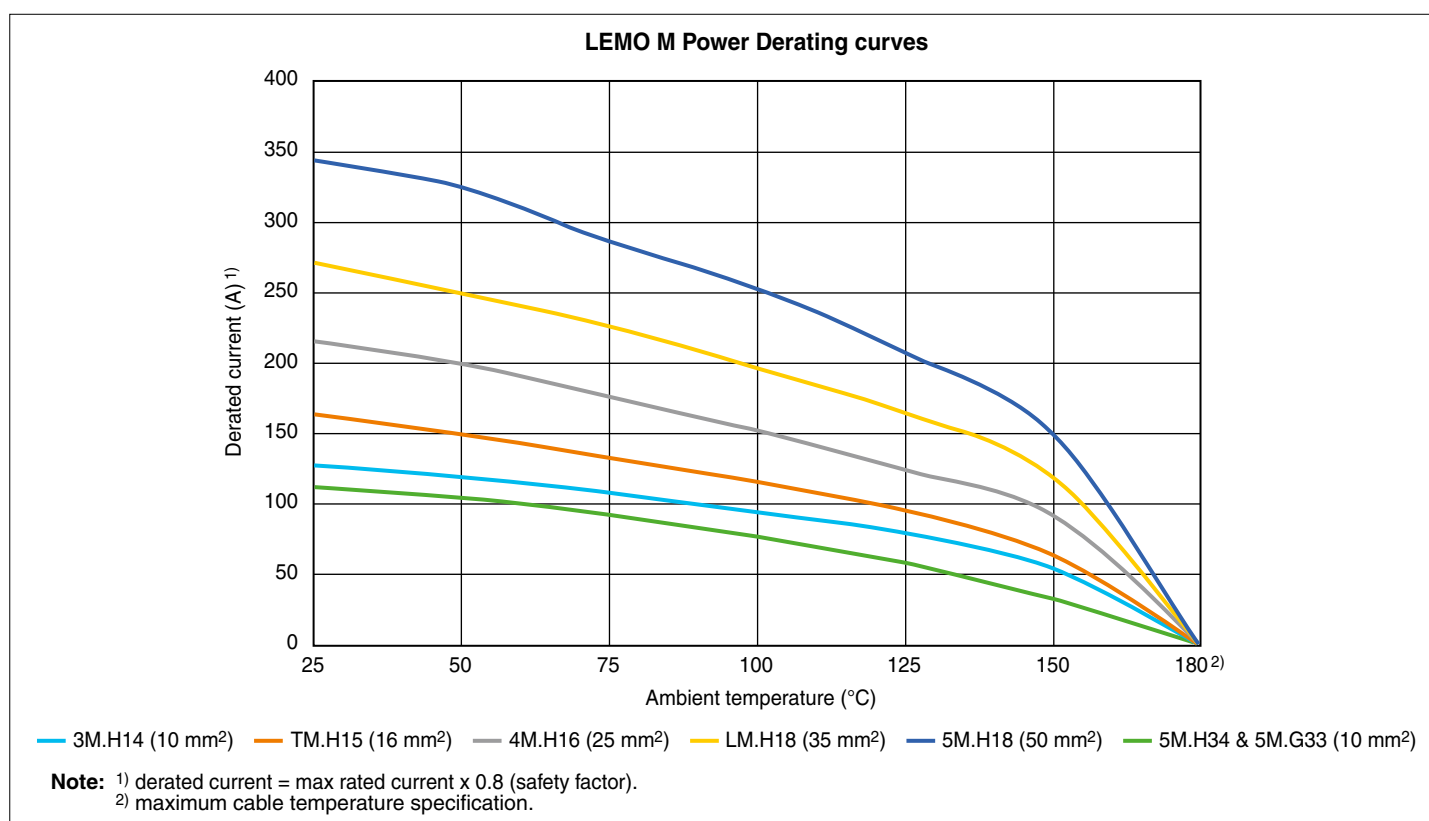

Recommended cables

Brand	Reference	Wire section		Max temp.	Colour	Outer ø (mm)	Shielded	Operating voltage
		mm ²	AWG					
COROPLAST	9-2611/10	10	8	180°C	RAL 2003	8.8	Yes	600 VAC / 1000 VDC
COROPLAST	9-2611/16	16	6	180°C	RAL 2003	10.2	Yes	600 VAC / 1000 VDC
COROPLAST	9-2611/25	25	4	180°C	RAL 2003	12.2	Yes	600 VAC / 1000 VDC
COROPLAST	9-2611/35	35	2	180°C	RAL 2003	14.4	Yes	600 VAC / 1000 VDC
COROPLAST	9-2611/50	50	1	180°C	RAL 2003	15.8	Yes	600 VAC / 1000 VDC

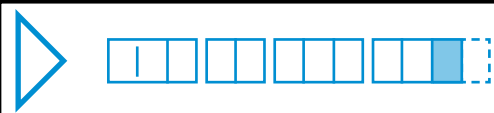

Contacts

Spare parts contacts can be ordered separately using references listed in this chapter.
All connectors are delivered with their contacts except for coaxial, high voltage, fibre optic contacts.

Reference	Contact type
C	Male crimp with standard crimp barrel (fig. 1)
B	Male crimp with reduced crimp barrel (fig. 2)
D	Male straight print
H	Male / Female straight print (for HY model only)

Reference	Contact type
M	Female crimp with standard crimp barrel (fig. 1)
P	Female crimp with reduced crimp barrel (fig. 2)
N	Female straight print

Crimp contacts for plugs, free or fixed sockets

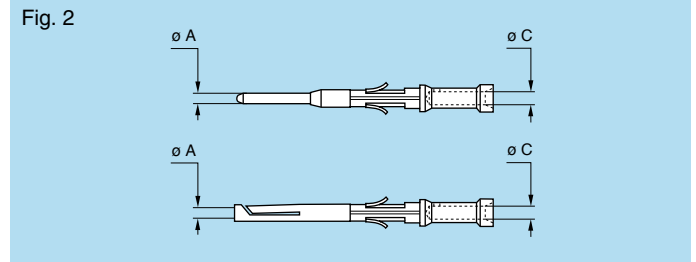
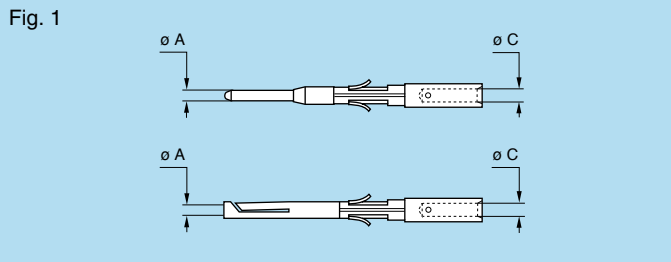

Note: in order to satisfy crimp pull-test requirements to the IEC 60352-2 standard, the use of single strand cables should be avoided.

Dimension of crimp barrels

	Contact			Ref. contact type		Conductor				Part number	
	ø A (mm)	ø C (mm)	Form per fig.	Male	Female	AWG		Section (mm ²)		For male contacts	For female contacts
						min.	max.	min.	max.		
MM	0.5	0.42	1	C	M	32	28	0.035	0.090	FGG.00.554.ZZC	EGG.00.654.ZZM
0M to 3M	1.3	1.60	1	C	M	20	16	0.616	1.433	FGN.0M.565.ZZC	EGN.0M.665.ZZM
	0.9	1.10	1	C	M	24	20	0.204	0.616	FGN.0M.560.ZZC	EGN.0M.660.ZZM
	0.9	0.87	2	B	P	26	22	0.128	0.382	FGN.0M.561.ZZC	EGN.0M.661.ZZM
	0.7	0.87	1	C	M	26	22	0.128	0.382	FGN.0M.555.ZZC	EGN.0M.655.ZZM
	0.7	0.44	2	B	P	32	28	0.032	0.092	FGN.0M.556.ZZC	EGN.0M.656.ZZM
TM to 5M	1.3	1.60	1	C	M	20	16	0.616	1.433	FGN.0M.565.ZZC	EGN.0M.665.ZZM
	0.9	1.10	1	C	M	24	20	0.204	0.616	FGN.0M.560.ZZC¹⁾	EGW.TM.660.ZZM
	0.9	0.87	2	B	P	26	22	0.128	0.382	FGN.0M.561.ZZC	EGW.TM.661.ZZM
	0.7	0.87	1	C	M	26	22	0.128	0.382	FGN.0M.555.ZZC	EGW.TM.655.ZZM
	0.7	0.44	2	B	P	32	28	0.032	0.092	FGN.0M.556.ZZC	EGW.TM.656.ZZM

Note: ¹⁾ the low voltage male contact part number for the High Power configuration 5M.G33 is FGN.0M.560.ZZCY. For female contact the part number is EGW.TM.660.ZZM.

Dimension of crimp barrels High Speed ethernet cat6

	Contact			Ref. contact type		Conductor				Part number	
	ø A (mm)	ø C (mm)	Form per fig.	Male	Female	AWG		Section (mm ²)		For male contacts	For female contacts
						min.	max.	min.	max.		
2M	0.7	0.87	1	C	M	26	22	0.128	0.382	FGN.2M.558.ZZC	EGN.2M.658.ZZM

Coaxial and High Voltage contacts (must be ordered separately)

Contact	Part number	
	For male contacts	For female contacts
Coaxial (75 Ohms, 3 GHz) ¹⁾	FFS.2B.275.ZTCE31	PSS.2B.275.ZTME31
Coaxial (50 Ohms) ²⁾	FFS.2B.250.ZTCE30	PSS.2B.250.ZTME30
High Voltage	FFS.2B.401.ZLCE_	PSS.2B.401.ZLME_

Note:

¹⁾ recommended cable Belden 179DT to reach 6GHz.

For more information, please consult: https://www.lemo.com/catalog/ROW/UK_English/3GHz_75_ohms_connector_for_4k_8k_HDTV.pdf

²⁾ cable group 1, or other... see more details in coax-triax-mixed catalogue.

Dimension of crimp barrels High Power

Series	Contact ø (mm)	Ref. contact type		Wire section		Part number	
		Male	Female	mm ²	AWG	For male contacts	For female contacts
3M/5M ¹⁾	4.0	C	M	10	8	FGG.3M.P04.ZZC	EGG.3M.P04.ZZM
TM	5.0	C	M	16	6	FGG.TM.P05.ZZC	EGG.TM.P05.ZZM
4M	6.0	C	M	25	4	FGG.4M.P06.ZZC	EGG.4M.P06.ZZM
LM	8.0	C	M	35	2	FGG.LM.P08.ZZC	EGG.LM.P08.ZZM
5M	8.0	C	M	50	1	FGG.5M.P08.ZZC	EGG.5M.P08.ZZM

Note: ¹⁾ for 5M.H34 and 5M.G33 configurations.



F7 Fibre Optic contacts

The choice of the ferrule hole diameter is dependent upon the fibre cladding size. LEMO offers a range of ferrule hole diameters to suit the users' specific requirements.

Series	Contact part number	
	For straight plug	For free or fixed socket
2M	PSS.F7.●●●.LCE23	FFS.F7.●●●.LCE23
3M	FFS.F7.●●●.LCE23	PSS.F7.●●●.LCL23
5M	FFS.F7.●●●.LCE23	PSS.F7.●●●.LCE23

Reference	ø Core/Cladding (µm)	Ferrule hole diameter (µm)	Note
125	9/125 (singlemode)	125	●
126	50/125 62.5/125 (multimode)	126	●
128		128	○

Note: the «●●●» indicates the reference of the ferrule hole diameter.

● First choice alternative ○ Special order alternative

FFS.F7 Male F7 Fibre Optic contact

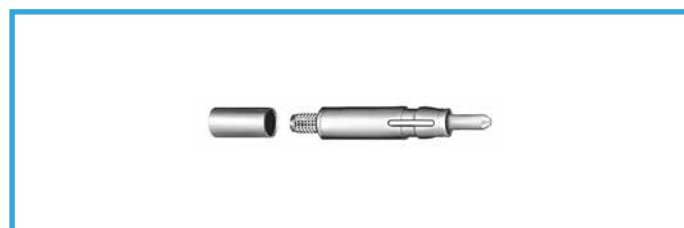

PSS.F7 Female F7 Fibre Optic contact

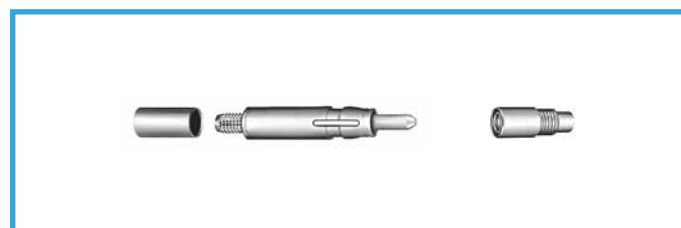

Accessories

Blanking caps IP68 ratchet secured (watertight)

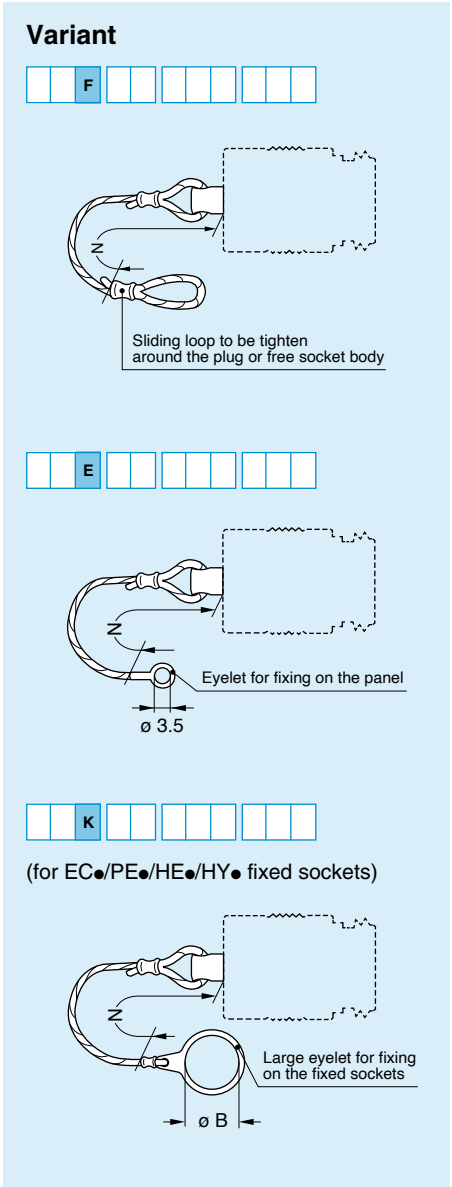
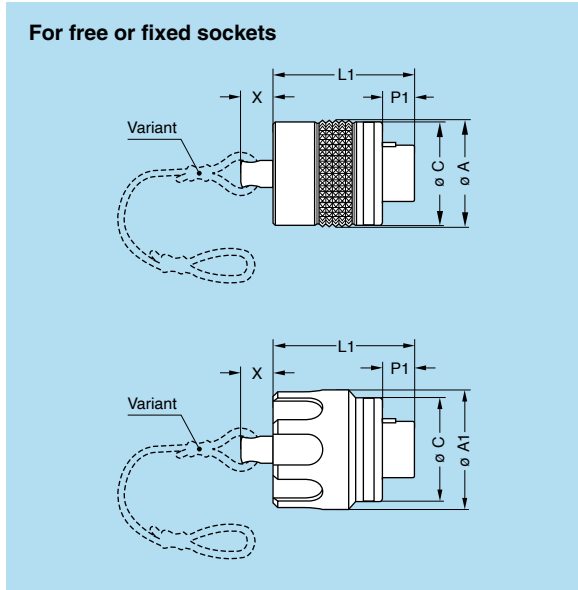
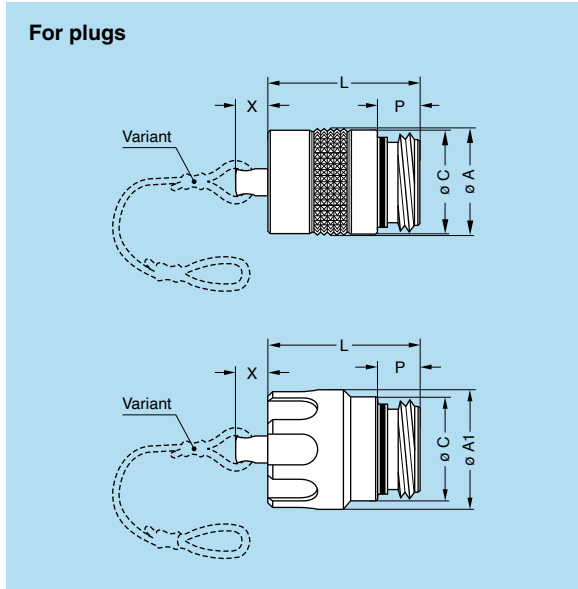
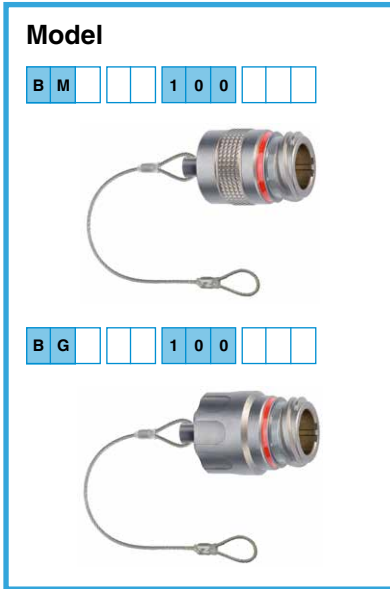

Part number for plugs	Dimensions (mm)								Dim. (mm)		Part number for free or fixed sockets
	A	A1	C	L	L1	P	P1	X	B	N ¹⁾	
B●.MM.100.●AV	11.1	12.0	10.7	13.8	15.5	3.7	5.5	4.0	10.1	60	B●.MM.200.●AZ
B●.0M.100.●AV	13.1	14.4	12.7	18.6	17.4	5.3	3.9	6.0	13.1	85	B●.0M.200.●AZ
B●.1M.100.●AV	14.6	15.9	14.2	18.6	17.4	5.3	3.9	6.0	14.1	85	B●.1M.200.●AZ
B●.2M.100.●AV	17.6	18.9	17.2	18.6	17.4	5.3	3.9	6.0	17.2	85	B●.2M.200.●AZ
B●.3M.100.●AV	19.6	20.9	19.2	18.6	17.4	5.3	3.9	6.0	19.2	120	B●.3M.200.●AZ
B●.TM.100.●AV	22.5	23.4	22.0	21.1	21.0	7.9	3.4	10.0	22.2	120	B●.TM.200.●AZ
B●.4M.100.●AV	25.0	25.9	24.5	21.1	21.0	7.9	3.4	10.0	24.2	120	B●.4M.200.●AZ
B●.LM.100.●AV	28.5	29.4	28.0	21.1	21.0	7.9	3.4	10.0	28.2	150	B●.LM.200.●AZ
B●.5M.100.●AV	34.0	34.9	33.5	21.1	21.0	7.9	3.4	10.0	33.2	150	B●.5M.200.●AZ

Note: ¹⁾ the tolerance on this dimension is ± 5 mm.

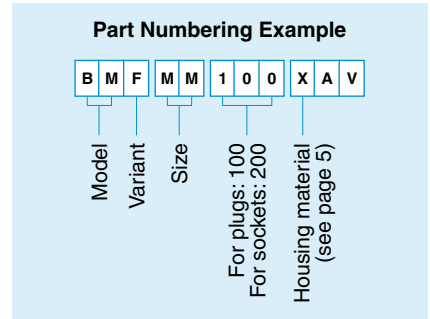

Note:
Lanyard material: Stainless steel
Eyelet material: Nickel-plated brass

B●● Blanking caps IP66 (water-resistant)

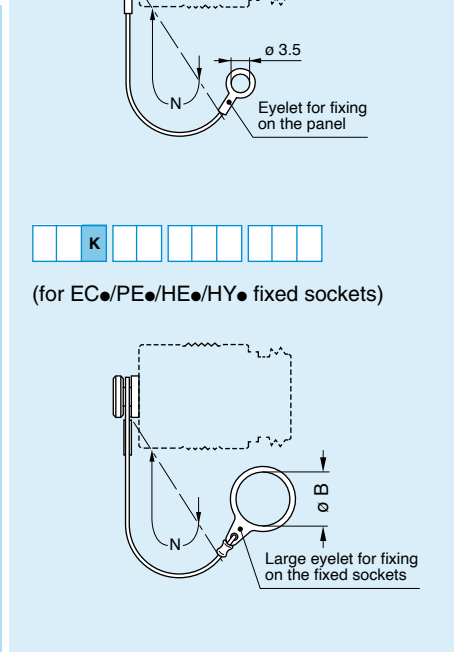
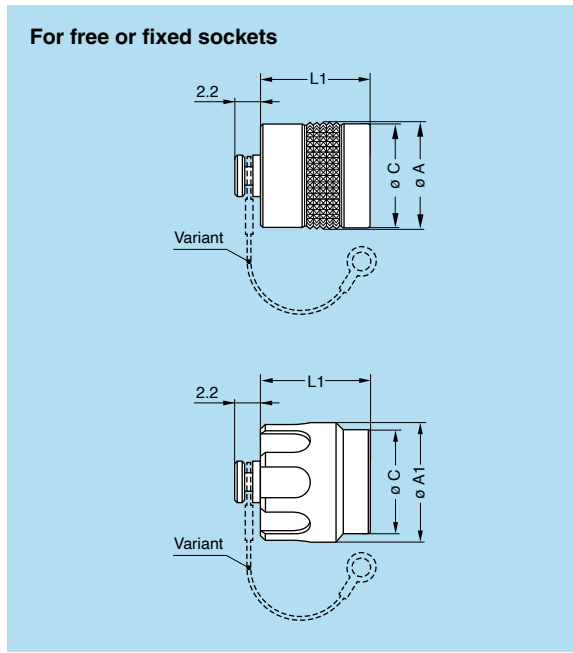
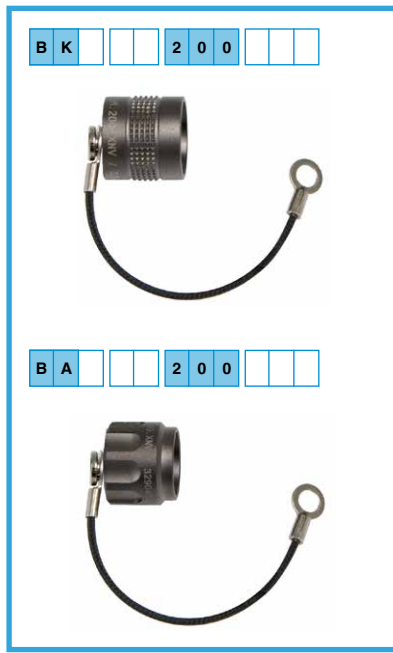
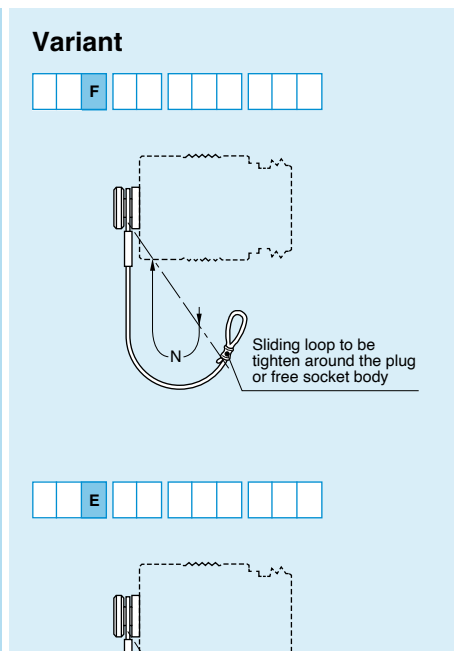
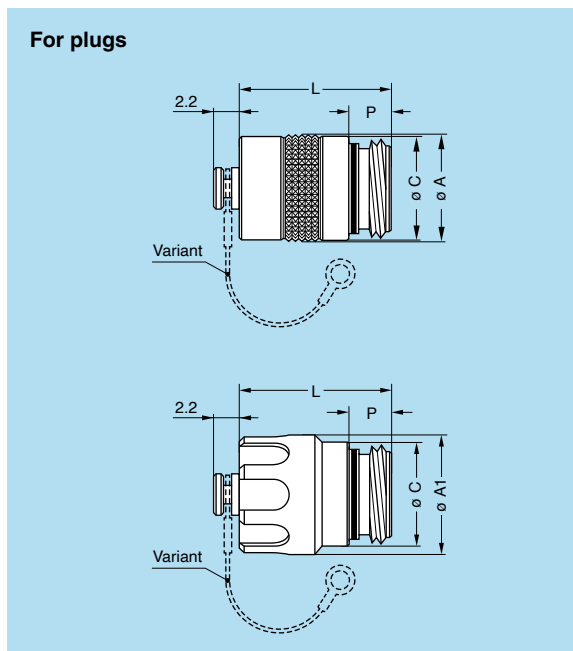
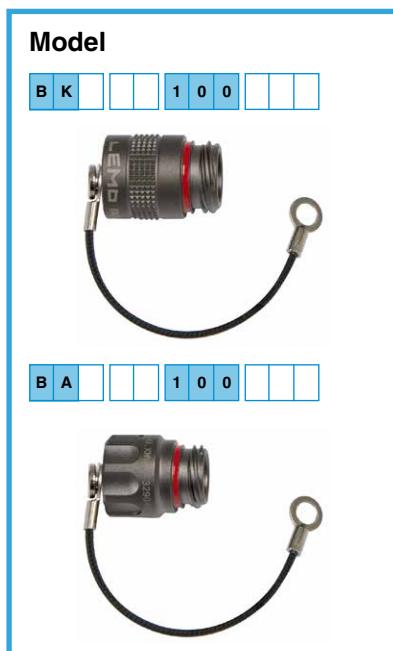

Part number for plugs	Dimensions (mm)						Dim. (mm)		Part number for free or fixed sockets
	A	A1	C	L	L1	P	B	N ¹⁾	
B●●.MM.100.●NV	11.1	12.0	10.7	14.8	9.9	3.7	10.1	70	B●●.MM.200.●NV
B●●.0M.100.●NV	13.1	14.4	12.7	17.3	12.0	5.3	13.1	90	B●●.0M.200.●NV
B●●.1M.100.●NV	14.6	15.9	14.2	17.3	12.0	5.3	14.1	90	B●●.1M.200.●NV
B●●.2M.100.●NV	17.6	18.9	17.2	17.3	12.0	5.3	17.2	90	B●●.2M.200.●NV
B●●.3M.100.●NV	19.6	20.9	19.2	17.3	12.0	5.3	19.2	110	B●●.3M.200.●NV
B●●.TM.100.●NV	22.5	23.4	22.0	21.1	15.5	7.9	22.2	110	B●●.TM.200.●NV
B●●.4M.100.●NV	25.0	25.9	24.5	21.1	15.5	7.9	24.2	110	B●●.4M.200.●NV
B●●.LM.100.●NV	28.5	29.4	28.0	21.1	15.5	7.9	28.2	130	B●●.LM.200.●NV
B●●.5M.100.●NV	34.0	34.9	33.5	21.1	15.5	7.9	33.2	130	B●●.5M.200.●NV

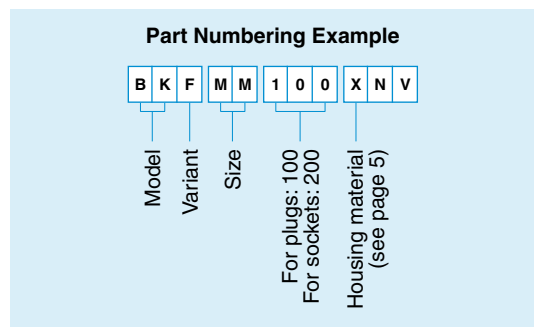

Note:
Lanyard material: Polyamide 6, black
Eyelet material: Nickel-plated brass

Note: ¹⁾ the tolerance on this dimension is ± 5 mm.

GEA Hexagonal nuts for EC• model

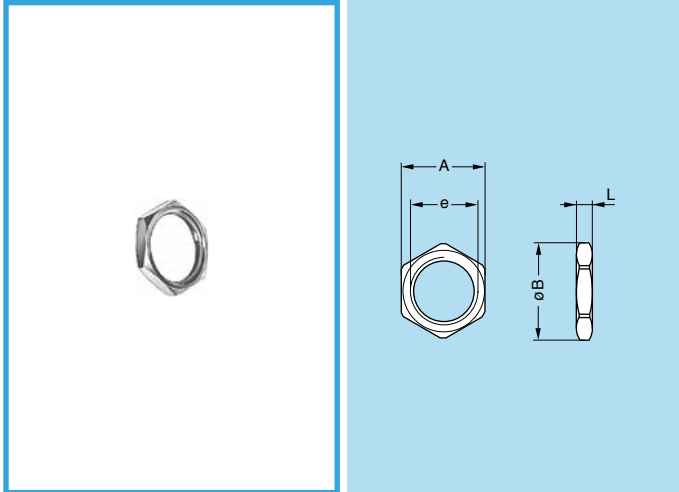

Part number	Series	Dimensions (mm)			
		A	B	e	L
GEA.MM.241.RL	MM	12.0	13.5	M10x0.50	2.5
GEA.0M.241.RL	0M	16.0	18.2	M13x0.75	2.5
GEA.0E.240.RL	1M	17.0	19.2	M14x1.00	2.5
GEA.2M.241.RL	2M	19.0	21.5	M17x1.00	3.0
GEA.3M.241.RL	3M	25.0	22.0	M19x1.00	3.0
GEA.TM.241.RL	TM	25.0	28.0	M22x1.00	3.0
GEA.4M.241.RL	4M	30.0	34.0	M24x1.00	3.0
GEA.LM.241.RL	LM	32.0	36.0	M28x1.00	3.0
GEA.5M.241.RL	5M	37.0	41.0	M33x1.00	3.0

Note: see page 41 for torque values.

● Material: Nickel-plated aluminium alloy

GEA Hexagonal nuts for EG• model

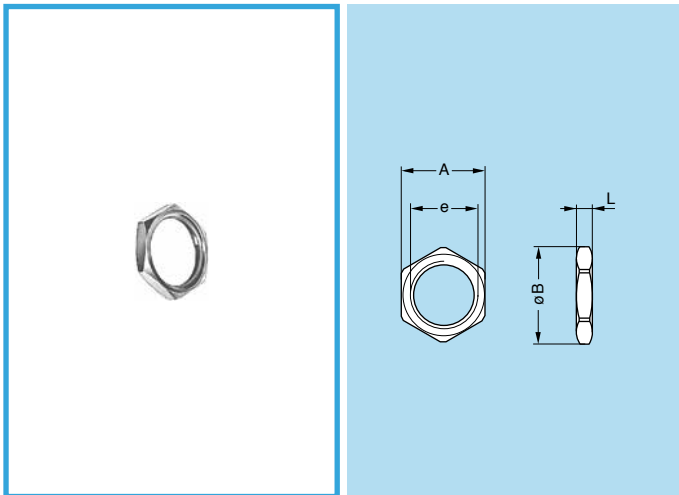

Part number	Series	Dimensions (mm)			
		A	B	e	L
GEA.00.240.RL	MM	9.0	10.2	M7x0.50	2.0
GEA.0S.240.RL	0M	11.0	12.4	M9x0.60	2.0
GEA.1M.240.RL	1M	13.0	14.5	M11x1.00	2.5
GEA.0E.240.RL	2M	17.0	19.2	M14x1.00	2.5
GEA.1E.240.RL	3M	19.0	21.5	M16x1.00	3.0
GEA.3S.240.RL	TM	22.0	25.0	M18x1.00	3.0
GEA.4M.240.RL	4M	25.0	28.0	M21x1.00	4.0
GEA.3E.240.RL	LM	30.0	34.0	M24x1.00	5.0
GEA.5M.240.RL	5M	36.0	40.5	M30x1.00	5.0

Note: see page 41 for torque values.

● Material: Nickel-plated aluminium alloy

GEC Conical nut for models HE•, HY•, EC•, PE•

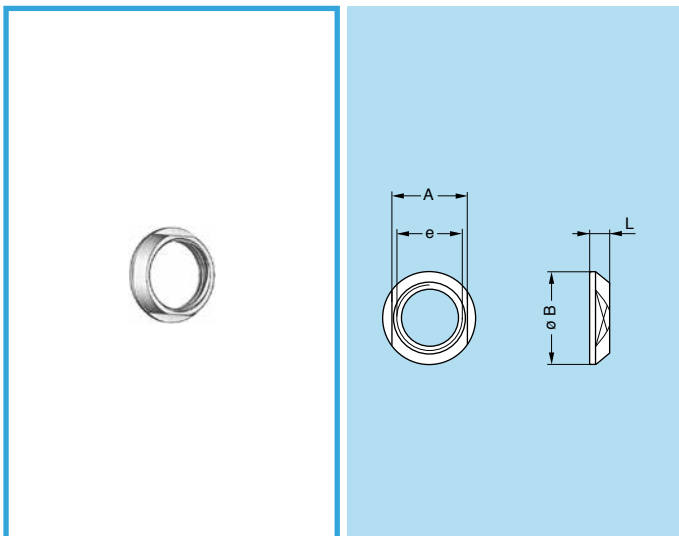

Part number	Series	Dimensions (mm)			
		A	B	e	L
GEC.MM.240.RN	MM	11.0	14.0	M10x0.50	2.5
GEC.0M.240.RN	0M	14.0	17.0	M13x0.75	3.2
GEC.0E.240.RN	1M	16.0	18.0	M14x1.00	3.0
GEC.2M.240.RN	2M	18.0	21.0	M17x1.00	3.2
GEC.3M.240.RN	3M	20.0	23.0	M19x1.00	3.2
GEC.TM.240.RN	TM	23.0	27.0	M22x1.00	5.0
GEC.4M.240.RN	4M	25.0	29.0	M24x1.00	5.0
GEC.LM.240.RN	LM	29.0	33.0	M28x1.00	5.0
GEC.5M.240.RN	5M	34.0	38.0	M33x1.00	5.0

● Material: Nickel-plated aluminium alloy (anthracite colour)

Note: see page 39 for insert conical nut tightening tools and page 41 for torque values.

Standard heatshrink boot

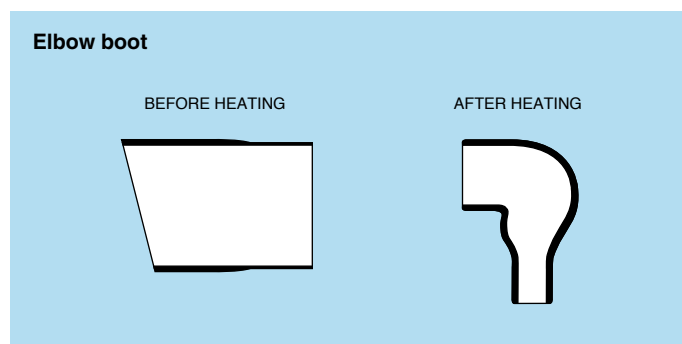
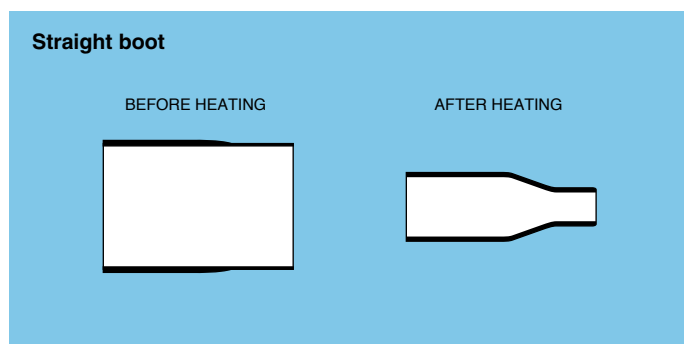

Series	Straight		Elbow 90°		Note	Cable ø min. (mm)
	Part number Raychem®	Part number LEMO	Part number Raychem®	Part number LEMO		
MM	–	GMA.10.290.DN	–	GHA.10.210.DN	2)	2.2
0M-2M	202 A 111-25/86	GMA.16.254.DN	222 A 111-25/86	GHA.18.170.DN	1)	3.8
2M-4M	202 A 121-25/86	GMA.24.380.DN	222 A 121-25/86	GHA.25.200.DN	1)	5.3
4M-5M	202 A 142-25/86	GMA.31.670.DN	222 A 142-25/86	GHA.32.360.DN	1)	7.4

Note:

1) modified elastomer resistant to fluids with hot melt sealant.

2) elastomer resistant to fluids. We recommend a thermosetting sealant with this type of boot.

Lipped heatshrink boot (for use with molded shapes, see page 6)

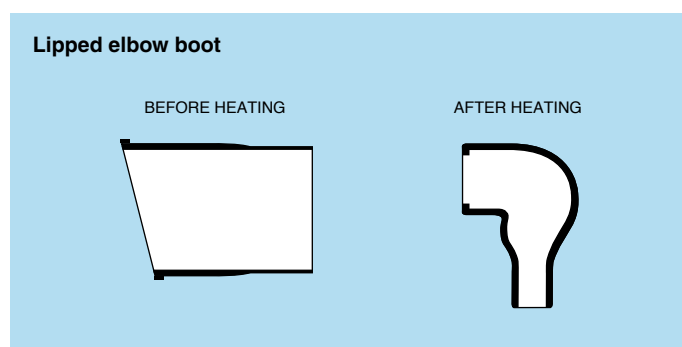
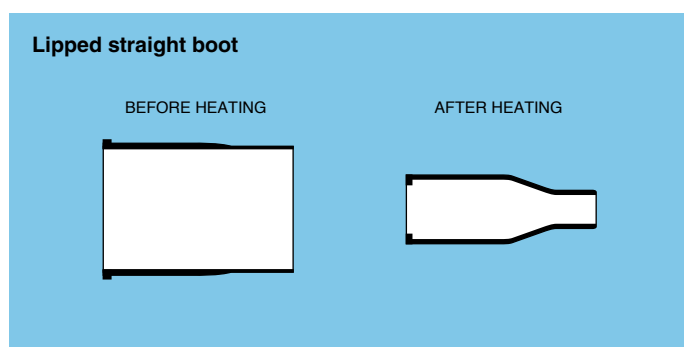

Series	Straight		Elbow 90°		Cable ø min. (mm)
	Part number Raychem®	Part number LEMO	Part number Raychem®	Part number LEMO	
MM	204 W 201-25/225	GMP.10.020.DN	224 W 201-25/225	GHP.11.013.DN	1.5
0M	204 W 221-25/225	GMP.11.019.DN	224 W 221-25/225	GHP.11.012.DN	2.1
1M-2M	202 F 211-50-22	GMP.24.076.DN	222 F 211-50	GHP.24.105.DN	6.6
3M-4M	202 F 221-50-22	GMP.27.083.DN	222 F 221-50	GHP.27.124.DN	7.6
LM	202 F 232-50-22	GMP.31.089.DN	222 F 232-50	GHP.31.146.DN	8.9
5M	202 F 242-50-22	GMP.36.102.DN	222 F 242-50	GHP.35.172.DN	10.2

FGN M series constant force spring clips



A range of constant force spring clips are available for use with M Series connectors, which permits repair of cable terminations without having to discard any of the existing braid shield system. When used in conjunction with LEMO heatshrink boots, a fully sealed termination is achieved. An additional benefit of the constant force spring is that it provides excellent resistance to shock or vibration due to its self-tensioning properties.

Part number	Series	Number of wraps	Width (mm)
FGN.0M.185.AZ	0M / 1M / 2M	4.3 / 3.5 / 2.6	4.0
FGN.3M.185.AZ	3M / TM	2.5 / 2.3	4.0
FGN.5M.185.AZ	4M / LM / 5M	1.8 / 1.5 / 1.2	4.0

Tie-wrap



	Part number	
	TIE-DEX®	AXON®
Tie wrap	A31089	AXCL 02

Note: tie wrap are used to ensure the best possible ground contact and fixture between the cable screen and the connector backshell. The tie wrap are delivered by set of 100 pieces.

Accessories for Fibre Optic

GMA Bend relief (for M series fibre optic model only)

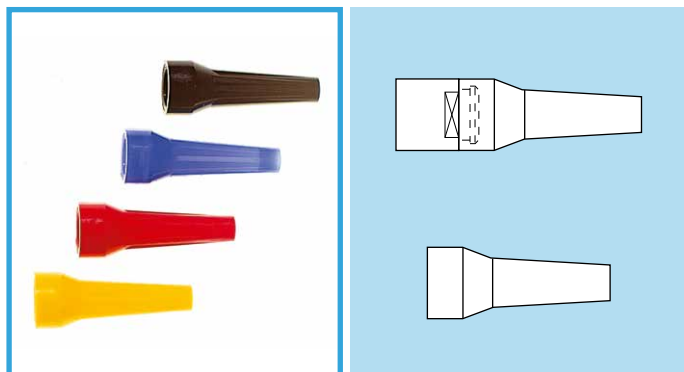

A bend relief can be fitted over LEMO plugs and sockets supplied with a specific collet nut.

These bend relieves are available in different colours and two different materials. TPU (Thermoplastic Polyurethane) is the standard choice for most applications. Silicone elastomer VMQ option can be selected where the applications required a wide temperature range (silicone material keeps a good flexibility over the full temperature range).

Main characteristics

- Material: TPU (Thermoplastic Polyurethane)
- Temperature range in dry atmosphere: -40°C +80°C
- Material: Silicone elastomer VMQ
- Temperature range in dry atmosphere: -60°C +200°C
- Temperature range in water steam: +140°C

Part number (Polyurethane)	Series	Part number (Silicone)
GMA.2B.0**.DG	2M	GMA.2B.0**.RG
GMA.3B.0**.DG	3M	GMA.3B.0**.RG
GMA.4B.0**.DG	5M	GMA.4B.0**.RG

Ref.	Colour	Ref.	Colour	Ref.	Colour
A	blue	J	yellow	R	red
B	white	M	brown	S	orange
G	grey	N	black	V	green

Note: please see unipole/multipole catalogue for bend relief dimensions. The last letter «G» of the part number indicates the grey colour of the bend relief. For ordering a bend relief with another colour, see table on the right and replace the letter «G» by the letter of the required colour.

PSS.F7.290.NZZ Alignment device for F7 Fibre Optic contact

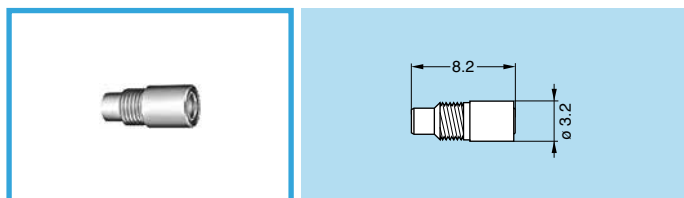

Alignment device are supplied as default with all female fibre optic contacts, this item is a spare accessory for maintenance purposes.

Note: alignment device should be ordered as replacement item.

Tooling

DPC Manual crimping tool

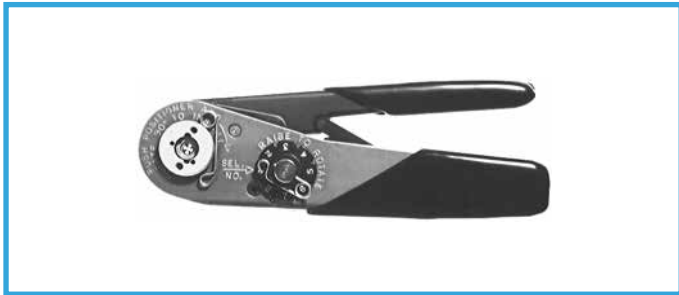

Part number

DPC.91.701.V

According to specification MIL-C-22520/7-01.
For LEMO contacts \varnothing 0.5-0.7-0.9-1.3 mm

DCE Positioners for crimp contacts

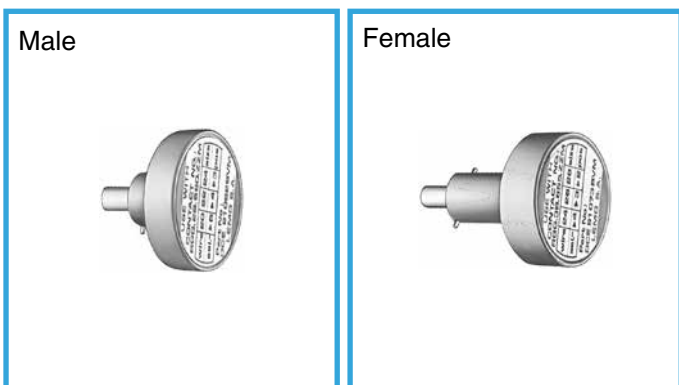

These positioners are suitable for use with both manual and pneumatic crimping tools according to the MIL-C-22520/7-01 standard.

Contact		Positioners part number	
Contact \varnothing	Size	For male contacts	For female contacts
1.3	0M-5M	DCE.91.130.5MVC	DCE.91.130.5MVM
0.9	0M-3M	DCE.91.090.5MVC	DCE.91.090.3MVM
	TM-5M	DCE.91.090.5MVC¹⁾	DCE.91.09T.5MVM
0.7	0M-3M	DCE.91.070.5MVC	DCE.91.070.3MVM
	2M.514	DCE.91.072.MVCM	DCE.91.072.MVCM
	TM-5M	DCE.91.070.5MVC	DCE.91.07T.5MVM
0.5	MM	DCE.91.050.0VC	DCE.91.050.0VM

Note: ¹⁾ the positioner part number for male contact for the serie 5M.G33 is DCE.91.90.5MVCY.

DCC Manual extractors for crimp contacts



Contact \varnothing	Part number
1.3	DCC.13.15B.LAG
0.9	DCC.09.05B.LAG
0.7	DCC.07.04B.LAG
0.5	DCC.05.02B.LAG

Note: this model is used for male and female contacts.

DCV Female contact insertion tool

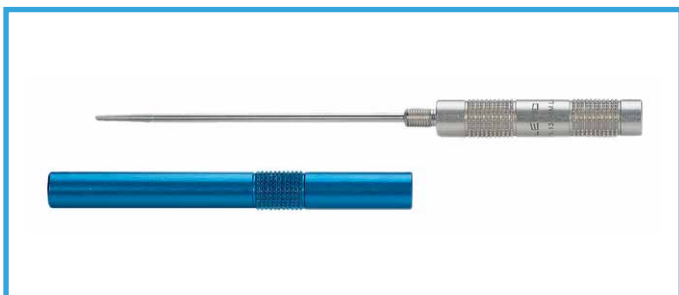

Contact \varnothing	Part number
1.3	DCV.13.05M.LA
0.9	DCV.09.05M.LA
0.7	DCV.07.05M.LA
0.5	DCV.05.05M.LA

Banding tool



	Part number	
	TIE-DEX®	AXON®
Banding tool	A30199	ACDBS100

DCM Insert conical nut tightening tools

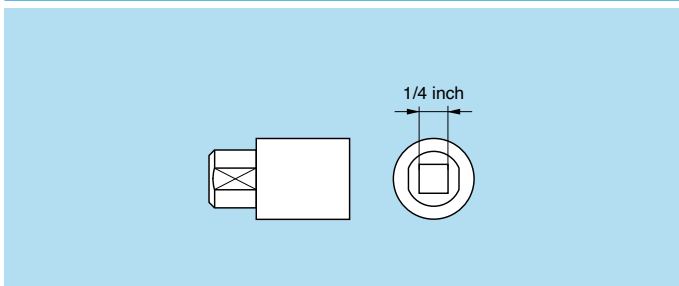

Part number	Series	Torque (Nm)	For models
DCM.65.110.AZ	MM	1.0	EC●, HE●, PE●
DCM.65.140.AZ	0M	1.0	EC●, HE●, PE●
DCM.65.160.AZ	1M	1.5	EC●, HE●, PE●
DCM.65.180.AZ	2M	2.0	EC●, HE●, PE●
DCM.65.200.AZ	3M	2.5	EC●, HE●, PE●
DCM.65.230.AZ	TM	4.0	EC●, HE●, PE●
DCM.65.250.AZ	4M	5.0	EC●, HE●, PE●
DCM.65.290.AZ	LM	6.5	EC●, HE●, PE●
DCM.65.340.AZ	5M	8.0	EC●, HE●, PE●

Note: for standard 1/4 inch tools adaptor. See conical nut on page 34.

Tooling for Fibre Optique

DCP Set of flat spanners for collet nuts



Part number	Series
DCP.2M.110.TN	2M
DCP.3M.110.TN	3M
DCP.5M.110.TN	5M

Note: for width across flats, see page 19.

DCS.F7.035.PN F7 contact alignment device tool



Simple tool with two threaded end for installation/extraction of the F7 contact alignment device.

See also F7 tooling in the F7 Fibre Optic catalog.

WST.KI.125.34 Cleaning kit



Fibre optic cleaning kit of 2 cotton buds, 1 dry and 1 being soaked in Isopropyl Alcohol used for cleaning the fibre optic contacts.

Tooling for High Power

Standard crimping tool for High Power contacts



Series	Contact \varnothing (mm)	Wire section		Crimping tool Klauke ¹⁾		
		mm ²	AWG	K05	K06	K35/4
3M	4.0	10	8	●	●	●
TM	5.0	16	6	●	●	●
4M	6.0	25	4	●	●	●
LM	8.0	35	2		●	●
5M	8.0	50	1		●	●

Note: ¹⁾ for cable lugs and connector standard type.

Chamber hexagonal crimp dimensions for High Power contacts

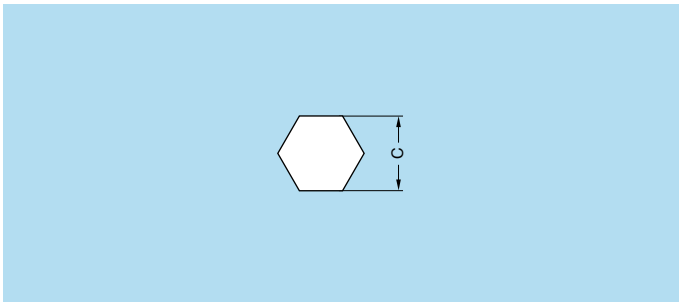

Series	Contact \varnothing (mm)	Wire section		Chamber crimp
		mm ²	AWG	Dimension C (mm)
3M	4.0	10	8	5.6
TM	5.0	16	6	6.6
4M	6.0	25	4	7.8
LM	8.0	35	2	10.0
5M	8.0	50	1	11.0

DCC Extraction tools for High Power contacts



Extractors part number for male and female contacts	Series	Contact \varnothing (mm)
DCC.91.43H.PLC	3M.H14, 5M.H34, 5M.G33	4.0
DCC.91.5TH.PLC	TM.H15	5.0
DCC.91.64H.PLC	4M.H16	6.0
DCC.91.8LH.PLC	LM.H18	8.0
DCC.91.85H.PLC	5M.H18	8.0

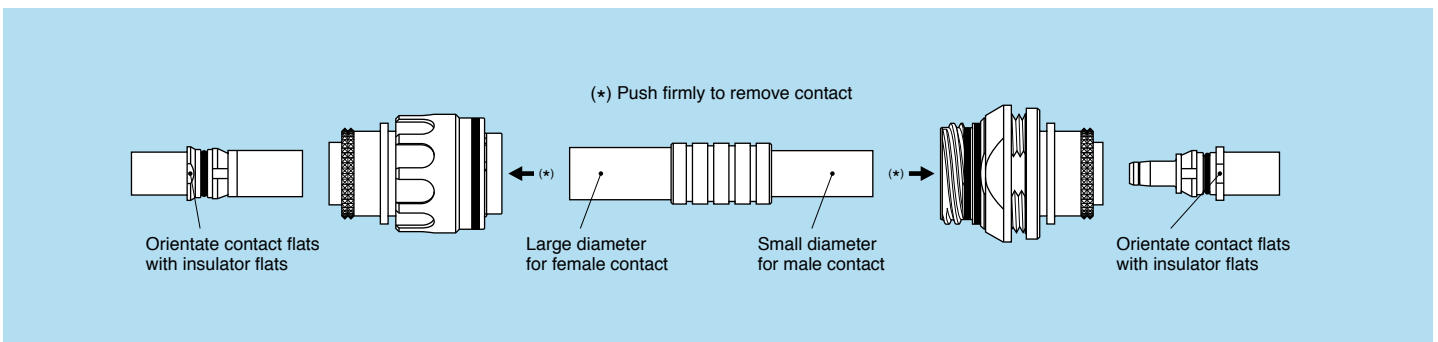

Panel cut-outs

Cut-outs

Mounting nut torque (on panel)

EG●-EC●-HE●-HY●-PE●

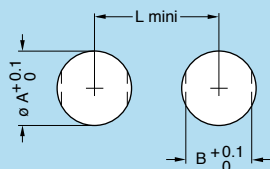

Series	EG●			EC●/HE●/HY●/PE●		
	$\varnothing A$	B	L	$\varnothing A$	B	L
MM	7.1	6.4	12.5	10.1	9.1	16.0
0M	9.1	8.3	14.5	13.1	11.6	20.0
1M	11.1	9.6	17.2	14.1	12.6	21.0
2M	14.1	12.6	20.5	17.1	15.6	24.0
3M	16.1	14.6	23.0	19.1	17.6	27.0
TM	18.1	16.6	27.0	22.1	20.6	31.5
4M	21.1	19.6	30.0	24.1	22.6	35.5
LM	24.1	22.6	32.0	28.1	26.6	36.5
5M	30.1	28.6	41.0	33.1	31.6	41.0

Series	Torque (Nm)
MM	1.0
0M	1.0
1M	1.5
2M	2.0
3M	2.5
TM	4.0
4M	5.0
LM	6.5
5M	8.0

ED●-FA●-FW●-FX●-PV●-PT●-PF●

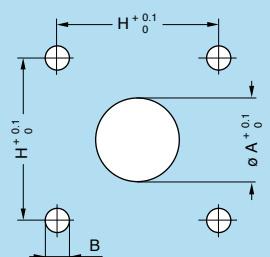

Series	ED●			FA●/FW●/FX●			PV●/PT●			PF●		
	$\varnothing A$	B	H	$\varnothing A$	B	H	$\varnothing A$	B	H	$\varnothing A$	B	H
MM	5.0	M2.5	9.5	9.6	M2.5	12.0	11.8	M2.5	12.0	7.9	M2.5	9.5
0M	5.1	M2.5	11.0	12.3	M2.5	15.1	15.0	M2.5	15.1	10.8	M2.5	11.0
1M	6.1	M3.0	12.9	13.8	M3.0	18.3	17.0	M3.0	18.3	12.5	M3.0	12.9
2M	9.1	M3.0	15.1	16.8	M3.0	20.6	20.0	M3.0	20.6	15.6	M3.0	15.1
3M	11.1	M3.0	16.6	18.8	M3.0	20.6	22.0	M3.0	23.0	18.1	M3.0	16.6
TM	12.5	M3.0	18.3	21.6	M3.0	23.0	25.0	M3.0	24.6	19.9	M3.0	18.3
4M	14.1	M3.0	20.6	24.1	M3.0	24.6	28.0	M3.0	27.0	22.7	M3.0	20.6
LM	18.1	M3.0	23.0	27.6	M3.0	27.0	31.0	M3.0	29.4	25.9	M3.0	23.0
5M	23.2	M3.0	27.0	33.1	M3.0	29.4	38.0	M3.0	34.9	33.1	M3.0	29.4

PB●

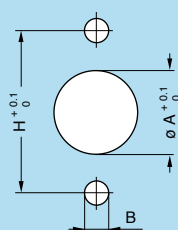

Series	PB●		
	$\varnothing A$	B	H
MM	11.8	M2.5	16.2
0M	15.0	M3.0	21.4
1M	17.0	M3.0	23.4
2M	20.0	M3.0	26.4
3M	22.0	M3.0	29.0
TM	25.0	M3.0	32.5
4M	28.0	M3.0	35.0
LM	31.0	M3.0	38.0
5M	38.0	M3.0	45.0

HE●, EG●, EC● and ED● models PCB drilling pattern

Fixed socket with straight print contact

For HE● models

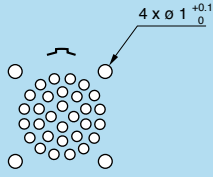

For EG●, EC● and ED● models



MM.303

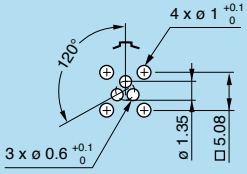

MM.304

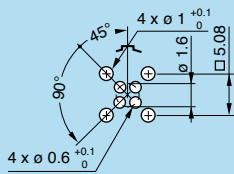

OM.302

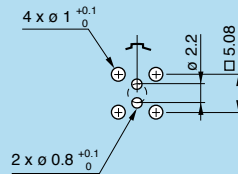

OM.303

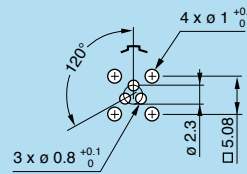

OM.304

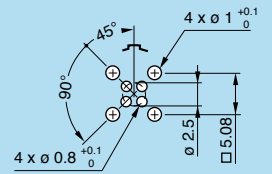

OM.305

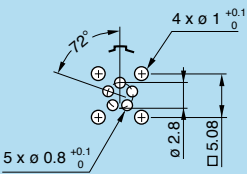

1M.302

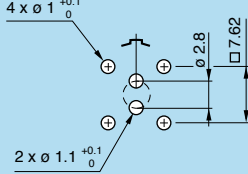

1M.303

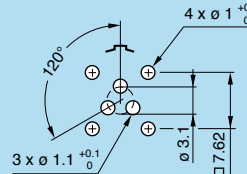

1M.304.●R 1)

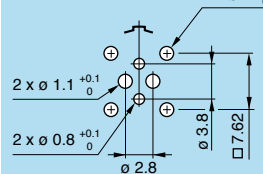

1M.305

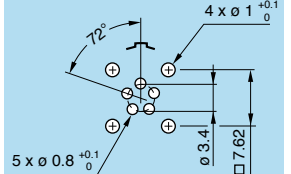

1M.307

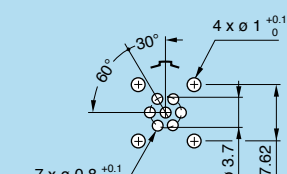

1M.308

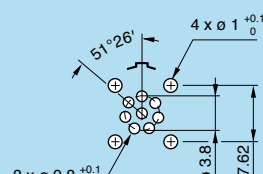

2M.304

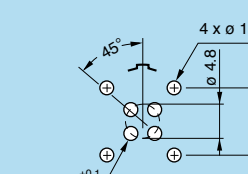

2M.306.●R 1)

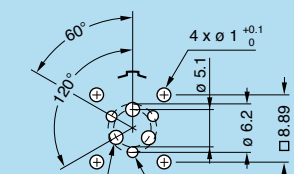

2M.308

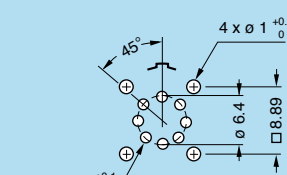

2M.308.●R 1)

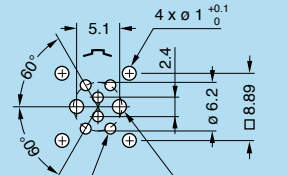

2M.310

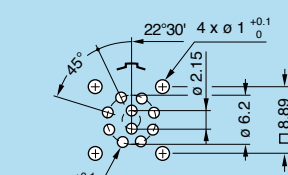

2M.310.●R 1)

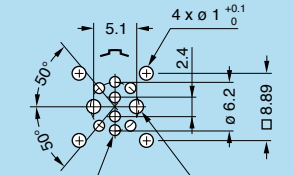

2M.312

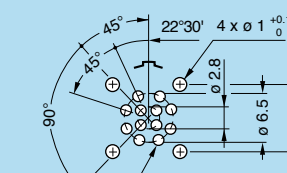

2M.316

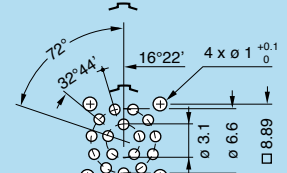

2M.319

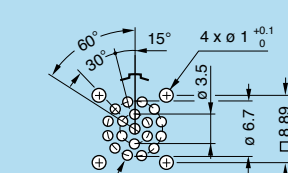

2M.514

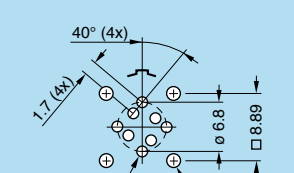

Note: 1) special mixed multipole configurations, refer to page 26 for details.

3M.312

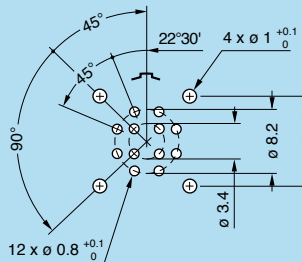

3M.316.●R1)

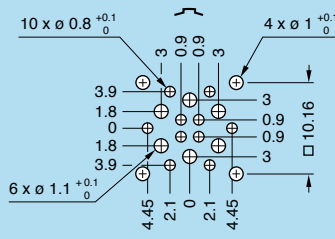

3M.322

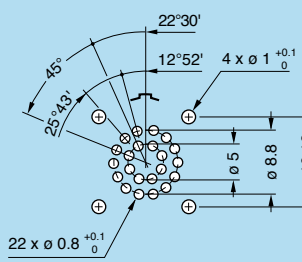

3M.330

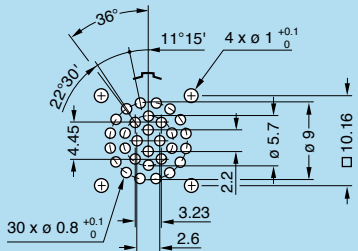

TM.325

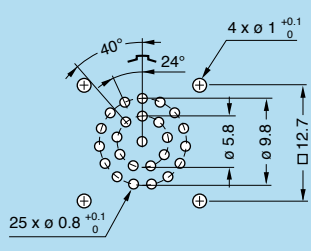

TM.332

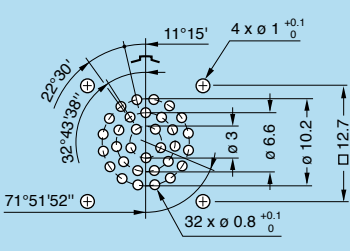

TM.340

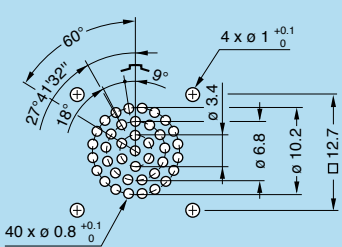

4M.340

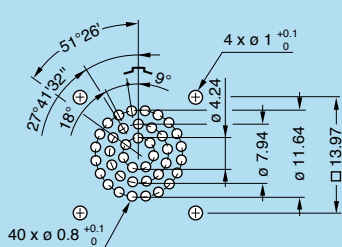

4M.348

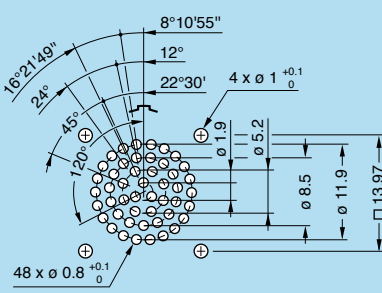

LM.355

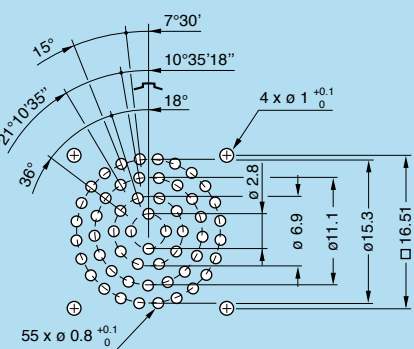

LM.368

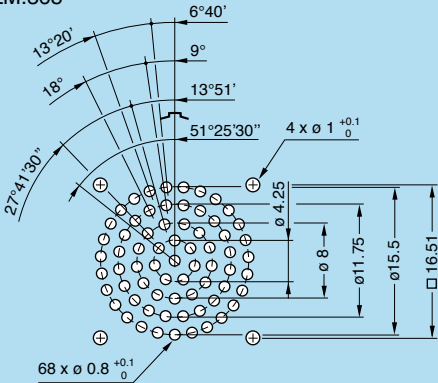

5M.366

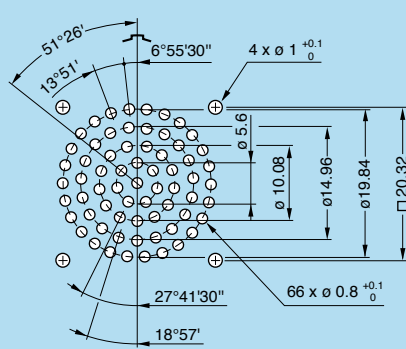

5M.366.●R1)

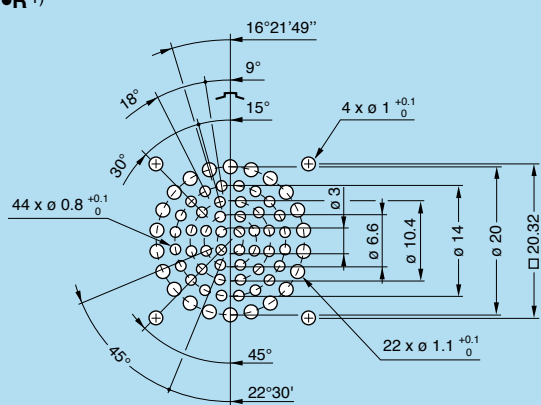

5M.114

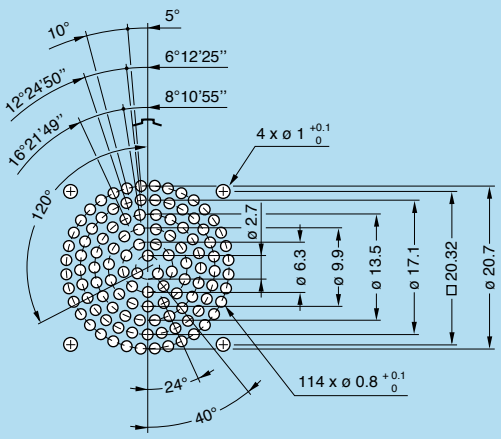

HY● model PCB drilling pattern

Fixed socket with straight print contact

For HY● models (with ground pin)

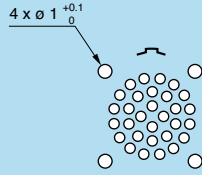

For HY● models (with threaded holes)

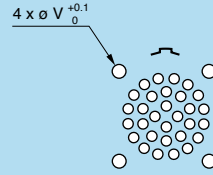

Series	ø V (mm)
MM to 3M	2.1
TM to 5M	3.1

MM.303

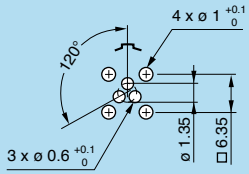

MM.304

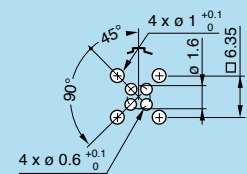

OM.302

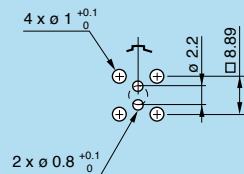

OM.303

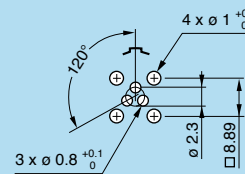

OM.304

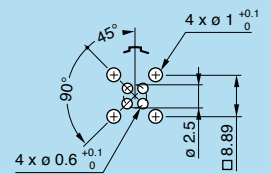

OM.305

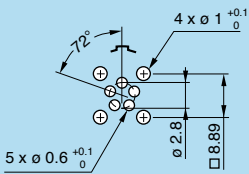

1M.302

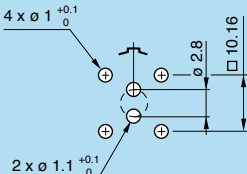

1M.303

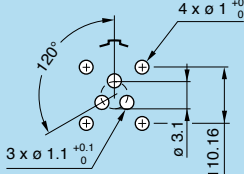

1M.304.●R 1)

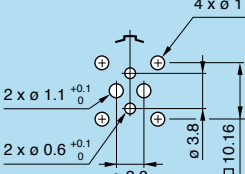

1M.305

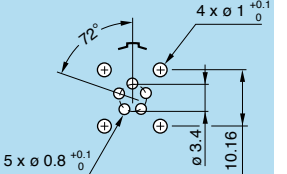

1M.307

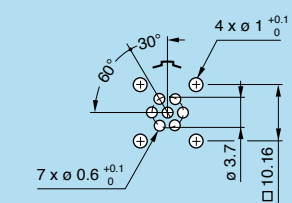

1M.308

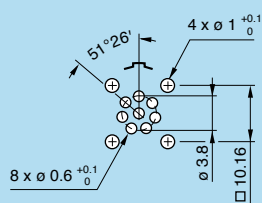

2M.304

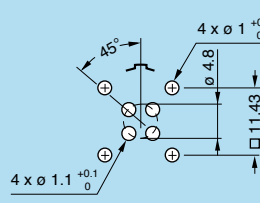

2M.306.●R 1)

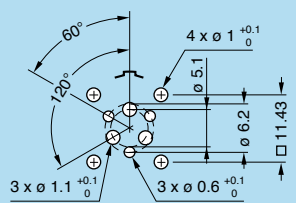

2M.308

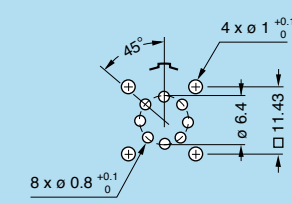

2M.308.●R 1)

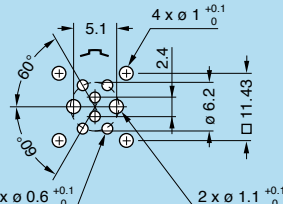

2M.310

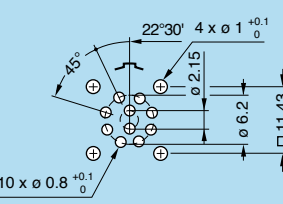

2M.310.●R 1)

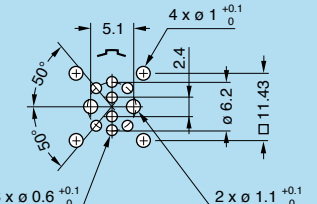

2M.312

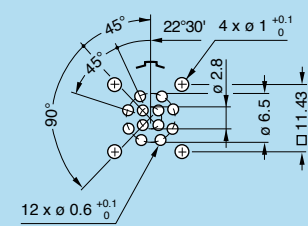

2M.316

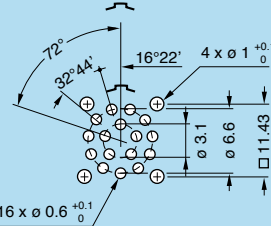

2M.319

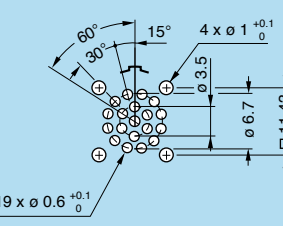

2M.514

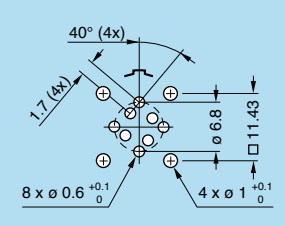

Note: 1) special mixed multipole configurations, refer to page 26 for details.

3M.312

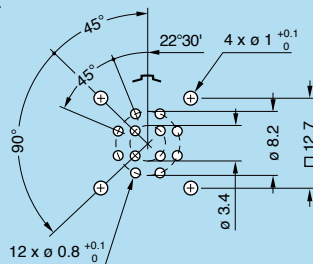

3M.316.●R 1)

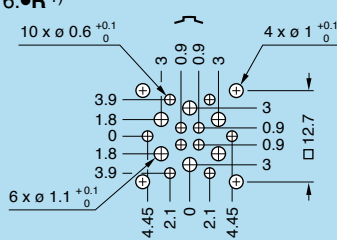

3M.322

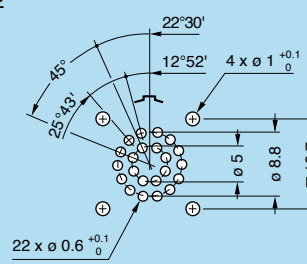

3M.330

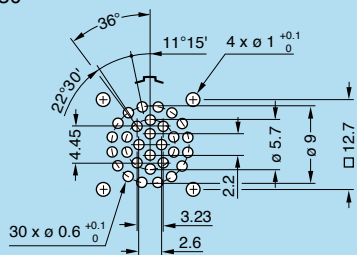

TM.325

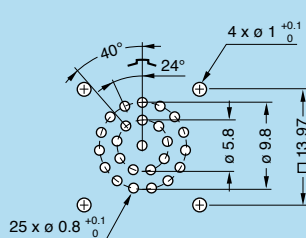

TM.332

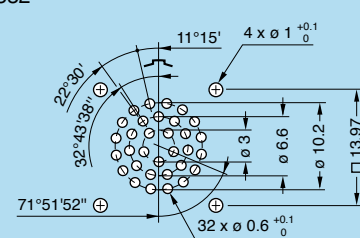

TM.340

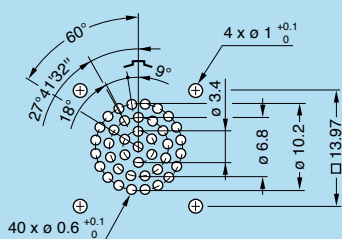

4M.340

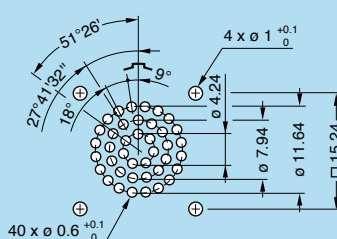

4M.348

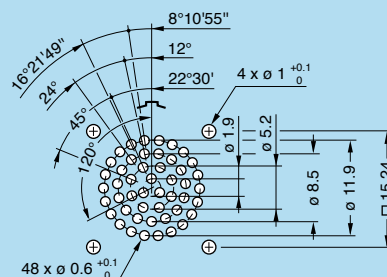

LM.355

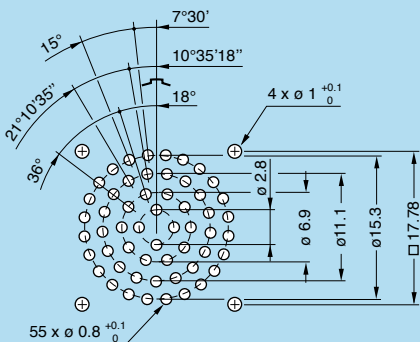

LM.368

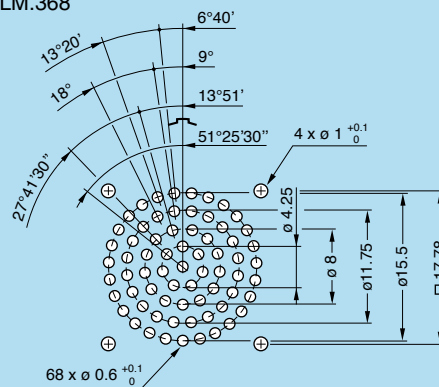

5M.366

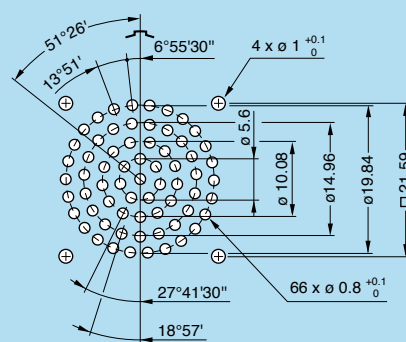

5M.366.●R 1)

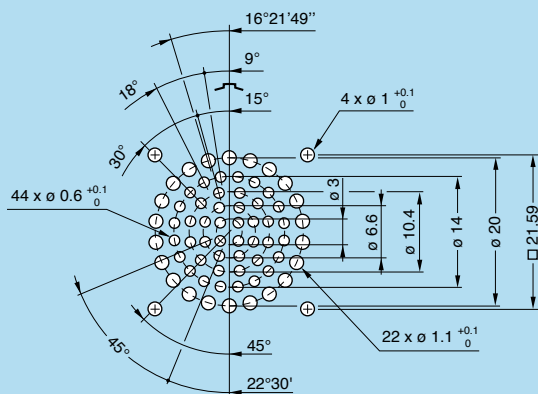

5M.114

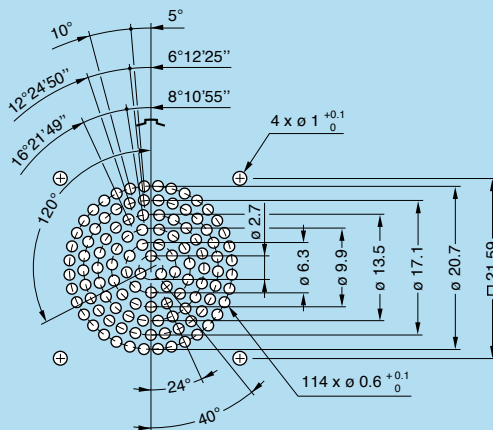

Assembly instructions for cable mounted models

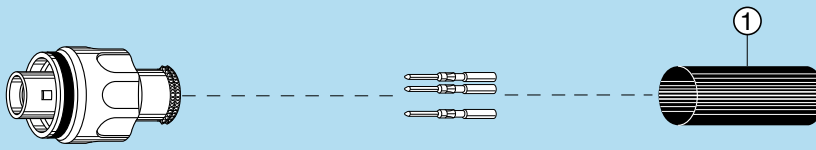

① heatshrink boot option to be ordered separately

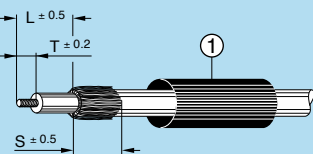
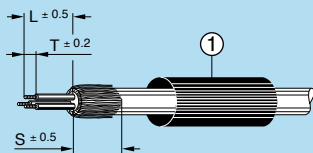

① heatshrink boot to be placed on cable if desired

Cable preparation

- Remove cable jacket and resses the shield onto the cable (shield can be temporary fixed using adhesive tape).
- Strip the cable elements using the dimensions specified in the table below. Dimensions must be selected according to the backshell variant in use.

Multipole

Series	Cable stripping length ¹⁾²⁾ (mm)					
	P●● / FG●● / FM●●			FA●● / FX●● / FW●●		
	L	S	T ³⁾	L	S	T ³⁾
MM	16	23	3.0	21	23	3.0
0M	16	23	3.5	21	23	3.5
1M	16	23	3.5	21	23	3.5
2M	18	27	3.5	23	27	3.5
3M	18	27	3.5	23	27	3.5
TM	20	30	3.5	26	30	3.5
4M	20	30	3.5	26	30	3.5
LM	20	30	3.5	26	30	3.5
5M	20	30	3.5	26	30	3.5

Note:

- ¹⁾ indicative values, may need to be adapted according to your cable construction and specific pin allocation.
- ²⁾ for mixed, high speed, USB 2.0, fibre optic models please contact technical support for specific stripping length.
- ³⁾ for 1.3 mm contact «T» = 4 mm (1M.302/1M.303/2M.304).

High Power

Reference	Cable stripping length ¹⁾ (mm)					
	P●● / FG●● / FM●●			FA●● / FX●● / FW●●		
	L	S	T	L	S	T
3M.H14	24.0	33	10	24.0	27	10
TM.H15	24.0	33	10	24.0	27	10
4M.H16	24.0	33	12	24.0	27	12
LM.H18	27.0	39	13	27.0	33	13
5M.H18	27.0	39	13	27.0	33	13
5M.H34	24.0	30	10	24.0	25	10
5M.G33	24.0 27.5 ²⁾	30 30	10 3.5	24.0 27.5 ²⁾	25 25	10 3.5 ²⁾

Note:

- ¹⁾ indicative values, may need to be adapted according to your cable construction and specific pin allocation.
- ²⁾ low power contact.

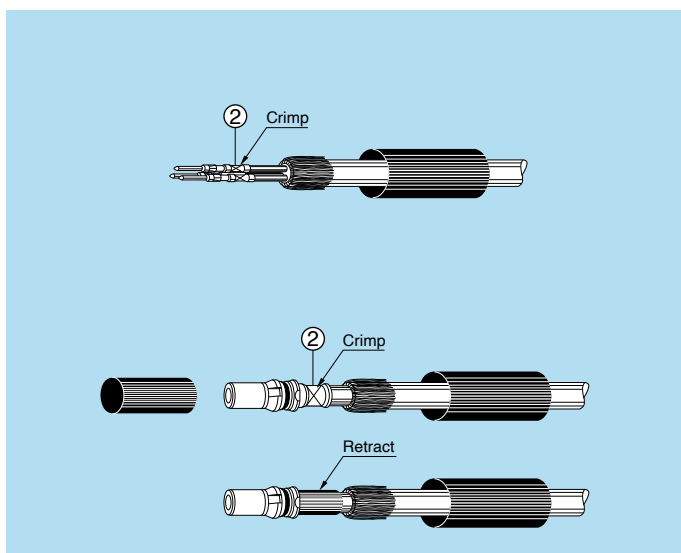

Contact crimping

Multipole versions

- Fix the appropriate positioner onto the crimping tool (see page 38).
- Set the tool selector on the corresponding AWG. Crimping tool setting can be found on the positioner label.
- Insert the conductor into the contact barrel ②; make sure that the conductor is visible through the contact's inspection hole.
- Slide the conductor-contact assembly into the crimping tool and push the contact fully into the positioner.
- Proceed with crimping and check that conductor is securely crimped in the contact. Also check that the conductor is still visible in the contact inspection hole.

High Power versions

- Select the appropriate crimping tool (see page 40).
- Insert the conductor into the contact barrel ②.
- Slide the conductor-contact assembly into the crimping tool.
- Proceed with crimping and check that conductor is securely crimped in the contact. Also check that all conductor strands are securely fixed into the contact barrel.
- Place the supplied heatshrink tube to cover the crimped zone and cable inner jacket.
- Retract the heatshrink tube in the desired position using a heat gun.

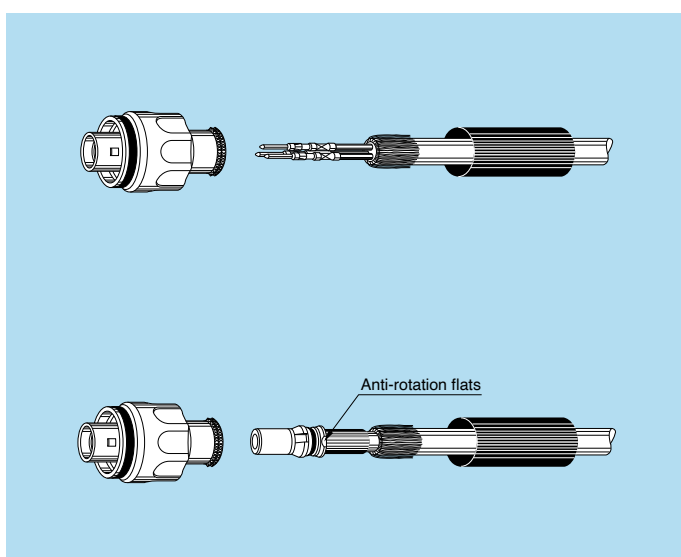

Contact insertion

Multipole versions

- Arrange the conductor-contact assemblies according to the desired pin layout.
- Push the contact firmly into the insulator until mechanical click can be felt. The use of tweezers can facilitate contact insertion.
- Check that all contacts are correctly located in the insulator by verifying:
 - 1) the alignment of the contacts at the front of the insulator.
 - 2) by gently pulling on each conductor to verify that they are properly secured into the insulator.
- In case a crimp contact must be disassembled from insulator extraction tool can be found on page 38.

High Power versions

- Arrange the conductor-contact assemblies according to the desired pin layout (multipole only).
- Insert the contact into the insulator, aligning the anti-rotation flats of the contact with the corresponding anti-rotation lugs inside the insulator.
- Push the contact firmly into the insulator until mechanical click can be felt.
- Check that the contact is correctly secured by gently pulling on the conductor.

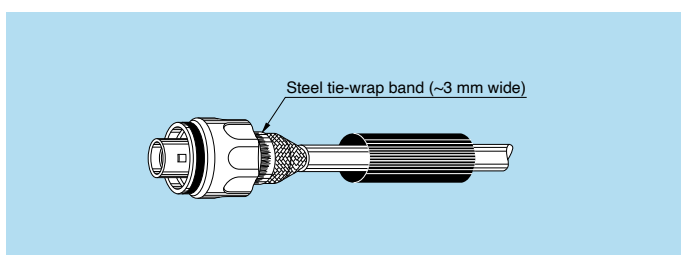

Braid connection

- Bring the braid around the backshell of the connector.
- Position the braid fixing accessory (tie-wrap or constant force spring clips, to be ordered separately).
- Proceed to braid fixing accessory installation using the dedicated tool.
- Recess the excess braid over the braid fixing accessory and trim the excess length.

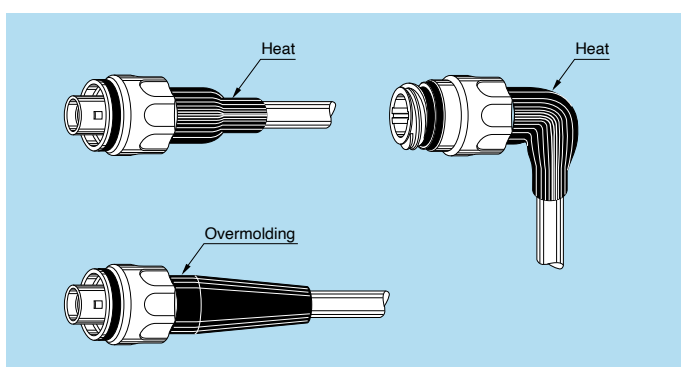

Bend relief installation

Heatshrink boot versions

- Position the heatshrink boot (to be ordered separately) over the backshell by taking special care of keeping the braid in position under the boot.
- Gently retract the heatshrink boot using a heat gun.

Overmolding versions

- For overmolding versions previous steps like contact insertion might need special preparation according to overmolding process in use. Contact us for details on specific overmolding preparation.

Note: the elbow version is not recommended for High Power versions.

Note:

Product safety notice

PLEASE READ AND FOLLOW ALL INSTRUCTIONS CAREFULLY AND CONSULT ALL RELEVANT NATIONAL AND INTERNATIONAL SAFETY REGULATIONS FOR YOUR APPLICATION. IMPROPER HANDLING, CABLE ASSEMBLY, OR WRONG USE OF CONNECTORS CAN RESULT IN HAZARDOUS SITUATIONS.

1. SHOCK AND FIRE HAZARD

Incorrect wiring, the use of damaged components, presence of foreign objects (such as metal debris), and / or residue (such as cleaning fluids), can result in short circuits, overheating, and / or risk of electric shock. Mated components should never be disconnected while live as this may result in an exposed electric arc and local overheating, resulting in possible damage to components.

2. HANDLING

Connectors and their components should be visually inspected for damage prior to installation and assembly. Suspect components should be rejected or returned to the factory for verification. Connector assembly and installation should only be carried out by properly trained personnel. Proper tools must be used during installation and / or assembly in order to obtain safe and reliable performance.

3. USE

Connectors with exposed contacts should never be live (or on the current supply side of a circuit). Under general conditions voltages above 30 VAC and 42 VDC are considered hazardous and proper measures should be taken to eliminate all risk of transmission of such voltages to any exposed metal part of the connector.

4. TEST AND OPERATING VOLTAGES

The maximum admissible operating voltage depends upon the national or international standards in force for the application in question. Air and creepage distances impact the operating voltage; reference values are indicated in the catalog however these may be influenced by PC board design and / or wiring harnesses. The test voltage indicated in the catalog is 75% of the mean breakdown voltage; the test is applied at 500 V/s and the test duration is 1 minute.

5. CE MARKING

CE marking  means that the appliance or equipment bearing it complies with the protection requirements of one or several European safety directives.

CE marking  applies to complete products or equipment, **but not to electromechanical components, such as connectors.**

6. PRODUCT IMPROVEMENTS

The LEMO Group reserves the right to modify and improve to our products or specifications without providing prior notification.

7. **WARNING (Prop 65 State of California)**

Proposition 65 requires businesses to provide warnings to Californians about significant exposures to chemicals that cause cancer, birth defects or other reproductive harm. LEMO products are exempt from proposition 65 warnings because they are manufactured, marketed, and sold solely for commercial and industrial use. For further information, please visit <https://www.lemo.com/quality/LEMO-Prop-65-compliance-declaration.pdf>.

Disclaimers

LEMO works constantly to improve the quality of its products; the information and illustrations figuring in this document may therefore vary and are not binding. In any case, LEMO makes no specific warranty of merchantability, fitness for a particular purpose, third party components as such or included in assembly, non-infringement, title, accuracy, completeness, or security. The user is fully responsible for his products and applications using LEMO component.

In no event shall LEMO, its affiliates, officers, agents or employees be liable for any incidental, indirect, special or consequential damages in connection with the products or services provided by LEMO, including (without limitation) loss of profits or revenues, interruption of business, loss of use of the products or any associated equipment, materials, components or products, damages to associated equipment or in combination with other components, materials.

Reproduction of significant portions of LEMO information in LEMO data books or data sheets is permissible only if reproduction is without alteration and is accompanied by all associated warranties, conditions, limitations, and notices. LEMO is not responsible or liable for such altered documentation. Information of third parties may be subject to additional restrictions.



HEADQUARTERS

SWITZERLAND

LEMO SA
Tel: +41 21 695 16 00
info@lemo.com

SUBSIDIARIES

AUSTRIA

LEMO ELEKTRONIK GESMBH
Tel: +43 1 914 23 20 0
salesAT@lemo.com

BRAZIL

LEMO LATIN AMERICA LTDA
Tel: +55 11 94242 4293
info-la@lemo.com

CANADA

LEMO CANADA INC
Tel: +1 905 889 56 78
info-canada@lemo.com

CHINA / HONG KONG

LEMO ELECTRONICS
(SHANGHAI) CO., LTD
Tel: +86 21 5899 7721
cn.sales@lemo.com

DENMARK

LEMO DENMARK A/S
Tel: +45 45 20 44 00
info-dk@lemo.com

FRANCE

LEMO FRANCE SÀRL
Tel: +33 1 60 94 60 94
info-fr@lemo.com

GERMANY

LEMO ELEKTRONIK GMBH
Tel: +49 89 42 77 03
info@lemo.de

HUNGARY

REDEL ELEKTRONIKA KFT
Tel: +36 1 421 47 10
info-hu@lemo.com

ITALY

LEMO ITALIA SRL
Tel: +39 02 66 71 10 46
sales.it@lemo.com

JAPAN

LEMO JAPAN LTD
Tel: +81 3 54 46 55 10
info-jp@lemo.com

NETHERLANDS / BELGIUM

LEMO CONNECTORS
NEDERLAND B.V.
Tel: +31 232 06 07 01
info-nl@lemo.com

NORWAY / ICELAND

LEMO NORWAY A/S
Tel: +47 22 91 70 40
info-no@lemo.com

SINGAPORE

LEMO ASIA PTE LTD
Tel: +65 6476 0672
sg.sales@lemo.com

SPAIN / PORTUGAL

IBERLEMO SAU
Tel: +34 93 860 44 20
info-es@lemo.com

SWEDEN/FINLAND

LEMO NORDIC AB
Tel: +46 8 635 60 60
info-se@lemo.com

SWITZERLAND

LEMO VERKAUF AG
Tel: +41 41 790 49 40
ch.sales@lemo.com

TAIWAN

TAOYUAN TAIWAN
Tel: +886 967 132 824
speng@lemo.com

UNITED ARAB EMIRATES

LEMO MIDDLE EAST
CONNECTORS LLC
Tel: +971 4 568 1904
info-me@lemo.com

UNITED KINGDOM

LEMO UK LTD
Tel: +44 1903 23 45 43
lemouk@lemo.com

USA

LEMO USA INC
Tel: +1 707 578 88 11
info-us@lemo.com

USA

NORTHWIRE INC
Tel: +1 715 294 21 21
cableinfo_northwire@lemo.com

DISTRIBUTORS

ARGENTINA
AUSTRALIA
BRAZIL
CHILE

COLOMBIA / PERU
CZECH REPUBLIC
GREECE
INDIA

ISRAEL
NEW ZEALAND
POLAND
SOUTH AFRICA

SOUTH KOREA
TURKEY
UKRAINE

CATALOG ONLINE



WWW.LEMO.COM

X-ON Electronics

Largest Supplier of Electrical and Electronic Components

Click to view similar products for [Circular Push Pull Connectors](#) category:

Click to view products by [LEMO](#) manufacturer:

Other Similar products are found below :

[6407-249V-11273P](#) [6408-201V-13273](#) [6408-202V-13343](#) [6408-202V-17343](#) [D38999/20ZG35PN-LC](#) [D38999/20ZJ24SA](#)
[D38999/20ZJ61PA-LC](#) [FAG.2B.319.CYC](#) [FGA.1B.307.CYCD72Z](#) [FLS.01.250.DLAE24](#) [PFG.1B.308.CYZZ](#) [PKG.M0.6BL.LZ](#)
[PLC.M1.0SL.LA](#) [GMA.2B.045.DJ](#) [GMA.3B.090.DA](#) [PRG.M0.6GL.LC52GZ](#) [ABF.1S.250.NTA](#) [1332M107MS](#) [EAJ.1B.306.CWA](#) [1589430-](#)
[2](#) [ELF.00.250.NTL](#) [ERA.01.250.DLL](#) [BRD.0B.200.PCSG](#) [HVP.03.250.CLLPV](#) [CAH.M34.SLL.C72GZ](#) [CAJ.M34.SLL.C72GZ](#) [300500](#)
[EXG.0B.309.HLN](#) [FFB.1S.250.CLAC27](#) [FLC.00.250.CTAC31](#) [FPG.0B.305.CLAD52](#) [PCS.01.250.DLLE31](#) [PKC.M0.7GL.NG](#)
[PKG.M0.4TL.LZ](#) [PXG.M0.8GG.NG](#) [HEG.1B.307.CLNP](#) [BRR.3S.200.PZVG](#) [JDXEP2T19FSN](#) [400374](#) [DTA.99.700.5Z](#) [ECG.00.304.CLL](#)
[ECP.0S.304.CLN](#) [EEG.1B.306.CYZ](#) [MS3117-12BU](#) [EGA.00.303.CLL](#) [SAN.M13.GLA.6G](#) [6408-201V-11343](#) [6408-202V-25273](#)
[PAC.M0.4NL.AC52J](#) [980-0009-471](#)