

## SUMMARY

### # Wires

Low voltage 5



*Image is for illustrative purpose only*

Series 0F  
Termination type Female crimp  
IP rating 67  
AWG wire size 26.00 - 22.00  
Cable Ø 3.80 - 9.00 mm  
Status active  
Matching parts [FGN.OF.305.XLC](#)

### Download

[Request a quote](#)

[Catalog](#)

## TECHNICAL DETAILS

### Mechanics

Shell Style/Model EH\*: Fixed receptacle, nut fixing (back panel mounting, printed circuit mounting possible)  
Keying 3 keys (beta=165, gamma=30, plug: male contacts, receptacle: female contacts)  
Housing Material Aluminium (nickel plated [SAE AMS QQ N 290], anthracite color) shell and nut, other pieces bronze/brass  
Weight 4.48 g

### Performance

Configuration 0F.305 : 5 Low Voltage  
Insulator L: PEEK (UL 94 / V-0/1.5)  
Rated Current 6.5 Amps

### Specifications

Contact Type: Crimp  
Contact Retention: 22 N  
Contact Dia.: 0.7 mm (0.028in)  
Bucket Dia.: 0.8 mm (0.031in)  
Min. Conductor: 0.14 mm<sup>2</sup> (AWG 26)  
Max. Conductor: 0.34 mm<sup>2</sup> (AWG 22)  
R (max): 6.1 mOhm  
Vtest (contact-shell): 1200 V (AC), 1700 V (DC)

*LEMO products and services are provided "as is". LEMO makes no warranties or representations with regard to LEMO product & services or use of them, express, implied or statutory, including for accuracy, completeness, or security. The user is fully responsible for his products and applications using LEMO components.*

Vtest (contact-contact): 1250 V (AC), 1770 V (DC)

## Others

Endurance (Shell): 1000 mating cycles  
Temp (min / max): -15°C / +200°C  
Humidity (max): <=95% [at 60 deg C / 140 F]  
Vibration: 15 g [10 Hz - 2000 Hz]  
Shock Resistance: 100 g [ 6 ms]  
Climatical Category: 15/200/21 (Aluminium shell)  
Salt Spray Corrosion: max. 48 hr

## DRAWINGS

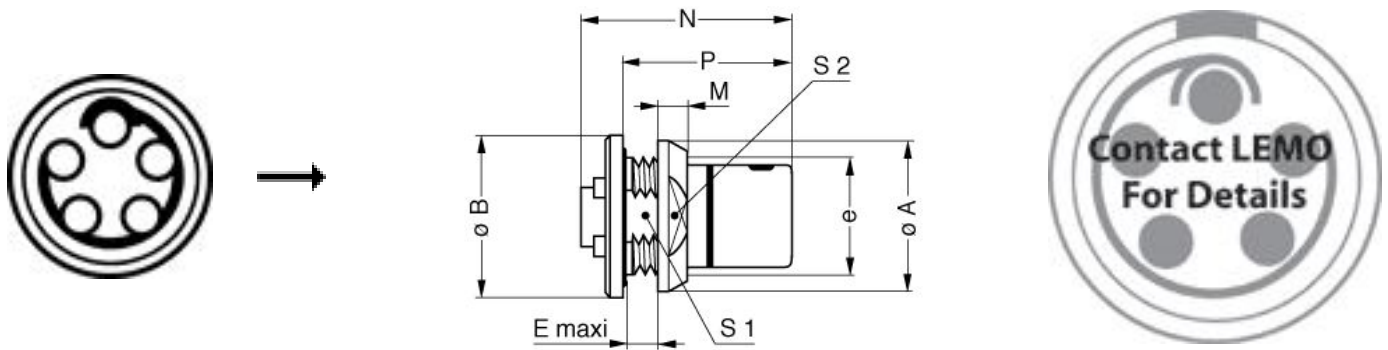

## Dimensions

	A	B	E	M	N	P	S1	S2	e
mm.	13	14	3	2.5	19	14.5	9	11	M10x0.75
in.	0,51	0,55	0,12	0,10	0,75	0,57	0,35	0,43	

## RECOMMENDED BY LEMO

### Tools









Crimp Tool: [DPC.91.701.V](#)

Crimp settings: AWG/Selector = 22-24-26/6-5-5

*LEMO products and services are provided "as is". LEMO makes no warranties or representations with regard to LEMO product & services or use of them, express, implied or statutory, including for accuracy, completeness, or security. The user is fully responsible for his products and applications using LEMO components.*

Positionner: [DCE.91.070.BVM](#)  
 Extractor: [DCF.93.070.4LT](#)  
 Replacement contact: EGG.0B.655.ZZM

## Cables

CMN.05.T22.051QGZE	TPR (medical)	Grey	
CMN.05.T28.029PGCE	PVC	GREY	
CMN.05.T28.029PGZE		Grey	
CMN.05.T28.029PNCE	PVC	Black	
CMN.05.T28.029PNZE			
150250	PVC	Grey	
50090	PVC	Black	
50140	PVC	Grey	
5050	PVC	Black	

*LEMO products and services are provided "as is". LEMO makes no warranties or representations with regard to LEMO product & services or use of them, express, implied or statutory, including for accuracy, completeness, or security. The user is fully responsible for his products and applications using LEMO components.*

## X-ON Electronics

Largest Supplier of Electrical and Electronic Components

*Click to view similar products for [Circular Push Pull Connectors](#) category:*

*Click to view products by [LEMO](#) manufacturer:*

Other Similar products are found below :

[6407-249V-11273P](#) [6408-201V-13273](#) [6408-202V-13343](#) [6408-202V-17343](#) [EZG.0B.309.CLN](#) [FFA.2S.310.ZLA](#) [FGA.1B.307.CYCD72Z](#)  
[FGJ.1B.304.CLLD76](#) [FGJ.1B.306.CWLD72](#) [FGJ.3B.304.CYMD10Z](#) [FGJ.3B.304.CYMD82Z](#) [FHG.1B.303.CYCZ](#) [PCS.01.250.DLLE24](#)  
[PHG.0K.305.CYMC40Z](#) [PHG.1K.308.CLLK85](#) [PKG.M0.6BL.LZ](#) [PLC.M1.0SL.LA](#) [GMA.10.290.DN](#) [GMA.3B.090.DA](#)  
[PRG.M0.6GL.LC52GZ](#) [PSA.1S.275.CTLC66](#) [ABF.1S.250.NTA](#) [133020F](#) [1331ER193MZ](#) [1332M107MZ](#) [DTS26Z19-32JA-LC](#) [DTS26Z19-](#)  
[32SA](#) [DTS26Z19-32SA-LC](#) [EAJ.1B.306.CWA](#) [ECG.XB.312.CLL](#) [1589430-2](#) [EEA.0B.305.CLN](#) [EEA.0B.309.CLL](#) [ELF.00.250.NTL](#)  
[ERA.01.250.DLL](#) [BRR.2S.200.PZVG](#) [HR10A-P](#) [CAH.M34.SLL.C72GZ](#) [CAJ.M34.SLL.C72GZ](#) [300500](#) [ESB.00.303.NLL](#)  
[EXG.0B.309.HLN](#) [FFB.1S.250.CLAC27](#) [FGA.2B.306.CYCD92](#) [FGA.2B.306.CYCD92Z](#) [FGJ.1B.302.CYMD62](#) [FGJ.3B.308.CLLD72Z](#)  
[FHG.1B.303.CYCD62](#) [FLC.00.250.CTAC31](#) [PCS.01.250.DLLE31](#)