

## SUMMARY



Image is for illustrative purpose only

### # Wires

Coax 1

Series 0A  
Termination type Female solder  
IP rating 50  
AWG wire size 0.00 - 0.00  
Cable Ø 0.00 - 0.00 mm  
Status active

### Download

[Request a quote](#)

[Catalog](#)

## TECHNICAL DETAILS

### Mechanics

Shell Style/Model ERN\*: Fixed receptacle with tag, nut fixing

#### Keying

Housing Material Brass (nickel plated [SAE AMS QQ N 290]) shell, collet nut, latch sleeve and mid pieces

Weight 4.33 g

### Performance

Configuration 0A.250 : 1 Coax (50 Ohm)

#### Insulator

#### Rated Current

### Specifications

Contact Type: Coaxial 50 Ohm (Solder)

### Others

Endurance (Shell): 5000 mating cycles

Salt Spray Corrosion: >144 hr

LEMO products and services are provided "as is". LEMO makes no warranties or representations with regard to LEMO product & services or use of them, express, implied or statutory, including for accuracy, completeness, or security. The user is fully responsible for his products and applications using LEMO components.

# DRAWINGS

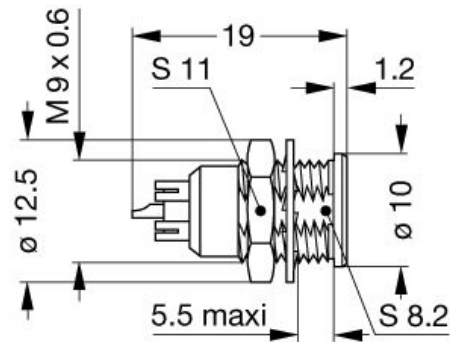





## Dimensions

|     | A    | B    | E <sub>max</sub> | L    | M    | S1   | S2   | e1     |
|-----|------|------|------------------|------|------|------|------|--------|
| mm. | 10   | 12.5 | 5.5              | 19   | 1.2  | 8.2  | 11   | M9x0.6 |
| in. | 0,39 | 0,49 | 0,22             | 0,75 | 0,05 | 0,32 | 0,43 |        |



# RECOMMENDED BY LEMO

## Tools

## Cables

|        |           |       |  |
|--------|-----------|-------|--|
| 158480 | PUR       | Black |  |
| 158490 | PVC       | Black |  |
| 159580 | PVC       | Black |  |
| 17420  | PVC       | Black |  |
| 17450  | COPOLYMER | Black |  |
| 178190 | PTFE      | Brown |  |
| 18000  | PTFE      | Brown |  |
| 18700  | PTFE      | White |  |
| 18800  | PTFE      | White |  |
| 196270 | PTFE      | White |  |

LEMO products and services are provided "as is". LEMO makes no warranties or representations with regard to LEMO product & services or use of them, express, implied or statutory, including for accuracy, completeness, or security. The user is fully responsible for his products and applications using LEMO components.

|                     |      |        |  |
|---------------------|------|--------|--|
| 31600               | PTFE | Brown  |  |
| 62000               | PVC  | Black  |  |
| CCX.50.030.083.180B |      | White  |  |
| CCX.50.080.297538N  | PVC  | Black  |  |
| CCX.50.088.292495N  | PVC  | Black  |  |
| CCX.50.RG0.58AU14B  | FEP  | White  |  |
| CCX.50.RG0.58AU61J  | PVC  | Yellow |  |
| CCX.50.RG1.74-U25N  | PVC  | Black  |  |
| CCX.50.RG1.74AU28N  | PVC  | Black  |  |
| CCX.50.RG1.74AU28N  | PVC  | Black  |    |
| CCX.50.RG1.74U25N   | PVC  | Black  |  |
| CCX.50.RG1.78BU18M  | FEP  | Brown  |  |
| CCX.50.RG1.78BU18M  | PTFE | Brown  |  |
| CCX.50.RG1.88AU24B  | TFE  | White  |  |
| CCX.50.RG1.88AU26B  | PFA  | White  |  |
| CCX.50.RG1.88AU26B  | PTFE | White  |  |
| CCX.50.RG1.96AU19B  | PTFE | White  |  |
| CCX.50.RG1.96AU20B  | PFA  | White  |  |
| CCX.50.RG3.16BU26M  | FEP  | Brown  |  |
| CCX.50.RG3.16U28M   | PTFE | Brown  |  |
| CCX.50.RG5.8CU50N   | PVC  | Black  |  |
| CCX.75.040.195327G  | PVC  | Grey   |  |
| CCX.75.RG0.59BU62N  | PVC  | Black  |  |
| CCX.75.RG1.79BU26M  | FEP  | Brown  |  |
| CCX.75.RG1.87AU26B  | PFA  | White  |  |
| CCX.75.RG1.87AU27B  | PTFE | White  |  |
| CCX.93.RG0.62AU62N  | PVC  | Black  |  |
| CCX.95.RG1.80BU36M  | PTFE | Brown  |  |
| CCX.95.RG1.95AU37B  | PFA  | White  |  |

LEMO products and services are provided "as is". LEMO makes no warranties or representations with regard to LEMO product & services or use of them, express, implied or statutory, including for accuracy, completeness, or security. The user is fully responsible for his products and applications using LEMO components.

## X-ON Electronics

Largest Supplier of Electrical and Electronic Components

*Click to view similar products for [Circular Push Pull Connectors](#) category:*

*Click to view products by [LEMO](#) manufacturer:*

Other Similar products are found below :

[6407-249V-11273P](#) [6408-201V-13273](#) [6408-202V-13343](#) [6408-202V-17343](#) [EZG.0B.309.CLN](#) [FFA.2S.310.ZLA](#) [FGA.1B.307.CYCD72Z](#)  
[FGJ.1B.304.CLLD76](#) [FGJ.1B.306.CWLD72](#) [FGJ.3B.304.CYMD10Z](#) [FGJ.3B.304.CYMD82Z](#) [PCS.01.250.DLLE24](#) [PHG.0K.305.CYMC40Z](#)  
[PHG.1K.308.CLLK85](#) [PKG.M0.6BL.LZ](#) [PLC.M1.0SL.LA](#) [GMA.10.290.DN](#) [GMA.3B.090.DA](#) [PRG.M0.6GL.LC52GZ](#) [PSA.1S.275.CTLC66](#)  
[ABF.1S.250.NTA](#) [133020F](#) [1331ER193MZ](#) [1332M107MZ](#) [DTS26Z19-32JA-LC](#) [DTS26Z19-32SA](#) [DTS26Z19-32SA-LC](#) [DTS26Z23-55HA](#)  
[DTS26Z23-55HA-LC](#) [DTS26Z23-55JA-LC](#) [EAJ.1B.306.CWA](#) [ECG.XB.312.CLL](#) [1589430-2](#) [EEA.0B.305.CLN](#) [EEA.0B.309.CLL](#)  
[ELF.00.250.NTL](#) [ERA.01.250.DLL](#) [BRR.2S.200.PZVG](#) [HR10A-P](#) [CAH.M34.SLL.C72GZ](#) [CAJ.M34.SLL.C72GZ](#) [300500](#) [ESB.00.303.NLL](#)  
[EXG.0B.309.HLN](#) [FFB.1S.250.CLAC27](#) [FGA.2B.306.CYCD92](#) [FGA.2B.306.CYCD92Z](#) [FGA.XB.312.CLAD72](#) [FGJ.1B.302.CYMD62](#)  
[FGJ.3B.308.CLLD72Z](#)