

## SUMMARY

### # Wires

Low voltage 10

Series 2S  
Termination type Male solder  
IP rating 50  
AWG wire size 30.00 - 22.00  
Cable Ø 0.00 - 0.00 mm  
Status active  
Matching parts [PCA.2S.310.CLLC32Z](#)

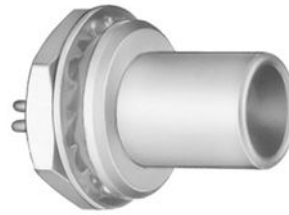

Image is for illustrative purpose only

### Download

[Request a quote](#)

[Catalog](#)

## TECHNICAL DETAILS

### Mechanics

Shell Style/Model FAA\*: Fixed plug, non-latching, nut fixing  
Keying Hermaphroditic keying (half moon insert) with male pin 1  
Housing Material Brass (chrome plated [SAE AMS 2460]) shell and collet nut, nickel plated [SAE AMS QQ N 290] brass latch sleeve and mid pieces  
Weight 15.93 g

### Performance

Configuration 2S.310 : 10 Low Voltage  
Insulator L: PEEK (UL 94 / V-0/1.5)  
Rated Current 7 Amps

### Specifications

Contact Type: Solder  
Contact Dia.: 0.9 mm (0.0354in)  
Bucket Dia.: 0.8 mm (0.031in)  
Max. Solid Conductor: 0.34 mm<sup>2</sup> (AWG 22)  
R (max): 4.8 mOhm  
Vtest: 800 V (AC), 1200 V (DC)

### Others

LEMO products and services are provided "as is". LEMO makes no warranties or representations with regard to LEMO product & services or use of them, express, implied or statutory, including for accuracy, completeness, or security. The user is fully responsible for his products and applications using LEMO components.

Endurance (Shell): 5000 mating cycles  
 Temp (min / max): -55°C / +250°C  
 Humidity (max): <=95% [at 60 deg C / 140 F]  
 Vibration: 15 g [10 Hz - 2000 Hz]  
 Shock Resistance: 100 g [ 6 ms]  
 Climatical Category: 50/175/21  
 Shielding (min): 75 dB (10 MHz)  
 Shielding (min): 40 dB (1 GHz)  
 Salt Spray Corrosion: >144 hr

## DRAWINGS

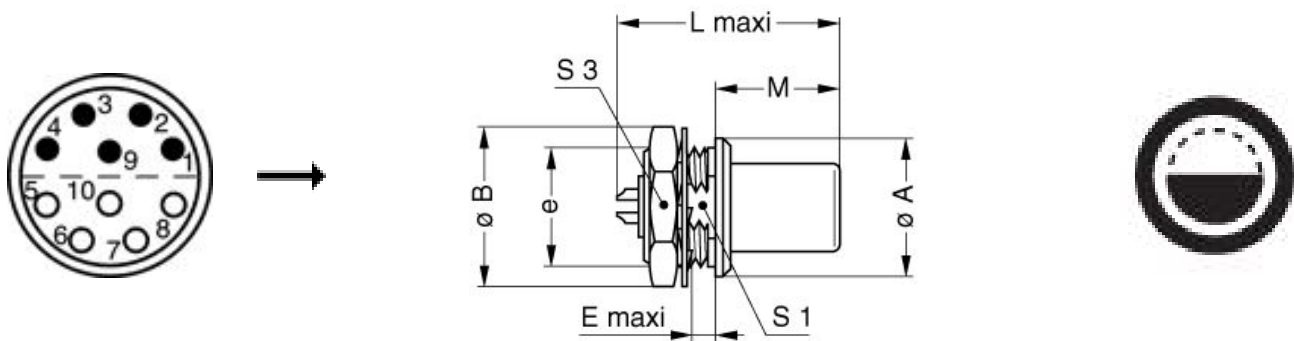

### Dimensions













	A	A	B	E	L	M	S1	S3	e
mm.	18	18	19.5	4	25	13.8	13.5	17	M15x1.0
in.	0,71	0,71	0,77	0,16	0,98	0,54	0,53	0,67	

## RECOMMENDED BY LEMO

### Tools

### Cables

LEMO products and services are provided "as is". LEMO makes no warranties or representations with regard to LEMO product & services or use of them, express, implied or statutory, including for accuracy, completeness, or security. The user is fully responsible for his products and applications using LEMO components.

CMN.10.T22.068QGZE	TPR (medical)	Grey	
CMN.10.T28.052PGZE		Grey	
CMN.10.T28.052PNZE			
CMN.10.T28.053QGZE	TPR (medical)	Grey	
110220	PVC	Black	
110240	PTFE	White	
110260	PTFE	White	
110280	PVC	Black	
210140	PVC	Grey	
210240	PVC	Black	
210250	PVC	Grey	
210260	PVC	Black	

LEMO products and services are provided "as is". LEMO makes no warranties or representations with regard to LEMO product & services or use of them, express, implied or statutory, including for accuracy, completeness, or security. The user is fully responsible for his products and applications using LEMO components.

## X-ON Electronics

Largest Supplier of Electrical and Electronic Components

*Click to view similar products for [Circular Push Pull Connectors](#) category:*

*Click to view products by [LEMO](#) manufacturer:*

Other Similar products are found below :

[6407-249V-11273P](#) [6408-201V-13273](#) [6408-202V-13343](#) [6408-202V-17343](#) [EZG.0B.309.CLN](#) [FFA.2S.310.ZLA](#) [FGA.1B.307.CYCD72Z](#)  
[FGJ.1B.304.CLLD76](#) [FGJ.1B.306.CWLD72](#) [FGJ.3B.304.CYMD10Z](#) [FGJ.3B.304.CYMD82Z](#) [PCS.01.250.DLLE24](#) [PHG.0K.305.CYMC40Z](#)  
[PHG.1K.308.CLLK85](#) [PKG.M0.6BL.LZ](#) [PLC.M1.0SL.LA](#) [GMA.10.290.DN](#) [GMA.3B.090.DA](#) [PRG.M0.6GL.LC52GZ](#) [PSA.1S.275.CTLC66](#)  
[ABF.1S.250.NTA](#) [133020F](#) [1331ER193MZ](#) [1332M107MZ](#) [DTS26Z19-32JA-LC](#) [DTS26Z19-32SA](#) [DTS26Z19-32SA-LC](#) [DTS26Z23-55HA](#)  
[DTS26Z23-55HA-LC](#) [DTS26Z23-55JA-LC](#) [EAJ.1B.306.CWA](#) [ECG.XB.312.CLL](#) [1589430-2](#) [EEA.0B.305.CLN](#) [EEA.0B.309.CLL](#)  
[ELF.00.250.NTL](#) [ERA.01.250.DLL](#) [BRR.2S.200.PZVG](#) [HR10A-P](#) [CAH.M34.SLL.C72GZ](#) [CAJ.M34.SLL.C72GZ](#) [300500](#) [ESB.00.303.NLL](#)  
[EXG.0B.309.HLN](#) [FFB.1S.250.CLAC27](#) [FGA.2B.306.CYCD92](#) [FGA.2B.306.CYCD92Z](#) [FGA.XB.312.CLAD72](#) [FGJ.1B.302.CYMD62](#)  
[FGJ.3B.308.CLLD72Z](#)