

## SUMMARY

### # Wires

Low voltage 12

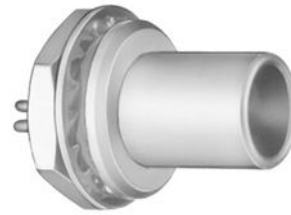

Image is for illustrative purpose only

Series 4S  
Termination type Male solder  
IP rating 50  
AWG wire size 28.00 - 20.00  
Cable Ø 0.00 - 0.00 mm  
Status active

### Download

[Request a quote](#)

[Catalog](#)

## TECHNICAL DETAILS

### Mechanics

Shell Style/Model FAA\*: Fixed plug, non-latching, nut fixing  
Keying Hermaphroditic keying (half moon insert) with male pin 1  
Housing Material Brass (chrome plated [SAE AMS 2460]) shell and collet nut, nickel plated [SAE AMS QQ N 290] brass latch sleeve and mid pieces  
Weight 67.14 g

### Performance

Configuration 4S.312 : 12 Low Voltage  
Insulator L: PEEK (UL 94 / V-0/1.5)  
Rated Current 9 Amps

### Specifications

Contact Type: Solder  
Contact Dia.: 1.3 mm (0.051in)  
Bucket Dia.: 1 mm (0.039in)  
Max. Solid Conductor: 0.5 mm<sup>2</sup> (AWG 20)  
Max. Stranded Conductor: 0.5 mm<sup>2</sup> (AWG 20)  
R (max): 3.6 mOhm  
Vtest: 2100 V (AC), 3000 V (DC)

LEMO products and services are provided "as is". LEMO makes no warranties or representations with regard to LEMO product & services or use of them, express, implied or statutory, including for accuracy, completeness, or security. The user is fully responsible for his products and applications using LEMO components.

## Others

Endurance (Shell): 5000 mating cycles  
Temp (min / max): -55°C / +250°C  
Humidity (max): <=95% [at 60 deg C / 140 F]  
Vibration: 15 g [10 Hz - 2000 Hz]  
Shock Resistance: 100 g [ 6 ms]  
Climatical Category: 50/175/21  
Shielding (min): 75 dB (10 MHz)  
Shielding (min): 40 dB (1 GHz)  
Salt Spray Corrosion: >144 hr

## DRAWINGS

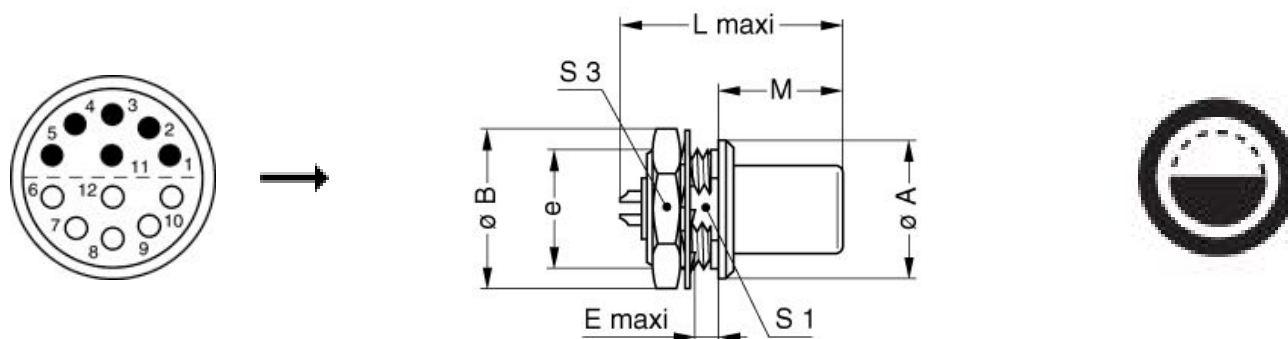

## Dimensions

	A	B	E	L	M	S1	S3	e
mm.	28	32	2.5	35.5	20.5	23.5	30	M25x1.0
in.	1,10	1,26	0,10	1,40	0,81	0,93	1,18	













## RECOMMENDED BY LEMO

### Tools

Caps: [BFA.4S.100.NAS](#)

*LEMO products and services are provided "as is". LEMO makes no warranties or representations with regard to LEMO product & services or use of them, express, implied or statutory, including for accuracy, completeness, or security. The user is fully responsible for his products and applications using LEMO components.*

## Cables

CMN.12.T22.070QGZE	TPR (medical)	Grey	
CMN.12.T28.054PGZE		Grey	
CMN.12.T28.054PNZE			
112240	PTFE	White	
112260	PTFE	White	
112280	PVC	Black	
12050	PVC	Black	
124080	PVC	Grey	
124084	PVC	Black	
212220	PVC	Black	
212240	PVC	Black	
212250	PVC	Grey	
212260	PVC	Black	
412500	PVC	Grey	
412750	PVC	Grey	

LEMO products and services are provided "as is". LEMO makes no warranties or representations with regard to LEMO product & services or use of them, express, implied or statutory, including for accuracy, completeness, or security. The user is fully responsible for his products and applications using LEMO components.

## X-ON Electronics

Largest Supplier of Electrical and Electronic Components

*Click to view similar products for [Circular Push Pull Connectors](#) category:*

*Click to view products by [LEMO](#) manufacturer:*

Other Similar products are found below :

[6407-249V-11273P](#) [6408-201V-13273](#) [6408-202V-13343](#) [6408-202V-17343](#) [EZG.0B.309.CLN](#) [FFA.2S.310.ZLA](#) [FGA.1B.307.CYCD72Z](#)  
[FGJ.1B.304.CLLD76](#) [FGJ.1B.306.CWLD72](#) [FGJ.3B.304.CYMD10Z](#) [FGJ.3B.304.CYMD82Z](#) [PCS.01.250.DLLE24](#) [PHG.0K.305.CYMC40Z](#)  
[PHG.1K.308.CLLK85](#) [PKG.M0.6BL.LZ](#) [PLC.M1.0SL.LA](#) [GMA.10.290.DN](#) [GMA.3B.090.DA](#) [PRG.M0.6GL.LC52GZ](#) [PSA.1S.275.CTLC66](#)  
[ABF.1S.250.NTA](#) [133020F](#) [1331ER193MZ](#) [1332M107MZ](#) [DTS26Z19-32JA-LC](#) [DTS26Z19-32SA](#) [DTS26Z19-32SA-LC](#) [DTS26Z23-55HA](#)  
[DTS26Z23-55HA-LC](#) [DTS26Z23-55JA-LC](#) [EAJ.1B.306.CWA](#) [ECG.XB.312.CLL](#) [1589430-2](#) [EEA.0B.305.CLN](#) [EEA.0B.309.CLL](#)  
[ELF.00.250.NTL](#) [ERA.01.250.DLL](#) [BRR.2S.200.PZVG](#) [HR10A-P](#) [CAH.M34.SLL.C72GZ](#) [CAJ.M34.SLL.C72GZ](#) [300500](#) [ESB.00.303.NLL](#)  
[EXG.0B.309.HLN](#) [FFB.1S.250.CLAC27](#) [FGA.2B.306.CYCD92](#) [FGA.2B.306.CYCD92Z](#) [FGA.XB.312.CLAD72](#) [FGJ.1B.302.CYMD62](#)  
[FGJ.3B.308.CLLD72Z](#)