

## SUMMARY

### # Wires

Low voltage 8



Image is for illustrative purpose only

Series 3S  
Termination type Male solder  
IP rating 50  
AWG wire size 28.00 - 20.00  
Cable Ø 5.80 - 7.20 mm  
Status active  
Matching parts [ERA.3S.308.CLL](#)

### Download

[Request a quote](#)

[Catalog](#)

## TECHNICAL DETAILS

### Mechanics

Shell Style/Model FFP\*: Straight plug, cable collet and inner anti-rotating device  
Keying Hermaphroditic keying (half moon insert) with male pin 1  
Housing Material Brass (chrome plated [SAE AMS 2460]) shell and collet nut, nickel plated [SAE AMS QQ N 290] brass latch sleeve and mid pieces  
Weight 55.29 g

### Performance

Configuration 3S.308 : 8 Low Voltage  
Insulator L: PEEK (UL 94 / V-0/1.5)  
Rated Current 10 Amps

### Specifications

Contact Type: Solder  
Contact Dia.: 1.3 mm (0.051in)  
Bucket Dia.: 1 mm (0.039in)  
Max. Solid Conductor: 0.5 mm<sup>2</sup> (AWG 20)  
Max. Stranded Conductor: 0.5 mm<sup>2</sup> (AWG 20)  
R (max): 3.6 mOhm  
Vtest: 1060 V (AC), 1500 V (DC)

LEMO products and services are provided "as is". LEMO makes no warranties or representations with regard to LEMO product & services or use of them, express, implied or statutory, including for accuracy, completeness, or security. The user is fully responsible for his products and applications using LEMO components.

## Others

Endurance (Shell): 5000 mating cycles  
Temp (min / max): -55°C / +250°C  
Humidity (max): <=95% [at 60 deg C / 140 F]  
Vibration: 15 g [10 Hz - 2000 Hz]  
Shock Resistance: 100 g [ 6 ms]  
Climatical Category: 50/175/21  
Shielding (min): 75 dB (10 MHz)  
Shielding (min): 40 dB (1 GHz)  
Salt Spray Corrosion: >144 hr

## DRAWINGS

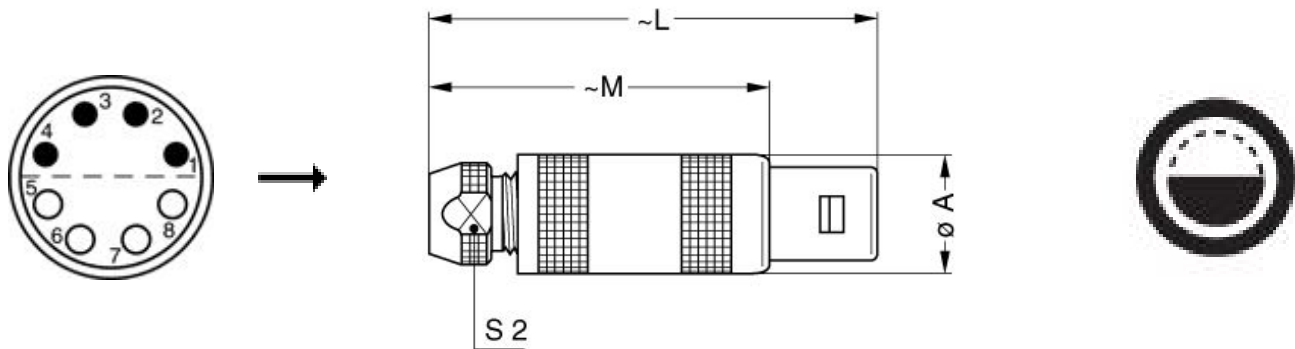

## Dimensions

	A	L	M	S2
mm.	17.8	61	46	14
in.	0,70	2,40	1,81	0,55









## RECOMMENDED BY LEMO

### Tools

Spanner wrench: [DCP.91.023.TN](#)

*LEMO products and services are provided "as is". LEMO makes no warranties or representations with regard to LEMO product & services or use of them, express, implied or statutory, including for accuracy, completeness, or security. The user is fully responsible for his products and applications using LEMO components.*

## Cables

CMN.08.T20.067PGCE	PVC	Grey	
CMN.08.T20.067PGZE		Grey	
CMN.08.T20.067PNZE			
CMN.08.T22.059QGC	TPR	Grey	
CMN.08.T22.059QGZE	TPR (medical)	Grey	
108220	PVC	Black	
16080	PVC	Grey	
180240	PVC	Black	
280250	PVC	Grey	
335990	PVC	Black	
335991	PVC	Black	
42265	PVC	Yellow	

LEMO products and services are provided "as is". LEMO makes no warranties or representations with regard to LEMO product & services or use of them, express, implied or statutory, including for accuracy, completeness, or security. The user is fully responsible for his products and applications using LEMO components.

## X-ON Electronics

Largest Supplier of Electrical and Electronic Components

*Click to view similar products for [Circular Push Pull Connectors](#) category:*

*Click to view products by [LEMO](#) manufacturer:*

Other Similar products are found below :

[6407-249V-11273P](#) [6408-201V-13273](#) [6408-202V-13343](#) [6408-202V-17343](#) [EZG.0B.309.CLN](#) [FFA.2S.310.ZLA](#) [FGA.1B.307.CYCD72Z](#)  
[FGJ.1B.304.CLLD76](#) [FGJ.1B.306.CWLD72](#) [FGJ.3B.304.CYMD10Z](#) [FGJ.3B.304.CYMD82Z](#) [PCS.01.250.DLLE24](#) [PHG.0K.305.CYMC40Z](#)  
[PHG.1K.308.CLLK85](#) [PKG.M0.6BL.LZ](#) [PLC.M1.0SL.LA](#) [GMA.10.290.DN](#) [GMA.3B.090.DA](#) [PRG.M0.6GL.LC52GZ](#) [PSA.1S.275.CTLC66](#)  
[ABF.1S.250.NTA](#) [133020F](#) [1331ER193MZ](#) [1332M107MZ](#) [DTS26Z19-32JA-LC](#) [DTS26Z19-32SA](#) [DTS26Z19-32SA-LC](#) [DTS26Z23-55HA](#)  
[DTS26Z23-55HA-LC](#) [DTS26Z23-55JA-LC](#) [EAJ.1B.306.CWA](#) [ECG.XB.312.CLL](#) [1589430-2](#) [EEA.0B.305.CLN](#) [EEA.0B.309.CLL](#)  
[ELF.00.250.NTL](#) [ERA.01.250.DLL](#) [BRR.2S.200.PZVG](#) [HR10A-P](#) [CAH.M34.SLL.C72GZ](#) [CAJ.M34.SLL.C72GZ](#) [300500](#) [ESB.00.303.NLL](#)  
[EXG.0B.309.HLN](#) [FFB.1S.250.CLAC27](#) [FGA.2B.306.CYCD92](#) [FGA.2B.306.CYCD92Z](#) [FGA.XB.312.CLAD72](#) [FGJ.1B.302.CYMD62](#)  
[FGJ.3B.308.CLLD72Z](#)