

## SUMMARY

### # Wires

Low voltage 4



*Image is for illustrative purpose only*

Series 1B  
Termination type Male crimp  
IP rating 50  
AWG wire size 24.00 - 20.00  
Cable Ø 4.30 - 5.20 mm  
Status active  
Matching parts [EGB.1B.304.CYM](#)

### Download

[Request a quote](#)  
[Catalog](#)  
[See video assembly instructions](#)

## TECHNICAL DETAILS

### Mechanics

Shell Style/Model FG\*: Straight plug, cable collet and nut for fitting a bend relief  
Keying 2 keys (alpha=60, plug: male contacts, receptacle: female contacts)  
Housing Material Brass (chrome plated [SAE AMS 2460]) shell and collet nut, nickel plated [SAE AMS QQ N 290] brass latch sleeve and mid pieces  
Variant Z : Nut for fitting a bend relief

### Performance

Configuration 1B.304 : 4 Low Voltage  
Insulator Y: PEEK for crimp contacts  
Rated Current 10 Amps

### Specifications

Contact Type: Crimp  
Contact Retention: 30 N  
Contact Dia.: 0.9 mm (0.035in)  
Bucket Dia.: 1.1 mm (0.043in)  
Min. Conductor: 0.25 mm<sup>2</sup> (AWG 24)  
Max. Conductor: 0.5 mm<sup>2</sup> (AWG 20)  
R (max): 4.8 mOhm  
Vtest (contact-shell): 1800 V (AC), 2550 V (DC)

*LEMO products and services are provided "as is". LEMO makes no warranties or representations with regard to LEMO product & services or use of them, express, implied or statutory, including for accuracy, completeness, or security. The user is fully responsible for his products and applications using LEMO components.*

Vtest (contact-contact): 1700 V (AC), 2400 V (DC)

## Others

Endurance (Shell): 5000  
Temp (min / max): -55°C / +250°C  
Humidity (max): ≤95% [at 60 deg C / 140 F]  
Vibration: 15 g [10 Hz - 2000 Hz]  
Shock Resistance: 100 g [ 6 ms]  
Climatical Category: 50/175/21  
Shielding (min): 75 dB (10 MHz)  
Shielding (min): 40 dB (1 GHz)  
Salt Spray Corrosion: >1000 hr

## DRAWINGS

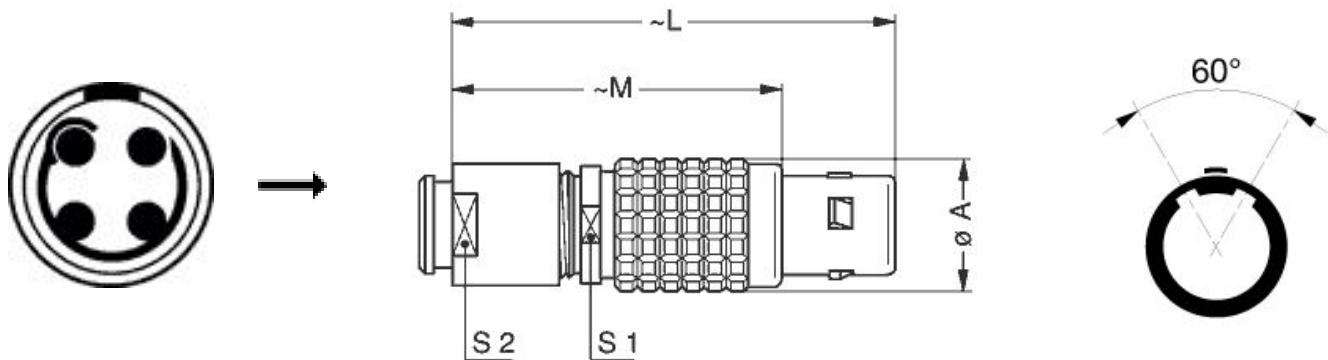

## Dimensions

	A	L	M	S1	S2
mm.	12	42	31	10	9
in.	0,47	1,65	1,22	0,39	0,35







## RECOMMENDED BY LEMO

### Tools

LEMO products and services are provided "as is". LEMO makes no warranties or representations with regard to LEMO product & services or use of them, express, implied or statutory, including for accuracy, completeness, or security. The user is fully responsible for his products and applications using LEMO components.

Crimp Tool: [DPC.91.701.V](#)  
 Crimp settings: AWG/Selector = 20-22-24/6-5-5  
 Positionner: [DCE.91.091.BVC](#)  
 Extractor: [DCF.91.090.2LT](#)  
 Replacement contact: FGG.1B.560.ZZC  
 Spanner wrench: [DCD.1B.015.PA090](#)

## Cables

CMN.04.T22.047QGC	TPR	Grey	
CMN.04.T22.048QGZE	TPR (medical)	Grey	
140240	PVC	Black	
140250	PVC	Grey	
40260	PVC	Black	
4080	PVC	Grey	
4221	PVC	Black	
4280	PVC	Black	
80080	PVC	Grey	
80082	PVC	Red	
80084	PVC	Black	

*LEMO products and services are provided "as is". LEMO makes no warranties or representations with regard to LEMO product & services or use of them, express, implied or statutory, including for accuracy, completeness, or security. The user is fully responsible for his products and applications using LEMO components.*

## X-ON Electronics

Largest Supplier of Electrical and Electronic Components

*Click to view similar products for [Circular Push Pull Connectors](#) category:*

*Click to view products by [LEMO](#) manufacturer:*

Other Similar products are found below :

[6407-249V-11273P](#) [6408-201V-13273](#) [6408-202V-13343](#) [6408-202V-17343](#) [EZG.0B.309.CLN](#) [FFA.2S.310.ZLA](#) [FGA.1B.307.CYCD72Z](#)  
[FGJ.1B.304.CLLD76](#) [FGJ.1B.306.CWLD72](#) [FGJ.3B.304.CYMD10Z](#) [FGJ.3B.304.CYMD82Z](#) [PCS.01.250.DLLE24](#) [PHG.0K.305.CYMC40Z](#)  
[PHG.1K.308.CLLK85](#) [PKG.M0.6BL.LZ](#) [PLC.M1.0SL.LA](#) [GMA.10.290.DN](#) [GMA.3B.090.DA](#) [PRG.M0.6GL.LC52GZ](#) [PSA.1S.275.CTLC66](#)  
[ABF.1S.250.NTA](#) [133020F](#) [1331ER193MZ](#) [1332M107MZ](#) [DTS26Z19-32JA-LC](#) [DTS26Z19-32SA](#) [DTS26Z19-32SA-LC](#) [DTS26Z23-55HA](#)  
[DTS26Z23-55HA-LC](#) [DTS26Z23-55JA-LC](#) [EAJ.1B.306.CWA](#) [ECG.XB.312.CLL](#) [1589430-2](#) [EEA.0B.305.CLN](#) [EEA.0B.309.CLL](#)  
[ELF.00.250.NTL](#) [ERA.01.250.DLL](#) [BRR.2S.200.PZVG](#) [HR10A-P](#) [CAH.M34.SLL.C72GZ](#) [CAJ.M34.SLL.C72GZ](#) [300500](#) [ESB.00.303.NLL](#)  
[EXG.0B.309.HLN](#) [FFB.1S.250.CLAC27](#) [FGA.2B.306.CYCD92](#) [FGA.2B.306.CYCD92Z](#) [FGA.XB.312.CLAD72](#) [FGJ.1B.302.CYMD62](#)  
[FGJ.3B.308.CLLD72Z](#)