

## SUMMARY

### # Wires

Low voltage 3



*Image is for illustrative purpose only*

Series 0B  
Termination type Male solder  
IP rating 50  
AWG wire size 28.00 - 20.00  
Cable Ø 2.30 - 3.20 mm  
Status active  
Matching parts [EGG.0B.303.CLL](#)  
[PHG.0B.303.CLLD32](#)

### Download

[Request a quote](#)  
[Eplan](#)  
[Catalog](#)  
[See video assembly instructions](#)

## TECHNICAL DETAILS

### Mechanics

Shell Style/Model FG\*: Straight plug, cable collet  
Keying 1 key (alpha=0, plug: male contacts, receptacle: female contacts)  
Housing Material Brass (chrome plated [SAE AMS 2460]) shell and collet nut, nickel plated [SAE AMS QQ N 290] brass latch sleeve and mid pieces  
Weight 8.53 g

### Performance

Configuration 0B.303 : 3 Low Voltage  
Insulator L: PEEK (UL 94 / V-0/1.5)  
Rated Current 8 Amps

### Specifications

Contact Type: Solder  
Contact Dia.: 0.9 mm (0.035in)  
Bucket Dia.: 1.0 mm (0.039in)  
Max. Solid Conductor: 0.56 mm<sup>2</sup> (AWG 20)  
Max. Stranded Conductor: 0.56 mm<sup>2</sup> (AWG 20)  
R (max): 4.8 mOhm  
Vtest (contact-shell): 900 V (AC), 1270 V (DC)  
Vtest (contact-contact): 1200 V (AC), 1700 V (DC)

*LEMO products and services are provided "as is". LEMO makes no warranties or representations with regard to LEMO product & services or use of them, express, implied or statutory, including for accuracy, completeness, or security. The user is fully responsible for his products and applications using LEMO components.*

## Others

Endurance (Shell): 5000  
Temp (min / max): -55° C / +250° C  
Humidity (max): <=95% [at 60 deg C / 140 F]  
Vibration: 15 g [10 Hz - 2000 Hz]  
Shock Resistance: 100 g [ 6 ms]  
Climatical Category: 50/175/21  
Shielding (min): 75 dB (10 MHz)  
Shielding (min): 40 dB (1 GHz)  
Salt Spray Corrosion: >1000 hr

## DRAWINGS

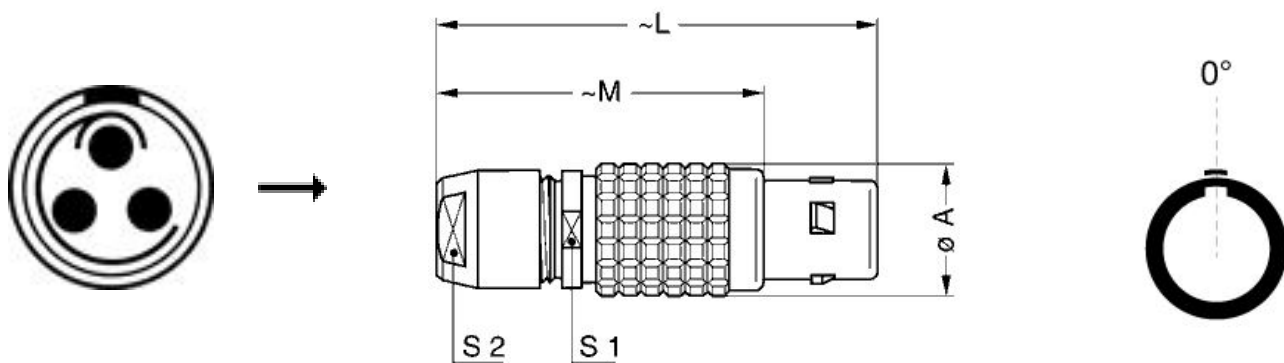

## Dimensions

	A	L	M	S1	S2
mm.	9.5	36	26	8	7
in.	0,37	1,42	1,02	0,31	0,28

## RECOMMENDED BY LEMO







### Tools

Spanner wrench: [DCD.0B.005.PA070](#)

Caps: [BFG.0B.100.PCSG](#)

*LEMO products and services are provided "as is". LEMO makes no warranties or representations with regard to LEMO product & services or use of them, express, implied or statutory, including for accuracy, completeness, or security. The user is fully responsible for his products and applications using LEMO components.*

## Cables

CMN.03.T28.031PGCE	PVC	GREY	
CMN.03.T28.031PGZE		Grey	
CMN.03.T28.031PNCE	PVC	Black	
CMN.03.T28.031PNZE			
30141	PVC	Grey	
3041	PVC	Grey	
3050	PVC	Black	
3081	PVC	Black	

LEMO products and services are provided "as is". LEMO makes no warranties or representations with regard to LEMO product & services or use of them, express, implied or statutory, including for accuracy, completeness, or security. The user is fully responsible for his products and applications using LEMO components.

## X-ON Electronics

Largest Supplier of Electrical and Electronic Components

*Click to view similar products for [Circular Push Pull Connectors](#) category:*

*Click to view products by [LEMO](#) manufacturer:*

Other Similar products are found below :

[6407-249V-11273P](#) [6408-201V-13273](#) [6408-202V-13343](#) [6408-202V-17343](#) [D38999/20ZG35PN-LC](#) [D38999/20ZJ24SA](#)  
[D38999/20ZJ61PA-LC](#) [FAG.2B.319.CYC](#) [FGA.1B.307.CYCD72Z](#) [FLS.01.250.DLAE24](#) [PFG.1B.308.CYZZ](#) [PKG.M0.6BL.LZ](#)  
[PLC.M1.0SL.LA](#) [GMA.2B.045.DJ](#) [GMA.3B.090.DA](#) [PRG.M0.6GL.LC52GZ](#) [ABF.1S.250.NTA](#) [1332M107MS](#) [EAJ.1B.306.CWA](#) [1589430-](#)  
[2](#) [ELF.00.250.NTL](#) [ERA.01.250.DLL](#) [BRD.0B.200.PCSG](#) [HVP.03.250.CLLPV](#) [CAH.M34.SLL.C72GZ](#) [CAJ.M34.SLL.C72GZ](#) [300500](#)  
[EXG.0B.309.HLN](#) [FFB.1S.250.CLAC27](#) [FLC.00.250.CTAC31](#) [FPG.0B.305.CLAD52](#) [PCS.01.250.DLLE31](#) [PKC.M0.7GL.NG](#)  
[PKG.M0.4TL.LZ](#) [PXG.M0.8GG.NG](#) [HEG.1B.307.CLNP](#) [BRR.3S.200.PZVG](#) [JDXEP2T19FSN](#) [400374](#) [DTA.99.700.5Z](#) [ECG.00.304.CLL](#)  
[ECP.0S.304.CLN](#) [EEG.1B.306.CYZ](#) [MS3117-12BU](#) [EGA.00.303.CLL](#) [SAN.M13.GLA.6G](#) [6408-201V-11343](#) [6408-202V-25273](#)  
[PAC.M0.4NL.AC52J](#) [980-0009-471](#)