

SUMMARY

Wires

Low	3
High	0
Coax	0
Triax	0
Quad	0
Fiber	0
Fluidic	0

Series	1B
Termination type	Male solder
IP rating	50
Cable Ø	0.00 - 0.00 mm
Status	active
Alternative part	
Matching parts	EGG.1B.303.CLL PHG.1B.303.CLLZ



Image is for illustrative purpose only

Download

[Request a quote](#)

[Catalog](#)

[See video assembly instructions](#)

TECHNICAL DETAILS

Mechanics

Shell Style/Model	FG*: Straight plug, cable collet
Keying	1 key (alpha=0, plug: male contacts, receptacle: female contacts)
Housing Material	Brass (chrome plated) shell and collet nut, nickel plated brass latch sleeve and mid pieces
Variant	
Weight	14.09 g

Performance

Configuration	1B.303 : 3 Low Voltage
Insulator	L: PEEK (UL 94 / V-0/3.2, depends on material thickness)
Rated Current	12 Amps

Specifications

Contact Type:	Solder
Contact Dia.:	1.3 mm (0.051in)
Bucket Dia.:	1 mm (0.039in)

LEMO products and services are provided "as is". LEMO makes no warranties or representations with regard to LEMO product & services or use of them, express, implied or statutory, including for accuracy, completeness, or security. The user is fully responsible for his products and applications using LEMO components.

Max. Solid Conductor: 0.5 mm² (AWG 20)
 Max. Stranded Conductor: 0.5 mm² (AWG 20)
 R (max): 3.6 mOhm
 Vtest (contact-shell): 1550 V (AC), 2200 V (DC)
 Vtest (contact-contact): 1300 V (AC), 1840 V (DC)

Others

Endurance (Shell): 5000
 Temp (min / max): -55°C / +250°C
 Humidity (max): ≤95% [at 60 deg C / 140 F]
 Vibration: 15 g [10 Hz - 2000 Hz]
 Shock Resistance: 100 g [6 ms]
 Climatical Category: 50/175/21
 Shielding (min): 75 dB (10 MHz)
 Shielding (min): 40 dB (1 GHz)
 Salt Spray Corrosion: >1000 hr
 IP Rating: 50

DRAWINGS

Draws

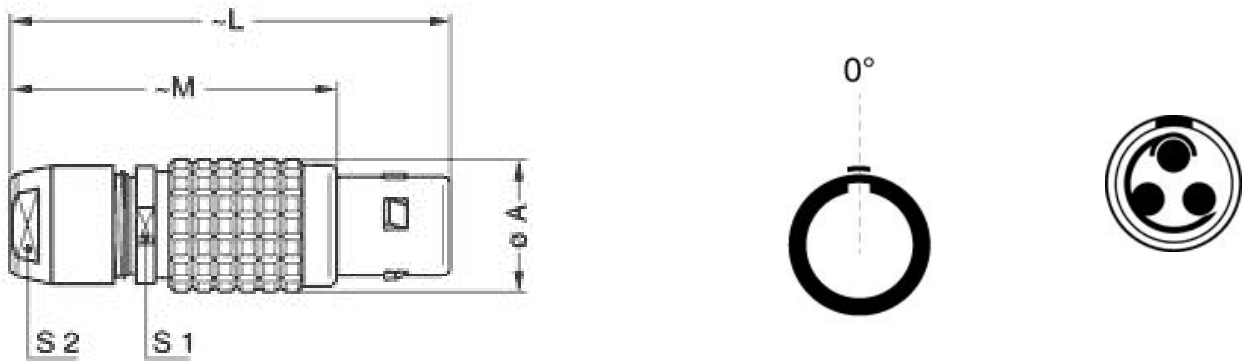

Dimensions

	A	L	M	S1	S2
mm.	12	43	32	10	9
in.	0,47	1,69	1,26	0,39	0,35

LEMO products and services are provided "as is". LEMO makes no warranties or representations with regard to LEMO product & services or use of them, express, implied or statutory, including for accuracy, completeness, or security. The user is fully responsible for his products and applications using LEMO components.

RECOMMENDED BY LEMO

Tools

Spanner wrench: DCD.1B.015.PA090
Caps: BFG.1B.100.PCSG

Cables

LEMO products and services are provided "as is". LEMO makes no warranties or representations with regard to LEMO product & services or use of them, express, implied or statutory, including for accuracy, completeness, or security. The user is fully responsible for his products and applications using LEMO components.

X-ON Electronics

Largest Supplier of Electrical and Electronic Components

Click to view similar products for [Circular Push Pull Connectors](#) category:

Click to view products by [LEMO](#) manufacturer:

Other Similar products are found below :

[6407-249V-11273P](#) [6408-201V-13273](#) [6408-202V-13343](#) [6408-202V-17343](#) [EZG.0B.309.CLN](#) [FFA.2S.310.ZLA](#) [FGA.1B.307.CYCD72Z](#)
[FGJ.1B.304.CLLD76](#) [FGJ.1B.306.CWLD72](#) [FGJ.3B.304.CYMD10Z](#) [FGJ.3B.304.CYMD82Z](#) [PCS.01.250.DLLE24](#) [PHG.0K.305.CYMC40Z](#)
[PHG.1K.308.CLLK85](#) [PKG.M0.6BL.LZ](#) [PLC.M1.0SL.LA](#) [GMA.10.290.DN](#) [GMA.3B.090.DA](#) [PRG.M0.6GL.LC52GZ](#) [PSA.1S.275.CTLC66](#)
[ABF.1S.250.NTA](#) [133020F](#) [1331ER193MZ](#) [1332M107MZ](#) [DTS26Z19-32JA-LC](#) [DTS26Z19-32SA](#) [DTS26Z19-32SA-LC](#) [DTS26Z23-55HA](#)
[DTS26Z23-55HA-LC](#) [DTS26Z23-55JA-LC](#) [EAJ.1B.306.CWA](#) [ECG.XB.312.CLL](#) [1589430-2](#) [EEA.0B.305.CLN](#) [EEA.0B.309.CLL](#)
[ELF.00.250.NTL](#) [ERA.01.250.DLL](#) [BRR.2S.200.PZVG](#) [HR10A-P](#) [CAH.M34.SLL.C72GZ](#) [CAJ.M34.SLL.C72GZ](#) [300500](#) [ESB.00.303.NLL](#)
[EXG.0B.309.HLN](#) [FFB.1S.250.CLAC27](#) [FGA.2B.306.CYCD92](#) [FGA.2B.306.CYCD92Z](#) [FGA.XB.312.CLAD72](#) [FGJ.1B.302.CYMD62](#)
[FGJ.3B.308.CLLD72Z](#)