

SUMMARY



Image is for illustrative purpose only

Wires

Low voltage 16

Series 2B
Termination type Male solder
IP rating 50
AWG wire size 30.00 - 22.00
Cable Ø 3.30 - 4.20 mm
Status active
Matching parts [EGG.2B.316.CLL](#)

Download

[Request a quote](#)
[Eplan](#)
[Catalog](#)
[See video assembly instructions](#)

TECHNICAL DETAILS

Mechanics

Shell Style/Model FG*: Straight plug, cable collet and nut for fitting a bend relief
Keying 1 key (alpha=0, plug: male contacts, receptacle: female contacts)
Housing Material Brass (chrome plated [SAE AMS 2460]) shell and collet nut, nickel plated [SAE AMS QQ N 290] brass latch sleeve and mid pieces
Variant Z : Nut for fitting a bend relief
Weight 30.33 g

Performance

Configuration 2B.316 : 16 Low Voltage
Insulator L: PEEK (UL 94 / V-0/1.5)
Rated Current 6 Amps

Specifications

Contact Type: Solder
Contact Dia.: 0.7 mm (0.028in)
Bucket Dia.: 0.8 mm (0.031in)
Max. Stranded Conductor: 0.34 mm² (AWG 22)
Max. Conductor: 0.34 mm² (AWG 22)
R (max): 6.1 mOhm

LEMO products and services are provided "as is". LEMO makes no warranties or representations with regard to LEMO product & services or use of them, express, implied or statutory, including for accuracy, completeness, or security. The user is fully responsible for his products and applications using LEMO components.

Vtest (contact-shell): 1250 V (AC), 1770 V (DC)
Vtest (contact-contact): 950 V (AC), 1340 V (DC)

Others

Endurance (Shell): 5000
Temp (min / max): -55°C / +250°C
Humidity (max): <=95% [at 60 deg C / 140 F]
Vibration: 15 g [10 Hz - 2000 Hz]
Shock Resistance: 100 g [6 ms]
Climatical Category: 50/175/21
Shielding (min): 75 dB (10 MHz)
Shielding (min): 40 dB (1 GHz)
Salt Spray Corrosion: >1000 hr

DRAWINGS

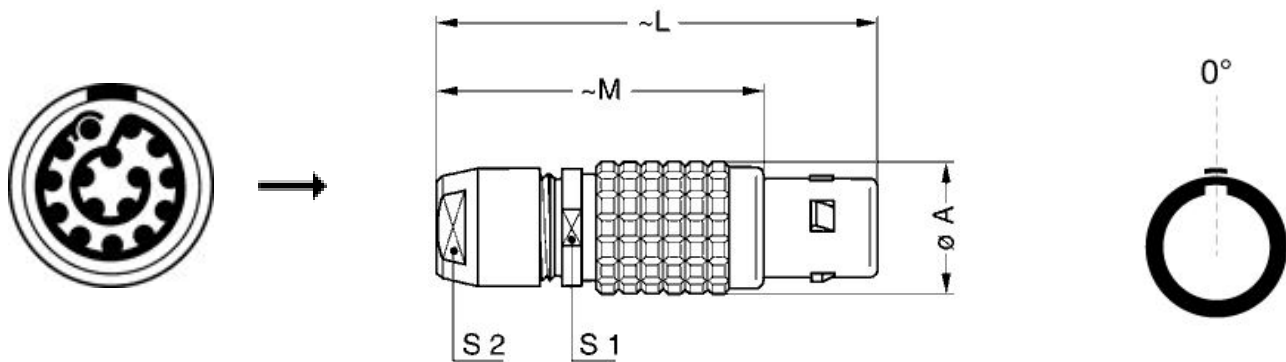

Dimensions

	A	L	M	S1	S2
mm.	15	49	37	13	12
in.	0,59	1,93	1,46	0,51	0,47

RECOMMENDED BY LEMO

Tools

LEMO products and services are provided "as is". LEMO makes no warranties or representations with regard to LEMO product & services or use of them, express, implied or statutory, including for accuracy, completeness, or security. The user is fully responsible for his products and applications using LEMO components.

Spanner wrench: [DCD.2B.025.PA120](#)

Caps: [BFG.2B.100.PCSG](#)

LEMO products and services are provided "as is". LEMO makes no warranties or representations with regard to LEMO product & services or use of them, express, implied or statutory, including for accuracy, completeness, or security. The user is fully responsible for his products and applications using LEMO components.

X-ON Electronics

Largest Supplier of Electrical and Electronic Components

Click to view similar products for [Circular Push Pull Connectors](#) category:

Click to view products by [LEMO](#) manufacturer:

Other Similar products are found below :

[6407-249V-11273P](#) [6408-201V-13273](#) [6408-202V-13343](#) [6408-202V-17343](#) [EZG.0B.309.CLN](#) [FFA.2S.310.ZLA](#) [FGA.1B.307.CYCD72Z](#)
[FGJ.1B.304.CLLD76](#) [FGJ.1B.306.CWLD72](#) [FGJ.3B.304.CYMD10Z](#) [FGJ.3B.304.CYMD82Z](#) [PCS.01.250.DLLE24](#) [PHG.0K.305.CYMC40Z](#)
[PHG.1K.308.CLLK85](#) [PKG.M0.6BL.LZ](#) [PLC.M1.0SL.LA](#) [GMA.10.290.DN](#) [GMA.3B.090.DA](#) [PRG.M0.6GL.LC52GZ](#) [PSA.1S.275.CTLC66](#)
[ABF.1S.250.NTA](#) [133020F](#) [1331ER193MZ](#) [1332M107MZ](#) [DTS26Z19-32JA-LC](#) [DTS26Z19-32SA](#) [DTS26Z19-32SA-LC](#) [DTS26Z23-55HA](#)
[DTS26Z23-55HA-LC](#) [DTS26Z23-55JA-LC](#) [EAJ.1B.306.CWA](#) [ECG.XB.312.CLL](#) [1589430-2](#) [EEA.0B.305.CLN](#) [EEA.0B.309.CLL](#)
[ELF.00.250.NTL](#) [ERA.01.250.DLL](#) [BRR.2S.200.PZVG](#) [HR10A-P](#) [CAH.M34.SLL.C72GZ](#) [CAJ.M34.SLL.C72GZ](#) [300500](#) [ESB.00.303.NLL](#)
[EXG.0B.309.HLN](#) [FFB.1S.250.CLAC27](#) [FGA.2B.306.CYCD92](#) [FGA.2B.306.CYCD92Z](#) [FGA.XB.312.CLAD72](#) [FGJ.1B.302.CYMD62](#)
[FGJ.3B.308.CLLD72Z](#)