

## SUMMARY

### # Wires

Low voltage 3



*Image is for illustrative purpose only*

Series 3B  
Termination type Female solder  
IP rating 50  
AWG wire size 22.00 - 14.00  
Cable Ø 4.90 - 6.20 mm  
Status active  
Matching parts [EGJ.3B.303.CLA](#)

### Download

[Request a quote](#)  
[Eplan](#)  
[Catalog](#)

## TECHNICAL DETAILS

### Mechanics

Shell Style/Model FG\*: Straight plug, cable collet  
Keying 2 keys (alpha=37.5, plug: female contacts, receptacle: male contacts)  
Housing Material Brass (chrome plated [SAE AMS 2460]) shell and collet nut, nickel plated [SAE AMS QQ N 290] brass latch sleeve and mid pieces  
Weight 49.79 g

### Performance

Configuration 3B.303 : 3 Low Voltage  
Insulator L: PEEK (UL 94 / V-0/1.5)  
Rated Current 25 Amps

### Specifications

Contact Type: Solder  
Contact Dia.: 2 mm (0.079in)  
Bucket Dia.: 1.8 mm (0.071in)  
Max. Solid Conductor: 1.5 mm<sup>2</sup> (AWG 14)  
Max. Stranded Conductor: 1.5 mm<sup>2</sup> (AWG 16)  
R (max): 3.3 mOhm  
Vtest (contact-shell): 1500 V (AC), 2120 V (DC)  
Vtest (contact-contact): 1900 V (AC), 2700 V (DC)

*LEMO products and services are provided "as is". LEMO makes no warranties or representations with regard to LEMO product & services or use of them, express, implied or statutory, including for accuracy, completeness, or security. The user is fully responsible for his products and applications using LEMO components.*

## Others

Endurance (Shell): 5000  
Temp (min / max): -55 °C / +250 °C  
Humidity (max): <=95% [at 60 deg C / 140 F]  
Vibration: 15 g [10 Hz - 2000 Hz]  
Shock Resistance: 100 g [ 6 ms]  
Climatical Category: 50/175/21  
Shielding (min): 75 dB (10 MHz)  
Shielding (min): 40 dB (1 GHz)  
Salt Spray Corrosion: >1000 hr

## DRAWINGS

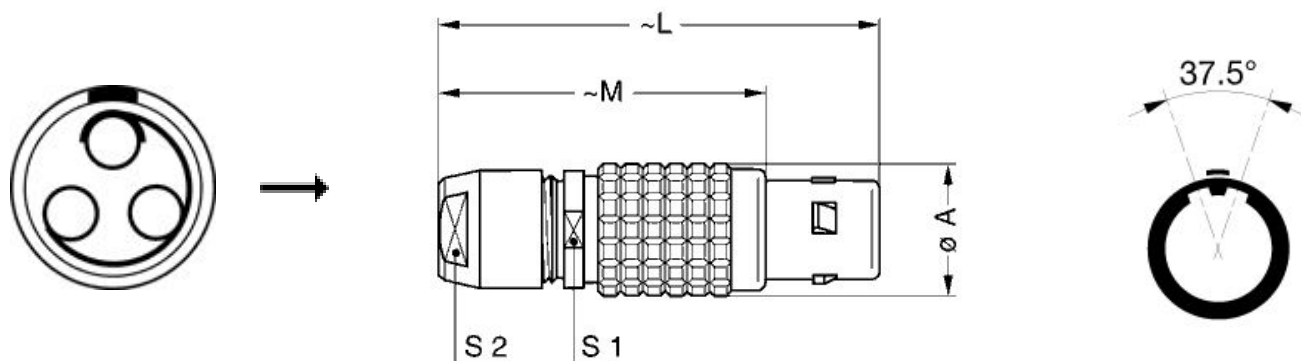

## Dimensions

	A	L	M	S1	S2
mm.	18	58	43	15	14
in.	0,71	2,28	1,69	0,59	0,55









## RECOMMENDED BY LEMO

### Tools

Spanner wrench: [DCD.3B.040.PA140](#)

*LEMO products and services are provided "as is". LEMO makes no warranties or representations with regard to LEMO product & services or use of them, express, implied or statutory, including for accuracy, completeness, or security. The user is fully responsible for his products and applications using LEMO components.*

## Cables

CMN.03.T18.055PGZE		Grey	
CMN.03.T18.055PNZE			
CMN.03.T18.055QGZE	TPR (medical)	Grey	
CMN.03.T20.049PGZE		Grey	
CMN.03.T20.049PNZE			
230500	PVC	Grey	
230750	PVC	Grey	
3220	PVC	Black	

LEMO products and services are provided "as is". LEMO makes no warranties or representations with regard to LEMO product & services or use of them, express, implied or statutory, including for accuracy, completeness, or security. The user is fully responsible for his products and applications using LEMO components.

## X-ON Electronics

Largest Supplier of Electrical and Electronic Components

*Click to view similar products for [Circular Push Pull Connectors](#) category:*

*Click to view products by [LEMO](#) manufacturer:*

Other Similar products are found below :

[6407-249V-11273P](#) [6408-201V-13273](#) [6408-202V-13343](#) [6408-202V-17343](#) [EZG.0B.309.CLN](#) [FFA.2S.310.ZLA](#) [FGA.1B.307.CYCD72Z](#)  
[FGJ.1B.304.CLLD76](#) [FGJ.1B.306.CWLD72](#) [FGJ.3B.304.CYMD10Z](#) [FGJ.3B.304.CYMD82Z](#) [PCS.01.250.DLLE24](#) [PHG.0K.305.CYMC40Z](#)  
[PHG.1K.308.CLLK85](#) [PKG.M0.6BL.LZ](#) [PLC.M1.0SL.LA](#) [GMA.10.290.DN](#) [GMA.3B.090.DA](#) [PRG.M0.6GL.LC52GZ](#) [PSA.1S.275.CTLC66](#)  
[ABF.1S.250.NTA](#) [133020F](#) [1331ER193MZ](#) [1332M107MZ](#) [DTS26Z19-32JA-LC](#) [DTS26Z19-32SA](#) [DTS26Z19-32SA-LC](#) [DTS26Z23-55HA](#)  
[DTS26Z23-55HA-LC](#) [DTS26Z23-55JA-LC](#) [EAJ.1B.306.CWA](#) [ECG.XB.312.CLL](#) [1589430-2](#) [EEA.0B.305.CLN](#) [EEA.0B.309.CLL](#)  
[ELF.00.250.NTL](#) [ERA.01.250.DLL](#) [BRR.2S.200.PZVG](#) [HR10A-P](#) [CAH.M34.SLL.C72GZ](#) [CAJ.M34.SLL.C72GZ](#) [300500](#) [ESB.00.303.NLL](#)  
[EXG.0B.309.HLN](#) [FFB.1S.250.CLAC27](#) [FGA.2B.306.CYCD92](#) [FGA.2B.306.CYCD92Z](#) [FGA.XB.312.CLAD72](#) [FGJ.1B.302.CYMD62](#)  
[FGJ.3B.308.CLLD72Z](#)