

## SUMMARY

### # Wires

Low voltage 4



*Image is for illustrative purpose only*

Series 0F  
Termination type Male crimp  
IP rating 67  
AWG wire size 26.00 - 22.00  
Cable Ø 3.80 - 9.00 mm  
Status active  
Matching parts [EGN.0F.304.XLM](#)

### Download

[Request a quote](#)  
[Catalog](#)  
[See video assembly instructions](#)

## TECHNICAL DETAILS

### Mechanics

Shell Style/Model FG\*: Straight plug  
Keying 3 keys (beta=165, gamma=30, plug: male contacts, receptacle: female contacts)  
Housing Material Aluminium (nickel plated [SAE AMS QQ N 290], anthracite color) shell and nut, other pieces bronze/brass  
Weight 6.60 g

### Performance

Configuration 0F.304 : 4 Low Voltage  
Insulator L: PEEK (UL 94 / V-0/1.5)  
Rated Current 7 Amps

### Specifications

Contact Type: Crimp  
Contact Retention: 22 N  
Contact Dia.: 0.7 mm (0.028in)  
Bucket Dia.: 0.8 mm (0.031in)  
Min. Conductor: 0.14 mm<sup>2</sup> (AWG 26)  
Max. Conductor: 0.34 mm<sup>2</sup> (AWG 22)  
R (max): 6.1 mOhm  
Vtest (contact-shell): 1100 V (AC), 1560 V (DC)

*LEMO products and services are provided "as is". LEMO makes no warranties or representations with regard to LEMO product & services or use of them, express, implied or statutory, including for accuracy, completeness, or security. The user is fully responsible for his products and applications using LEMO components.*

Vtest (contact-contact): 1350 V (AC), 1910 V (DC)

## Others

Endurance (Shell): 1000 mating cycles  
Temp (min / max): -15°C / +200°C  
Humidity (max): <=95% [at 60 deg C / 140 F]  
Vibration: 15 g [10 Hz - 2000 Hz]  
Shock Resistance: 100 g [ 6 ms]  
Climatical Category: 15/200/21 (Aluminium shell)  
Salt Spray Corrosion: max. 48 hr

## DRAWINGS

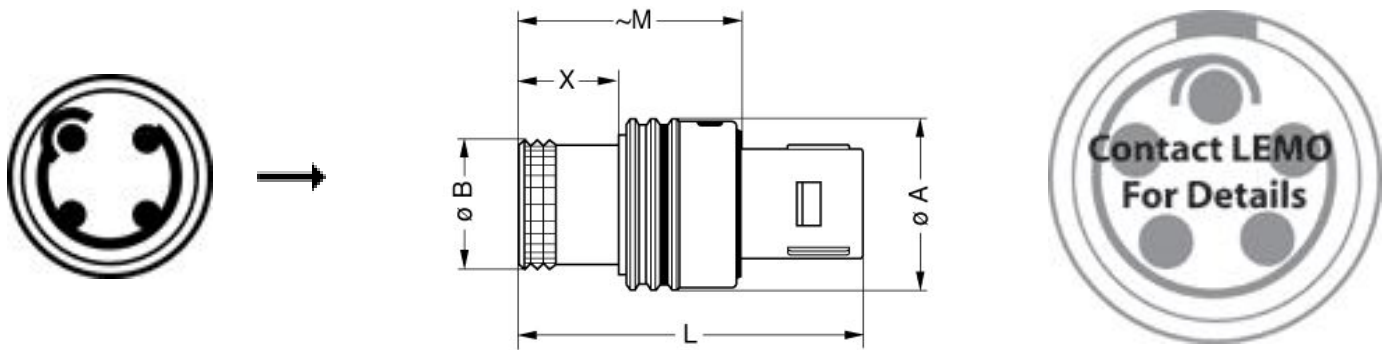

## Dimensions

	A	B	L	M	X
mm.	12	9	27.5	17.8	8
in.	0,47	0,35	1,08	0,70	0,31

## RECOMMENDED BY LEMO

### Tools











Crimp Tool: [DPC.91.701.V](#)

Crimp settings: AWG/Selector = 22-24-26/6-5-5

*LEMO products and services are provided "as is". LEMO makes no warranties or representations with regard to LEMO product & services or use of them, express, implied or statutory, including for accuracy, completeness, or security. The user is fully responsible for his products and applications using LEMO components.*

Positionner: [DCE.91.070.BVC](#)  
 Extractor: [DCF.93.070.4LT](#)  
 Replacement contact: FGG.0B.555.ZZC

## Cables

CMN.04.T22.047QGC	TPR	Grey	
CMN.04.T22.048QGZE	TPR (medical)	Grey	
140240	PVC	Black	
140250	PVC	Grey	
40140	PVC	Black	
40260	PVC	Black	
4080	PVC	Grey	
417920	PVC	Grey	
4220	PVC	Black	
4221	PVC	Black	
4280	PVC	Black	
80080	PVC	Grey	
80082	PVC	Red	
80084	PVC	Black	
CTR.75.030.121870G	PVC	Grey	

LEMO products and services are provided "as is". LEMO makes no warranties or representations with regard to LEMO product & services or use of them, express, implied or statutory, including for accuracy, completeness, or security. The user is fully responsible for his products and applications using LEMO components.

## X-ON Electronics

Largest Supplier of Electrical and Electronic Components

*Click to view similar products for [Standard Circular Connector](#) category:*

*Click to view products by [LEMO](#) manufacturer:*

Other Similar products are found below :

[5M2530B10P](#) [600259N006](#) [600273N007](#) [6134-336-13149](#) [6134-337-11149](#) [6134-337-2390](#) [6134-341-17149](#) [6280-4SG-516](#) [6280-7SG-3DC](#)  
[6290](#) [6291A](#) [66200A-10](#) [680-SMG](#) [681-PMG](#) [CXS3102A14S2P](#) [CXS3102A181S](#) [7251-6SG-300](#) [7271-6SG-300](#) [7282-3PG-300-CH3](#) [75-](#)  
[474014-05S](#) [75-474618-01S](#) [75-474618-04P](#) [75-474618-04S](#) [799539-000](#) [MI8-SE](#) [805-005-07NF11-19PC](#) [805-005-07NF15-7PA](#) [8280-4PG-](#)  
[516](#) [8280-7PG-519](#) [8282-5PG-519](#) [836783-1](#) [MP-4102-25P-C](#) [862256-1](#) [864019-2](#) [866857-1](#) [867865-1](#) [PT01SP-14-18P](#) [PT08P-14-5S](#)  
[PTSF06SE-14-12S](#) [120-1833-000](#) [QCM019PC2DC012B](#) [1-2069279-1](#) [121583-0217](#) [121667-0020](#) [129591AU](#) [1000B BULK](#) [RD10A16-19-](#)  
[P6CS051/1](#) [RD10A20-31-P8CS051/1](#) [RD16A14-12-S6CS051/2](#) [1301240290](#) [1301240347](#)