

## SUMMARY

### # Wires

Low voltage 4



*Image is for illustrative purpose only*

Series FF  
Termination type Male crimp  
IP rating 67  
AWG wire size 32.00 - 28.00  
Cable Ø 2.20 - 6.30 mm  
Status active

### Download

[Request a quote](#)  
[Eplan](#)  
[Catalog](#)  
[See video assembly instructions](#)

## TECHNICAL DETAILS

### Mechanics

Shell Style/Model FG\*: Straight plug  
Keying  
Housing Material Aluminium (nickel plated [SAE AMS QQ N 290], anthracite color) shell and nut, other pieces beryllium copper  
Weight 3.13 g

### Performance

Configuration  
Insulator L: PEEK (UL 94 / V-0/1.5)  
Rated Current 2 Amps

### Specifications

Contact Type: Crimp  
Contact Retention: 12 N  
Contact Dia.: 0.5 mm (0.02in)  
Bucket Dia.: 0.45 mm (0.018in)  
Min. Conductor: 0.035 mm<sup>2</sup> (AWG 32)  
Max. Conductor: 0.09 mm<sup>2</sup> (AWG 28)  
R (max): 8.7 mOhm

*LEMO products and services are provided "as is". LEMO makes no warranties or representations with regard to LEMO product & services or use of them, express, implied or statutory, including for accuracy, completeness, or security. The user is fully responsible for his products and applications using LEMO components.*

## Others

Endurance (Shell): 300 mating cycles  
Temp (min / max): -15°C / +200°C  
Humidity (max): <=95% [at 60 deg C / 140 F]  
Vibration: 15 g [10 Hz - 2000 Hz]  
Shock Resistance: 100 g [ 6 ms]  
Climatical Category: 15/200/21 (Aluminium shell)

---

## DRAWINGS

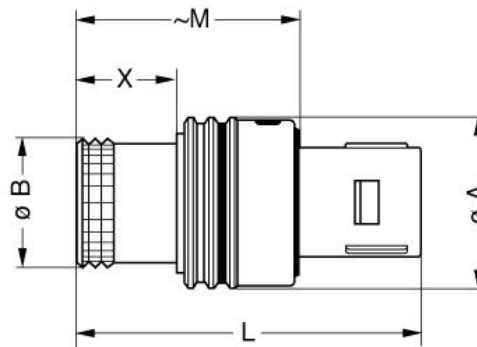

## Dimensions

	A	B	L	M	X
mm.	8.5	6.3	21.6	13.8	5.7
in.	0,33	0,25	0,85	0,54	0,22

---







## RECOMMENDED BY LEMO

### Tools

Crimp Tool: [DPC.91.701.V](#)  
Crimp settings: AWG/Selector = 28-30-32/4-3-3  
Positionner: [DCE.91.050.0VC](#)  
Extractor: [DCF.91.050.2LT](#)  
Replacement contact: [FGG.00.554.ZZC](#)

*LEMO products and services are provided "as is". LEMO makes no warranties or representations with regard to LEMO product & services or use of them, express, implied or statutory, including for accuracy, completeness, or security. The user is fully responsible for his products and applications using LEMO components.*

## Cables

CMN.04.T28.031PGCE	PVC	GREY	
CMN.04.T28.031PGZE		Grey	
CMN.04.T28.031PNCE	PVC	Black	
CMN.04.T28.031PNZE			
CMN.04.T28.031QGC	TPR	Grey	
40080	PVC	Black	
40086	PVC	Blue	
4041	PVC	Grey	
4050	PVC	Black	
4080	PVC	Grey	
4280	PVC	Black	
80080	PVC	Grey	
80082	PVC	Red	
80084	PVC	Black	

LEMO products and services are provided "as is". LEMO makes no warranties or representations with regard to LEMO product & services or use of them, express, implied or statutory, including for accuracy, completeness, or security. The user is fully responsible for his products and applications using LEMO components.

## X-ON Electronics

Largest Supplier of Electrical and Electronic Components

*Click to view similar products for [Standard Circular Connector](#) category:*

*Click to view products by [LEMO](#) manufacturer:*

Other Similar products are found below :

[5M2530B10P](#) [600259N006](#) [600273N007](#) [6134-336-13149](#) [6134-337-11149](#) [6134-337-2390](#) [6134-341-17149](#) [6280-4SG-516](#) [6280-7SG-3DC](#)  
[6290](#) [6291A](#) [66200A-10](#) [680-SMG](#) [681-PMG](#) [CXS3102A14S2P](#) [CXS3102A181S](#) [7251-6SG-300](#) [7271-6SG-300](#) [7282-3PG-300-CH3](#) [75-](#)  
[474014-05S](#) [75-474618-01S](#) [75-474618-04P](#) [75-474618-04S](#) [799539-000](#) [MI8-SE](#) [805-005-07NF11-19PC](#) [805-005-07NF15-7PA](#) [8280-4PG-](#)  
[516](#) [8280-7PG-519](#) [8282-5PG-519](#) [836783-1](#) [MP-4102-25P-C](#) [862256-1](#) [864019-2](#) [866857-1](#) [867865-1](#) [PT01SP-14-18P](#) [PT08P-14-5S](#)  
[PTSF06SE-14-12S](#) [120-1833-000](#) [QCM019PC2DC012B](#) [1-2069279-1](#) [121583-0217](#) [121667-0020](#) [129591AU](#) [1000B BULK](#) [RD10A16-19-](#)  
[P6CS051/1](#) [RD10A20-31-P8CS051/1](#) [RD16A14-12-S6CS051/2](#) [1301240290](#) [1301240347](#)