

SUMMARY

Wires

Low voltage 3



Image is for illustrative purpose only

Series 0F
Termination type Male crimp
IP rating 67
AWG wire size 24.00 - 20.00
Cable Ø 3.80 - 9.00 mm
Status active
Matching parts [EGP.0F.303.XLM](#)

Download

[Request a quote](#)
[Catalog](#)
[See video assembly instructions](#)

TECHNICAL DETAILS

Mechanics

Shell Style/Model FG*: Straight plug
Keying 3 keys (beta=150, gamma=60, plug: male contacts, receptacle: female contacts)
Housing Material Aluminium (nickel plated [SAE AMS QQ N 290], anthracite color) shell and nut, other pieces bronze/brass
Weight 6.15 g

Performance

Configuration 0F.303 : 3 Low Voltage
Insulator L: PEEK (UL 94 / V-0/1.5)
Rated Current 8 Amps

Specifications

Contact Type: Crimp
Contact Retention: 30 N
Contact Dia.: 0.9 mm (0.035in)
Bucket Dia.: 1.1 mm (0.043in)
Min. Conductor: 0.25 mm² (AWG 24)
Max. Conductor: 0.5 mm² (AWG 20)
R (max): 4.8 mOhm
Vtest (contact-shell): 1600 V (AC), 2300 V (DC)

LEMO products and services are provided "as is". LEMO makes no warranties or representations with regard to LEMO product & services or use of them, express, implied or statutory, including for accuracy, completeness, or security. The user is fully responsible for his products and applications using LEMO components.

Vtest (contact-contact): 1700 V (AC), 2400 V (DC)

Others

Endurance (Shell): 1000 mating cycles
Temp (min / max): -15°C / +200°C
Humidity (max): <=95% [at 60 deg C / 140 F]
Vibration: 15 g [10 Hz - 2000 Hz]
Shock Resistance: 100 g [6 ms]
Climatical Category: 15/200/21 (Aluminium shell)
Salt Spray Corrosion: max. 48 hr

DRAWINGS

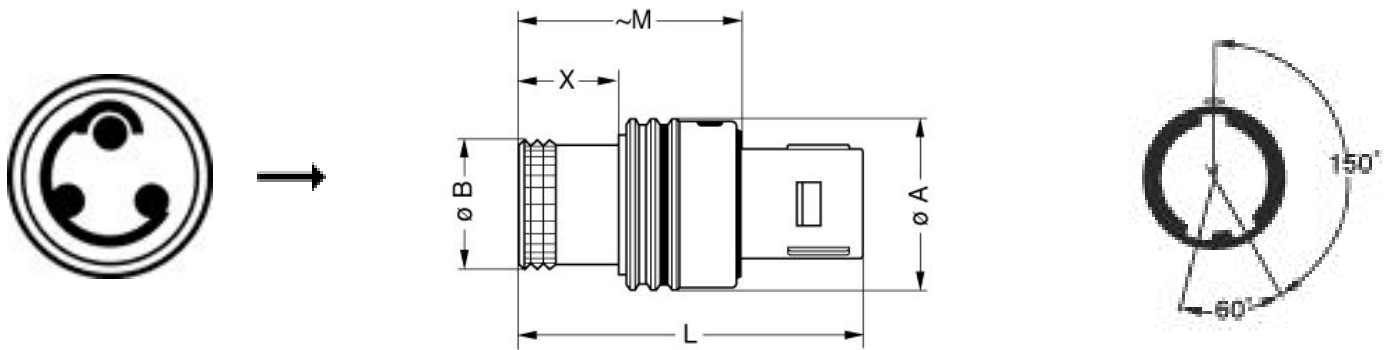

Dimensions

	A	B	L	M	X
mm.	12	9	27.5	17.8	8
in.	0,47	0,35	1,08	0,70	0,31

RECOMMENDED BY LEMO

Tools









Crimp Tool: [DPC.91.701.V](#)

Crimp settings: AWG/Selector = 20-22-24/6-5-5

LEMO products and services are provided "as is". LEMO makes no warranties or representations with regard to LEMO product & services or use of them, express, implied or statutory, including for accuracy, completeness, or security. The user is fully responsible for his products and applications using LEMO components.

Positionner: [DCE.91.070.BVC](#)
 Extractor: [DCF.93.090.4LT](#)
 Replacement contact: FGG.0B.560.ZZC

Cables

CMN.03.T20.049PGZE		Grey	
CMN.03.T20.049PNZE			
130240	PVC	Black	
130250	PVC	Grey	
230500	PVC	Grey	
230750	PVC	Grey	
30110	PVC	Grey	
30260	PVC	Black	
3220	PVC	Black	
3280	PVC	Black	
60080	PVC	Grey	

LEMO products and services are provided "as is". LEMO makes no warranties or representations with regard to LEMO product & services or use of them, express, implied or statutory, including for accuracy, completeness, or security. The user is fully responsible for his products and applications using LEMO components.

X-ON Electronics

Largest Supplier of Electrical and Electronic Components

Click to view similar products for [Circular Push Pull Connectors](#) category:

Click to view products by [LEMO](#) manufacturer:

Other Similar products are found below :

[6407-249V-11273P](#) [6408-201V-13273](#) [6408-202V-13343](#) [6408-202V-17343](#) [EZG.0B.309.CLN](#) [FFA.2S.310.ZLA](#) [FGA.1B.307.CYCD72Z](#)
[FGJ.1B.304.CLLD76](#) [FGJ.1B.306.CWLD72](#) [FGJ.3B.304.CYMD10Z](#) [FGJ.3B.304.CYMD82Z](#) [PCS.01.250.DLLE24](#) [PHG.0K.305.CYMC40Z](#)
[PHG.1K.308.CLLK85](#) [PKG.M0.6BL.LZ](#) [PLC.M1.0SL.LA](#) [GMA.10.290.DN](#) [GMA.3B.090.DA](#) [PRG.M0.6GL.LC52GZ](#) [PSA.1S.275.CTLC66](#)
[ABF.1S.250.NTA](#) [133020F](#) [1331ER193MZ](#) [1332M107MZ](#) [DTS26Z19-32JA-LC](#) [DTS26Z19-32SA](#) [DTS26Z19-32SA-LC](#) [DTS26Z23-55HA](#)
[DTS26Z23-55HA-LC](#) [DTS26Z23-55JA-LC](#) [EAJ.1B.306.CWA](#) [ECG.XB.312.CLL](#) [1589430-2](#) [EEA.0B.305.CLN](#) [EEA.0B.309.CLL](#)
[ELF.00.250.NTL](#) [ERA.01.250.DLL](#) [BRR.2S.200.PZVG](#) [HR10A-P](#) [CAH.M34.SLL.C72GZ](#) [CAJ.M34.SLL.C72GZ](#) [300500](#) [ESB.00.303.NLL](#)
[EXG.0B.309.HLN](#) [FFB.1S.250.CLAC27](#) [FGA.2B.306.CYCD92](#) [FGA.2B.306.CYCD92Z](#) [FGA.XB.312.CLAD72](#) [FGJ.1B.302.CYMD62](#)
[FGJ.3B.308.CLLD72Z](#)