

## SUMMARY

### # Wires

Low voltage 12



*Image is for illustrative purpose only*

Series 2F  
Termination type Female crimp  
IP rating 67  
AWG wire size 26.00 - 22.00  
Cable Ø 5.30 - 14.00 mm  
Status active

### Download

[Request a quote](#)

[Eplan](#)

[Catalog](#)

## TECHNICAL DETAILS

### Mechanics

Shell Style/Model FG\*: Straight plug  
Keying 3 keys (beta=155, gamma=50, plug: female contacts, receptacle: male contacts)  
Housing Material Brass (chrome plated [SAE AMS 2460]) shell and nut, other pieces brass  
Weight 17.34 g

### Performance

Configuration 2F.312 : 12 Low Voltage  
Insulator L: PEEK (UL 94 / V-0/1.5)  
Rated Current 7 Amps

### Specifications

Contact Type: Crimp  
Contact Retention: 22 N  
Contact Dia.: 0.7 mm (0.028in)  
Bucket Dia.: 0.8 mm (0.031in)  
Min. Conductor: 0.14 mm<sup>2</sup> (AWG 26)  
Max. Conductor: 0.34 mm<sup>2</sup> (AWG 22)  
R (max): 6.1 mOhm  
Vtest (contact-shell): 2000 V (AC), 2850 V (DC)  
Vtest (contact-contact): 1650 V (AC), 2350 V (DC)

*LEMO products and services are provided "as is". LEMO makes no warranties or representations with regard to LEMO product & services or use of them, express, implied or statutory, including for accuracy, completeness, or security. The user is fully responsible for his products and applications using LEMO components.*

## Others

Endurance (Shell): 5000 mating cycles  
Temp (min / max): -55 °C / +200 °C  
Humidity (max): <=95% [at 60 deg C / 140 F]  
Vibration: 15 g [10 Hz - 2000 Hz]  
Shock Resistance: 100 g [ 6 ms]  
Climatical Category: 50/175/21 (Aluminium shell)  
Salt Spray Corrosion: >1000 hr

## DRAWINGS

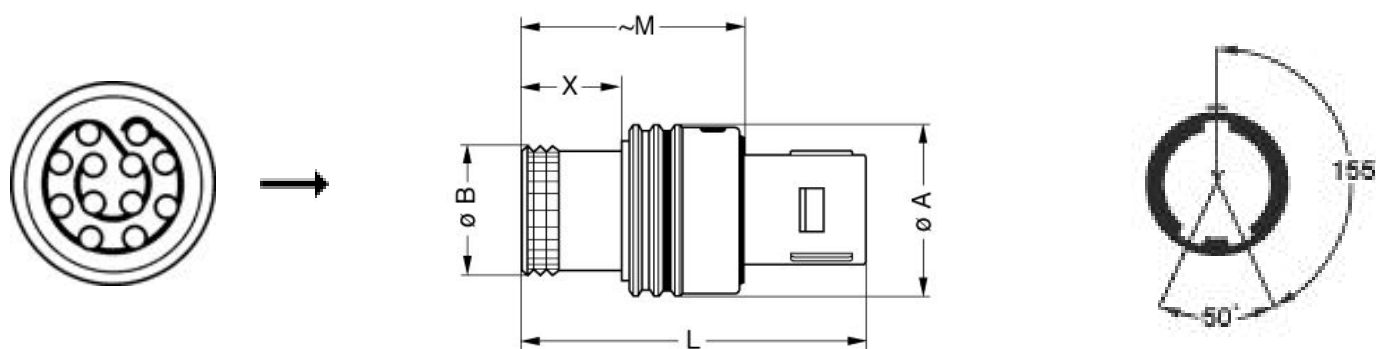

## Dimensions

	A	B	L	M	X
mm.	17	14	27.8	17.9	8
in.	0,67	0,55	1,09	0,70	0,31

## RECOMMENDED BY LEMO

### Tools











Crimp Tool: [DPC.91.701.V](#)  
Crimp settings: AWG/Selector = 22-24-26/6-5-5  
Positionner: [DCE.91.070.BVM](#)

*LEMO products and services are provided "as is". LEMO makes no warranties or representations with regard to LEMO product & services or use of them, express, implied or statutory, including for accuracy, completeness, or security. The user is fully responsible for his products and applications using LEMO components.*

Extractor: [DCF.93.070.4LT](#)

Replacement contact: EGG.0B.655.ZZM

## Cables

CMN.12.T22.070QGZE	TPR (medical)	Grey	
CMN.12.T28.054PGZE		Grey	
CMN.12.T28.054PNZE			
112240	PTFE	White	
112260	PTFE	White	
112280	PVC	Black	
124080	PVC	Grey	
124084	PVC	Black	
212220	PVC	Black	
212240	PVC	Black	
212250	PVC	Grey	
212260	PVC	Black	

LEMO products and services are provided "as is". LEMO makes no warranties or representations with regard to LEMO product & services or use of them, express, implied or statutory, including for accuracy, completeness, or security. The user is fully responsible for his products and applications using LEMO components.

## X-ON Electronics

Largest Supplier of Electrical and Electronic Components

*Click to view similar products for [Circular Push Pull Connectors](#) category:*

*Click to view products by [LEMO](#) manufacturer:*

Other Similar products are found below :

[6407-249V-11273P](#) [6408-201V-13273](#) [6408-202V-13343](#) [6408-202V-17343](#) [EZG.0B.309.CLN](#) [FFA.2S.310.ZLA](#) [FGA.1B.307.CYCD72Z](#)  
[FGJ.1B.304.CLLD76](#) [FGJ.1B.306.CWLD72](#) [FGJ.3B.304.CYMD10Z](#) [FGJ.3B.304.CYMD82Z](#) [PCS.01.250.DLLE24](#) [PHG.0K.305.CYMC40Z](#)  
[PHG.1K.308.CLLK85](#) [PKG.M0.6BL.LZ](#) [PLC.M1.0SL.LA](#) [GMA.10.290.DN](#) [GMA.3B.090.DA](#) [PRG.M0.6GL.LC52GZ](#) [PSA.1S.275.CTLC66](#)  
[ABF.1S.250.NTA](#) [133020F](#) [1331ER193MZ](#) [1332M107MZ](#) [DTS26Z19-32JA-LC](#) [DTS26Z19-32SA](#) [DTS26Z19-32SA-LC](#) [DTS26Z23-55HA](#)  
[DTS26Z23-55HA-LC](#) [DTS26Z23-55JA-LC](#) [EAJ.1B.306.CWA](#) [ECG.XB.312.CLL](#) [1589430-2](#) [EEA.0B.305.CLN](#) [EEA.0B.309.CLL](#)  
[ELF.00.250.NTL](#) [ERA.01.250.DLL](#) [BRR.2S.200.PZVG](#) [HR10A-P](#) [CAH.M34.SLL.C72GZ](#) [CAJ.M34.SLL.C72GZ](#) [300500](#) [ESB.00.303.NLL](#)  
[EXG.0B.309.HLN](#) [FFB.1S.250.CLAC27](#) [FGA.2B.306.CYCD92](#) [FGA.2B.306.CYCD92Z](#) [FGA.XB.312.CLAD72](#) [FGJ.1B.302.CYMD62](#)  
[FGJ.3B.308.CLLD72Z](#)