

SUMMARY

Wires

Low voltage 8



Image is for illustrative purpose only

Series	1B
Termination type	Female solder
IP rating	68
AWG wire size	30.00 - 22.00
Cable Ø	0.00 - 0.00 mm
Status	active
Matching parts	FGB.1B.308.CLAD42

Download

[Request a quote](#)

[Eplan](#)

[Catalog](#)

TECHNICAL DETAILS

Mechanics

Shell Style/Model	HG*: Fixed receptacle, nut fixing, watertight or vacuum-tight
Keying	2 keys (alpha=60, plug: male contacts, receptacle: female contacts)
Housing Material	Brass (chrome plated [SAE AMS 2460]) shell and collet nut, nickel plated [SAE AMS QQ N 290] brass latch sleeve and mid pieces
Variant	P : Watertight
Weight	13.70 g

Performance

Configuration	1B.308 : 8 Low Voltage
Insulator	L: PEEK (UL 94 / V-0/1.5)
Rated Current	5 Amps

Specifications

Contact Type:	Solder
Contact Dia.:	0.7 mm (0.028in)
Bucket Dia.:	0.8 mm (0.031in)
Max. Solid Conductor:	0.34 mm ² (AWG 22)
Max. Stranded Conductor:	0.34 mm ² (AWG 22)
R (max):	6.1 mOhm

LEMO products and services are provided "as is". LEMO makes no warranties or representations with regard to LEMO product & services or use of them, express, implied or statutory, including for accuracy, completeness, or security. The user is fully responsible for his products and applications using LEMO components.

Vtest (contact-shell): 1150 V (AC), 1630 V (DC)
 Vtest (contact-contact): 950 V (AC), 1340 V (DC)

Others

Endurance (Shell): 5000
 Temp (min / max): -20°C / +100°C
 Humidity (max): <=95% [at 60 deg C / 140 F]
 Vibration: 15 g [10 Hz - 2000 Hz]
 Shock Resistance: 100 g [6 ms]
 Climatical Category: 20/80/21
 Shielding (min): 75 dB (10 MHz)
 Shielding (min): 40 dB (1 GHz)
 Salt Spray Corrosion: >1000 hr
 Pressure: 60 bars

DRAWINGS

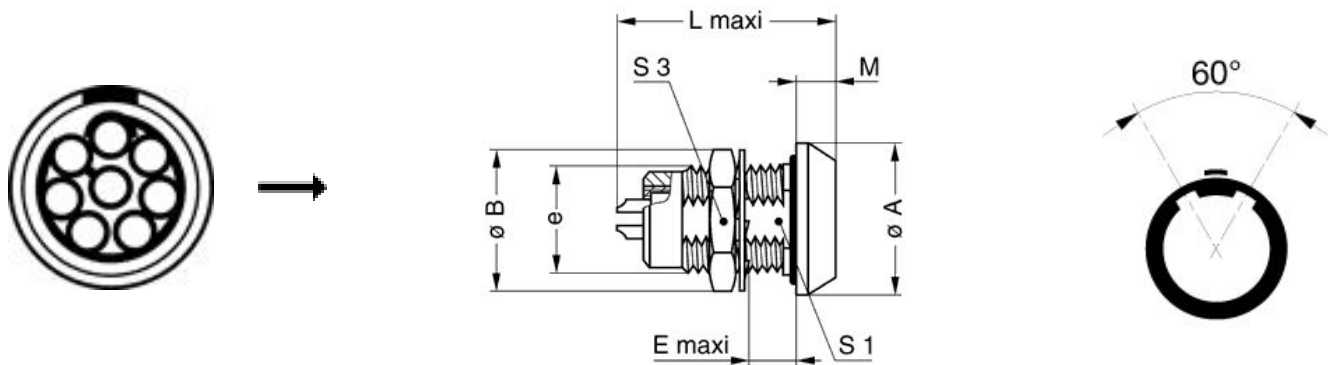

Dimensions













	A	B	E	L	M	S1	S3	e
mm.	18	16	7	26.6	4.5	10.5	14	M12x1.0
in.	0,71	0,63	0,28	1,05	0,18	0,41	0,55	

RECOMMENDED BY LEMO

LEMO products and services are provided "as is". LEMO makes no warranties or representations with regard to LEMO product & services or use of them, express, implied or statutory, including for accuracy, completeness, or security. The user is fully responsible for his products and applications using LEMO components.

Tools

Cables

CMN.08.T22.059QGC	TPR	Grey	
CMN.08.T22.059QGZE	TPR (medical)	Grey	
CMN.08.T26.042QGZE	TPR (medical)	Grey	
108220	PVC	Black	
108240	PTFE	White	
108260	PTFE	White	
16080	PVC	Grey	
180240	PVC	Black	
180260	PVC	Black	
280250	PVC	Grey	
335990	PVC	Black	
335991	PVC	Black	
42265	PVC	Yellow	
80140	PVC	Grey	
8050	PVC	Black	
8280	PVC	Black	

LEMO products and services are provided "as is". LEMO makes no warranties or representations with regard to LEMO product & services or use of them, express, implied or statutory, including for accuracy, completeness, or security. The user is fully responsible for his products and applications using LEMO components.

X-ON Electronics

Largest Supplier of Electrical and Electronic Components

Click to view similar products for [Circular Push Pull Connectors](#) category:

Click to view products by [LEMO](#) manufacturer:

Other Similar products are found below :

[6407-249V-11273P](#) [6408-201V-13273](#) [6408-202V-13343](#) [6408-202V-17343](#) [EZG.0B.309.CLN](#) [FFA.2S.310.ZLA](#) [FGA.1B.307.CYCD72Z](#)
[FGJ.1B.304.CLLD76](#) [FGJ.1B.306.CWLD72](#) [FGJ.3B.304.CYMD10Z](#) [FGJ.3B.304.CYMD82Z](#) [PCS.01.250.DLLE24](#) [PHG.0K.305.CYMC40Z](#)
[PHG.1K.308.CLLK85](#) [PKG.M0.6BL.LZ](#) [PLC.M1.0SL.LA](#) [GMA.10.290.DN](#) [GMA.3B.090.DA](#) [PRG.M0.6GL.LC52GZ](#) [PSA.1S.275.CTLC66](#)
[ABF.1S.250.NTA](#) [133020F](#) [1331ER193MZ](#) [1332M107MZ](#) [DTS26Z19-32JA-LC](#) [DTS26Z19-32SA](#) [DTS26Z19-32SA-LC](#) [DTS26Z23-55HA](#)
[DTS26Z23-55HA-LC](#) [DTS26Z23-55JA-LC](#) [EAJ.1B.306.CWA](#) [ECG.XB.312.CLL](#) [1589430-2](#) [EEA.0B.305.CLN](#) [EEA.0B.309.CLL](#)
[ELF.00.250.NTL](#) [ERA.01.250.DLL](#) [BRR.2S.200.PZVG](#) [HR10A-P](#) [CAH.M34.SLL.C72GZ](#) [CAJ.M34.SLL.C72GZ](#) [300500](#) [ESB.00.303.NLL](#)
[EXG.0B.309.HLN](#) [FFB.1S.250.CLAC27](#) [FGA.2B.306.CYCD92](#) [FGA.2B.306.CYCD92Z](#) [FGA.XB.312.CLAD72](#) [FGJ.1B.302.CYMD62](#)
[FGJ.3B.308.CLLD72Z](#)