

## SUMMARY

### # Wires

Low voltage 10



*Image is for illustrative purpose only*

Series	2B
Termination type	Female solder
IP rating	68
AWG wire size	30.00 - 22.00
Cable Ø	0.00 - 0.00 mm
Status	active
Matching parts	<a href="#">FGG.2B.310.CLAD42Z</a>

### Download

[Request a quote](#)

[Catalog](#)

## TECHNICAL DETAILS

### Mechanics

Shell Style/Model	HG*: Fixed receptacle, nut fixing, watertight or vacuum-tight
Keying	1 key (alpha=0, plug: male contacts, receptacle: female contacts)
Housing Material	Brass (chrome plated [SAE AMS 2460]) shell and collet nut, nickel plated [SAE AMS QQ N 290] brass latch sleeve and mid pieces
Variant	PV : Watertight / Vacuum-tested
Weight	20.52 g

### Performance

Configuration	2B.310 : 10 Low Voltage
Insulator	L: PEEK (UL 94 / V-0/1.5)
Rated Current	8 Amps

### Specifications

Contact Type:	Solder
Contact Dia.:	0.9 mm (0.035in)
Bucket Dia.:	0.8 mm (0.031in)
Max. Solid Conductor:	0.34 mm <sup>2</sup> (AWG 22)
Max. Stranded Conductor:	0.34 mm <sup>2</sup> (AWG 22)
R (max):	4.8 mOhm

LEMO products and services are provided "as is". LEMO makes no warranties or representations with regard to LEMO product & services or use of them, express, implied or statutory, including for accuracy, completeness, or security. The user is fully responsible for his products and applications using LEMO components.

Vtest (contact-shell): 1300 V (AC), 1840 V (DC)  
 Vtest (contact-contact): 1450 V (AC), 2050 V (DC)

## Others

Endurance (Shell): 5000  
 Temp (min / max): -20°C / +80°C  
 Humidity (max): <=95% [at 60 deg C / 140 F]  
 Vibration: 15 g [10 Hz - 2000 Hz]  
 Shock Resistance: 100 g [ 6 ms]  
 Climatical Category: 20/80/21  
 Shielding (min): 75 dB (10 MHz)  
 Shielding (min): 40 dB (1 GHz)  
 R leak (He) (max): 0.0000001 mbar\*l/s (if vacuum-tested)  
 Salt Spray Corrosion: >1000 hr  
 Pressure: 40 bars

## DRAWINGS

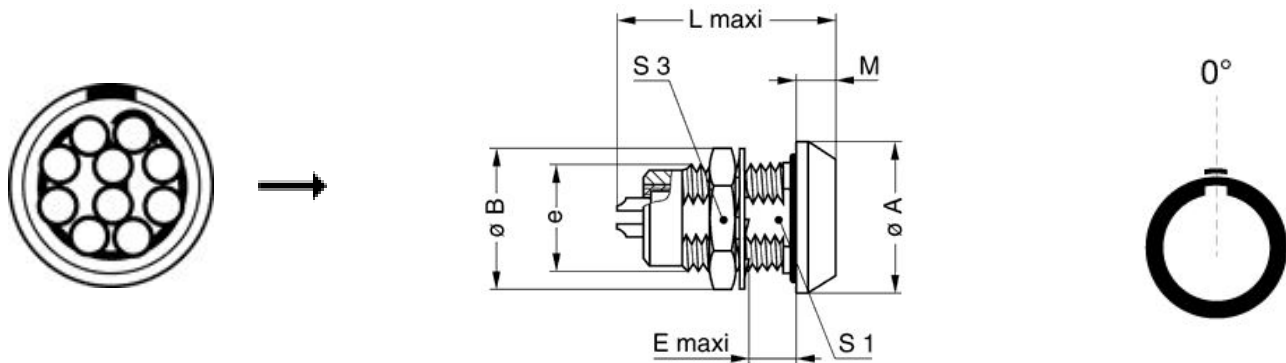

## Dimensions













	A	B	E	L	M	S1	S3	e
mm.	20	19.5	8	31.6	4	13.5	17	M15x1.0
in.	0,79	0,77	0,31	1,24	0,16	0,53	0,67	

## RECOMMENDED BY LEMO

LEMO products and services are provided "as is". LEMO makes no warranties or representations with regard to LEMO product & services or use of them, express, implied or statutory, including for accuracy, completeness, or security. The user is fully responsible for his products and applications using LEMO components.

## Tools

## Cables

CMN.10.T22.068QGZE	TPR (medical)	Grey	
CMN.10.T28.052PGZE		Grey	
CMN.10.T28.052PNZE			
CMN.10.T28.053QGZE	TPR (medical)	Grey	
110220	PVC	Black	
110240	PTFE	White	
110260	PTFE	White	
110280	PVC	Black	
210140	PVC	Grey	
210240	PVC	Black	
210250	PVC	Grey	
210260	PVC	Black	

LEMO products and services are provided "as is". LEMO makes no warranties or representations with regard to LEMO product & services or use of them, express, implied or statutory, including for accuracy, completeness, or security. The user is fully responsible for his products and applications using LEMO components.

## X-ON Electronics

Largest Supplier of Electrical and Electronic Components

*Click to view similar products for [Circular Push Pull Connectors](#) category:*

*Click to view products by [LEMO](#) manufacturer:*

Other Similar products are found below :

[6407-249V-11273P](#) [6408-201V-13273](#) [6408-202V-13343](#) [6408-202V-17343](#) [EZG.0B.309.CLN](#) [FFA.2S.310.ZLA](#) [FGA.1B.307.CYCD72Z](#)  
[FGJ.1B.304.CLLD76](#) [FGJ.1B.306.CWLD72](#) [FGJ.3B.304.CYMD10Z](#) [FGJ.3B.304.CYMD82Z](#) [PCS.01.250.DLLE24](#) [PHG.0K.305.CYMC40Z](#)  
[PHG.1K.308.CLLK85](#) [PKG.M0.6BL.LZ](#) [PLC.M1.0SL.LA](#) [GMA.10.290.DN](#) [GMA.3B.090.DA](#) [PRG.M0.6GL.LC52GZ](#) [PSA.1S.275.CTLC66](#)  
[ABF.1S.250.NTA](#) [133020F](#) [1331ER193MZ](#) [1332M107MZ](#) [DTS26Z19-32JA-LC](#) [DTS26Z19-32SA](#) [DTS26Z19-32SA-LC](#) [DTS26Z23-55HA](#)  
[DTS26Z23-55HA-LC](#) [DTS26Z23-55JA-LC](#) [EAJ.1B.306.CWA](#) [ECG.XB.312.CLL](#) [1589430-2](#) [EEA.0B.305.CLN](#) [EEA.0B.309.CLL](#)  
[ELF.00.250.NTL](#) [ERA.01.250.DLL](#) [BRR.2S.200.PZVG](#) [HR10A-P](#) [CAH.M34.SLL.C72GZ](#) [CAJ.M34.SLL.C72GZ](#) [300500](#) [ESB.00.303.NLL](#)  
[EXG.0B.309.HLN](#) [FFB.1S.250.CLAC27](#) [FGA.2B.306.CYCD92](#) [FGA.2B.306.CYCD92Z](#) [FGA.XB.312.CLAD72](#) [FGJ.1B.302.CYMD62](#)  
[FGJ.3B.308.CLLD72Z](#)