

## SUMMARY



Image is for illustrative purpose only

### # Wires

Coax 1

Series 00  
Termination type Female solder  
IP rating 68  
AWG wire size 0.00 - 0.00  
Cable Ø 0.00 - 0.00 mm  
Status active

### Download

[Request a quote](#)

[Catalog](#)

## TECHNICAL DETAILS

### Mechanics

Shell Style/Model HGP\*: Fixed receptacle, nut fixing, watertight  
Keying Circular, female  
Housing Material Brass (nickel plated [SAE AMS QQ N 290]) shell, collet nut, latch sleeve and mid pieces  
Variant PV : Watertight / Vacuum-tested  
Weight 4.35 g

### Performance

Configuration 00.250 : 1 Coax (50 Ohm)  
Insulator T: PTFE  
Rated Current 4 Amps

### Specifications

Contact Type: Coaxial 50 Ohm (Solder)  
Contact Dia.: 0.7 mm (0.028in)  
Bucket Dia.: 0.6 mm (0.024in)  
Test voltage: 2.1 kV (rms)  
R (max): 6.1 mOhm  
Vtest: 2100 V (AC), 3000 V (DC)  
□

LEMO products and services are provided "as is". LEMO makes no warranties or representations with regard to LEMO product & services or use of them, express, implied or statutory, including for accuracy, completeness, or security. The user is fully responsible for his products and applications using LEMO components.

Impedance: 50 Ohm  
VSWR:  $1.09 + 0.11 \cdot f/\text{GHz}$

## Others

Endurance (Shell): 5000 mating cycles  
Temp (min / max):  $-20^{\circ}\text{C} / +100^{\circ}\text{C}$   
F ret (min): 100 N  
R leak (He) (max):  $0.0000001 \text{ mbar}\cdot\text{l/s}$  (if vacuum-tested)  
Salt Spray Corrosion: >144 hr  
Pressure: 60 bars

## DRAWINGS

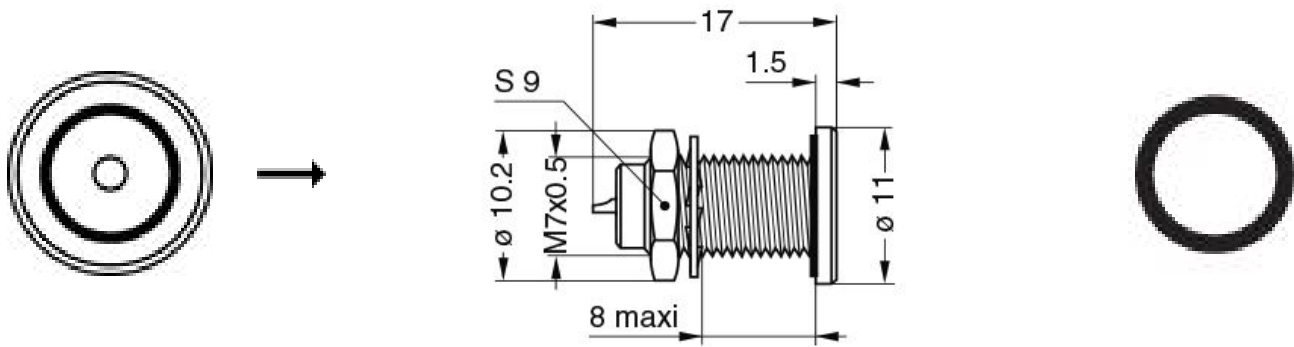

## Dimensions







	A	B	L	S3	e
mm.	11	10.2	17	9	M7x0.5
in.	0,43	0,40	0,67	0,35	

## RECOMMENDED BY LEMO

### Tools

*LEMO products and services are provided "as is". LEMO makes no warranties or representations with regard to LEMO product & services or use of them, express, implied or statutory, including for accuracy, completeness, or security. The user is fully responsible for his products and applications using LEMO components.*

## Cables

159580	PVC	Black	
17420	PVC	Black	
17450	COPOLYMER	Black	
178190	PTFE	Brown	
18000	PTFE	Brown	
18700	PTFE	White	
18800	PTFE	White	
196270	PTFE	White	
31600	PTFE	Brown	
62000	PVC	Black	
CCX.50.030.083.180B		White	
CCX.50.RG0.58AU14B	FEP	White	
CCX.50.RG1.74-U25N	PVC	Black	
CCX.50.RG1.74AU28N	PVC	Black	
CCX.50.RG1.74AU28N	PVC	Black	
CCX.50.RG1.74U25N	PVC	Black	
CCX.50.RG1.78BU18M	FEP	Brown	
CCX.50.RG1.78BU18M	PTFE	Brown	
CCX.50.RG1.88AU24B	TFE	White	
CCX.50.RG1.88AU26B	PFA	White	
CCX.50.RG1.88AU26B	PTFE	White	
CCX.50.RG1.96AU19B	PTFE	White	
CCX.50.RG1.96AU20B	PFA	White	
CCX.50.RG3.16BU26M	FEP	Brown	
CCX.50.RG3.16U28M	PTFE	Brown	
CCX.75.040.195327G	PVC	Grey	
CCX.75.RG0.59BU62N	PVC	Black	
CCX.75.RG1.79BU26M	FEP	Brown	
CCX.75.RG1.87AU26B	PFA	White	
CCX.75.RG1.87AU27B	PTFE	White	
CCX.93.RG0.62AU62N	PVC	Black	
CCX.95.RG1.80BU36M	PTFE	Brown	
CCX.95.RG1.95AU37B	PFA	White	

LEMO products and services are provided "as is". LEMO makes no warranties or representations with regard to LEMO product & services or use of them, express, implied or statutory, including for accuracy, completeness, or security. The user is fully responsible for his products and applications using LEMO components.

## X-ON Electronics

Largest Supplier of Electrical and Electronic Components

*Click to view similar products for [Circular Push Pull Connectors](#) category:*

*Click to view products by [LEMO](#) manufacturer:*

Other Similar products are found below :

[6407-249V-11273P](#) [6408-201V-13273](#) [6408-202V-13343](#) [6408-202V-17343](#) [EZG.0B.309.CLN](#) [FFA.2S.310.ZLA](#) [FGA.1B.307.CYCD72Z](#)  
[FGJ.1B.304.CLLD76](#) [FGJ.1B.306.CWLD72](#) [FGJ.3B.304.CYMD10Z](#) [FGJ.3B.304.CYMD82Z](#) [PCS.01.250.DLLE24](#) [PHG.0K.305.CYMC40Z](#)  
[PHG.1K.308.CLLK85](#) [PKG.M0.6BL.LZ](#) [PLC.M1.0SL.LA](#) [GMA.10.290.DN](#) [GMA.3B.090.DA](#) [PRG.M0.6GL.LC52GZ](#) [PSA.1S.275.CTLC66](#)  
[ABF.1S.250.NTA](#) [133020F](#) [1331ER193MZ](#) [1332M107MZ](#) [DTS26Z19-32JA-LC](#) [DTS26Z19-32SA](#) [DTS26Z19-32SA-LC](#) [DTS26Z23-55HA](#)  
[DTS26Z23-55HA-LC](#) [DTS26Z23-55JA-LC](#) [EAJ.1B.306.CWA](#) [ECG.XB.312.CLL](#) [1589430-2](#) [EEA.0B.305.CLN](#) [EEA.0B.309.CLL](#)  
[ELF.00.250.NTL](#) [ERA.01.250.DLL](#) [BRR.2S.200.PZVG](#) [HR10A-P](#) [CAH.M34.SLL.C72GZ](#) [CAJ.M34.SLL.C72GZ](#) [300500](#) [ESB.00.303.NLL](#)  
[EXG.0B.309.HLN](#) [FFB.1S.250.CLAC27](#) [FGA.2B.306.CYCD92](#) [FGA.2B.306.CYCD92Z](#) [FGA.XB.312.CLAD72](#) [FGJ.1B.302.CYMD62](#)  
[FGJ.3B.308.CLLD72Z](#)