

SUMMARY

Wires

Low voltage 2



Image is for illustrative purpose only

Series 0F
Termination type Female crimp
IP rating 67
AWG wire size 24.00 - 20.00
Cable Ø 3.80 - 9.00 mm
Status active
Matching parts [FGN.0F.302.XLC](#)

Download

[Request a quote](#)

[Catalog](#)

TECHNICAL DETAILS

Mechanics

Shell Style/Model PH*: Straight receptacle
Keying 3 keys (beta=165, gamma=30, plug: male contacts, receptacle: female contacts)
Housing Material Aluminium (nickel plated [SAE AMS QQ N 290], anthracite color) shell and nut, other pieces bronze/brass
Weight 5.33 g

Performance

Configuration 0F.302 : 2 Low Voltage
Insulator L: PEEK (UL 94 / V-0/1.5)
Rated Current 10 Amps

Specifications

Contact Type: Crimp
Contact Retention: 30 N
Contact Dia.: 0.9 mm (0.035in)
Bucket Dia.: 1.1 mm (0.043in)
Min. Conductor: 0.25 mm² (AWG 24)
Max. Conductor: 0.5 mm² (AWG 20)
R (max): 4.8 mOhm
Vtest (contact-shell): 1200 V (AC), 1700 V (DC)

LEMO products and services are provided "as is". LEMO makes no warranties or representations with regard to LEMO product & services or use of them, express, implied or statutory, including for accuracy, completeness, or security. The user is fully responsible for his products and applications using LEMO components.

Vtest (contact-contact): 1450 V (AC), 2100 V (DC)

Others

Endurance (Shell): 1000 mating cycles
Temp (min / max): -15°C / +200°C
Humidity (max): <=95% [at 60 deg C / 140 F]
Vibration: 15 g [10 Hz - 2000 Hz]
Shock Resistance: 100 g [6 ms]
Climatical Category: 15/200/21 (Aluminium shell)
Salt Spray Corrosion: max. 48 hr

DRAWINGS

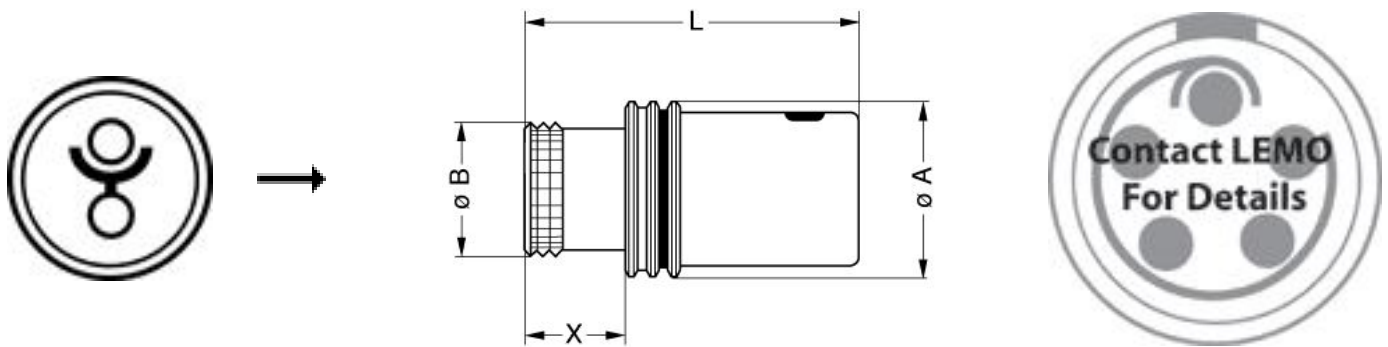

Dimensions

	A	B	L	X
mm.	12	9	26.7	8
in.	0,47	0,35	1,05	0,31

RECOMMENDED BY LEMO

Tools























Crimp Tool: [DPC.91.701.V](#)

Crimp settings: AWG/Selector = 20-22-24/6-5-5

LEMO products and services are provided "as is". LEMO makes no warranties or representations with regard to LEMO product & services or use of them, express, implied or statutory, including for accuracy, completeness, or security. The user is fully responsible for his products and applications using LEMO components.

Positionner: [DCE.91.090.BVM](#)
 Extractor: [DCF.93.090.4LT](#)
 Replacement contact: EGG.0B.660.ZZM

Cables

CMN.02.T20.047PGZE		Grey	
CMN.02.T20.047PNZE			
CMN.02.T20.048QGZE	TPR (medical)	Grey	
102080	PVC	Grey	
120184	PVC	Black	
120240	PVC	Black	
120250	PVC	Grey	
120500	PVC	Grey	
120501	PVC	Grey	
120751	PVC	Grey	
20140	PVC	Grey	
20140	PVC	Grey	
20142	PVC	Red	
20143	PVC	Green	
20144	PVC	Black	
20145	PVC	Yellow	
20146	PVC	Black	
20260	PVC	Black	
20264	PVC	Black	
20266	PVC	Violet	
220750	PVC	Grey	
2221	PVC	Black	
2280	PVC	Black	
4082	PVC	Grey	

LEMO products and services are provided "as is". LEMO makes no warranties or representations with regard to LEMO product & services or use of them, express, implied or statutory, including for accuracy, completeness, or security. The user is fully responsible for his products and applications using LEMO components.

X-ON Electronics

Largest Supplier of Electrical and Electronic Components

Click to view similar products for [Circular Push Pull Connectors](#) category:

Click to view products by [LEMO](#) manufacturer:

Other Similar products are found below :

[6407-249V-11273P](#) [6408-201V-13273](#) [6408-202V-13343](#) [6408-202V-17343](#) [EZG.0B.309.CLN](#) [FFA.2S.310.ZLA](#) [FGA.1B.307.CYCD72Z](#)
[FGJ.1B.304.CLLD76](#) [FGJ.1B.306.CWLD72](#) [FGJ.3B.304.CYMD10Z](#) [FGJ.3B.304.CYMD82Z](#) [PCS.01.250.DLLE24](#) [PHG.0K.305.CYMC40Z](#)
[PHG.1K.308.CLLK85](#) [PKG.M0.6BL.LZ](#) [PLC.M1.0SL.LA](#) [GMA.10.290.DN](#) [GMA.3B.090.DA](#) [PRG.M0.6GL.LC52GZ](#) [PSA.1S.275.CTLC66](#)
[ABF.1S.250.NTA](#) [133020F](#) [1331ER193MZ](#) [1332M107MZ](#) [DTS26Z19-32JA-LC](#) [DTS26Z19-32SA](#) [DTS26Z19-32SA-LC](#) [DTS26Z23-55HA](#)
[DTS26Z23-55HA-LC](#) [DTS26Z23-55JA-LC](#) [EAJ.1B.306.CWA](#) [ECG.XB.312.CLL](#) [1589430-2](#) [EEA.0B.305.CLN](#) [EEA.0B.309.CLL](#)
[ELF.00.250.NTL](#) [ERA.01.250.DLL](#) [BRR.2S.200.PZVG](#) [HR10A-P](#) [CAH.M34.SLL.C72GZ](#) [CAJ.M34.SLL.C72GZ](#) [300500](#) [ESB.00.303.NLL](#)
[EXG.0B.309.HLN](#) [FFB.1S.250.CLAC27](#) [FGA.2B.306.CYCD92](#) [FGA.2B.306.CYCD92Z](#) [FGA.XB.312.CLAD72](#) [FGJ.1B.302.CYMD62](#)
[FGJ.3B.308.CLLD72Z](#)