

SUMMARY

Wires

Low voltage 4

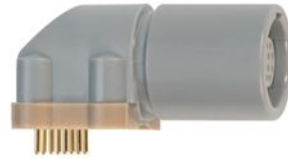

Image is for illustrative purpose only

Series	1P
Termination type	Female print PCB
IP rating	50
AWG wire size	0.00 - 0.00
Cable Ø	0.00 - 0.00 mm
Status	active
Matching parts	PAG.M0.4GL.AC39G

Download

- [Request a quote](#)
- [PCB Eagle Pattern](#)
- [PCB Altium Pattern](#)
- [PCB KiCad Pattern](#)
- [Catalog](#)

TECHNICAL DETAILS

Mechanics

Shell Style/Model	PP*: Elbow receptacle key (G) or keys (A,B,C) for printed circuit
Keying	1 key (alpha=0; Plug: male contact; Receptacle: female contact)
Housing Material	PSU (Polysulfone), gray
Weight	5.87 g

Performance

Configuration	1P.M04 : 4 Low Voltage
Insulator	G: PSU gray
Rated Current	8 Amps

Specifications

Contact Type: Print (straight)
Contact Dia.: 0.9 mm (0.0354in)
R (max): 4.5 mOhm
Test voltage (kV rms) Contact-contact: 1.2
Air clearance min.: 1.2 mm
Creepage distance min.: 1.2 mm

Others

LEMO products and services are provided "as is". LEMO makes no warranties or representations with regard to LEMO product & services or use of them, express, implied or statutory, including for accuracy, completeness, or security. The user is fully responsible for his products and applications using LEMO components.

Endurance (Shell): >2000 mating cycles
 Temp (min / max): -50°C / +150°C
 F ret (min): 50 N
 F ret (max): 150 N
 Steam sterilization: > 100 times (with potting on rear connection)

DRAWINGS

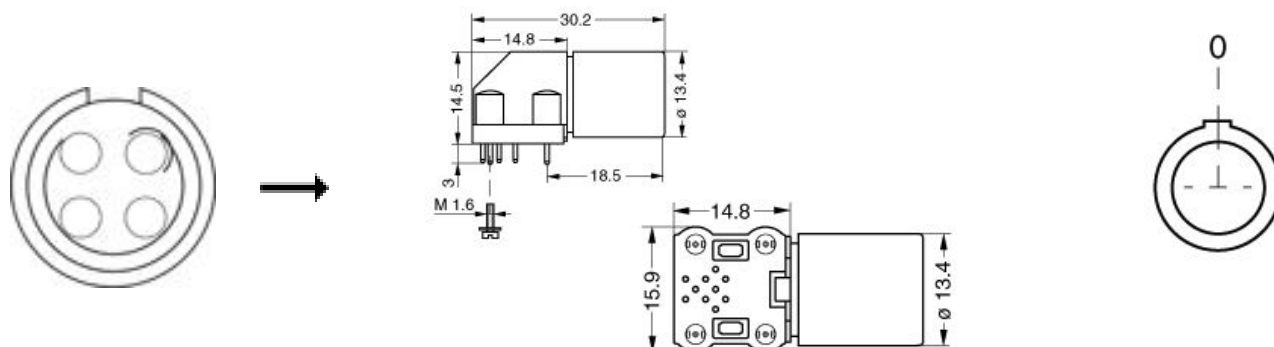

Dimensions

	A	B	H	L	M
mm.	13.4	15.9	17.5	30.2	14.8
in.	0,53	0,63	0,69	1,19	0,58

RECOMMENDED BY LEMO

Tools

LEMO products and services are provided "as is". LEMO makes no warranties or representations with regard to LEMO product & services or use of them, express, implied or statutory, including for accuracy, completeness, or security. The user is fully responsible for his products and applications using LEMO components.

X-ON Electronics

Largest Supplier of Electrical and Electronic Components

Click to view similar products for [Circular Push Pull Connectors](#) category:

Click to view products by [LEMO](#) manufacturer:

Other Similar products are found below :

[6407-249V-11273P](#) [6408-201V-13273](#) [6408-202V-13343](#) [6408-202V-17343](#) [EZG.0B.309.CLN](#) [FFA.2S.310.ZLA](#) [FGA.1B.307.CYCD72Z](#)
[FGJ.1B.304.CLLD76](#) [FGJ.1B.306.CWLD72](#) [FGJ.3B.304.CYMD10Z](#) [FGJ.3B.304.CYMD82Z](#) [PCS.01.250.DLLE24](#) [PHG.0K.305.CYMC40Z](#)
[PHG.1K.308.CLLK85](#) [PKG.M0.6BL.LZ](#) [PLC.M1.0SL.LA](#) [GMA.10.290.DN](#) [GMA.3B.090.DA](#) [PRG.M0.6GL.LC52GZ](#) [PSA.1S.275.CTLC66](#)
[ABF.1S.250.NTA](#) [133020F](#) [1331ER193MZ](#) [1332M107MZ](#) [DTS26Z19-32JA-LC](#) [DTS26Z19-32SA](#) [DTS26Z19-32SA-LC](#) [DTS26Z23-55HA](#)
[DTS26Z23-55HA-LC](#) [DTS26Z23-55JA-LC](#) [EAJ.1B.306.CWA](#) [ECG.XB.312.CLL](#) [1589430-2](#) [EEA.0B.305.CLN](#) [EEA.0B.309.CLL](#)
[ELF.00.250.NTL](#) [ERA.01.250.DLL](#) [BRR.2S.200.PZVG](#) [HR10A-P](#) [CAH.M34.SLL.C72GZ](#) [CAJ.M34.SLL.C72GZ](#) [300500](#) [ESB.00.303.NLL](#)
[EXG.0B.309.HLN](#) [FFB.1S.250.CLAC27](#) [FGA.2B.306.CYCD92](#) [FGA.2B.306.CYCD92Z](#) [FGA.XB.312.CLAD72](#) [FGJ.1B.302.CYMD62](#)
[FGJ.3B.308.CLLD72Z](#)