

D35SB10 Thru D35SB100

High Current Glass Passivated Molding Single-Phase Bridge Rectifier

Reverse Voltage 100 to 1000V Forward Current 35 A

FEATURES

- Plastic Package has Underwriters Laboratory Flammability Classification 94V-0
- High current capacity with small package
- Glass passivated chip junctions
- ESD HBM Classification 3A
- Superior thermal conductivity
- High IFSM



1. Maximum & Thermal Characteristics Ratings at 25°C ambient temperature unless otherwise specified.

Parameter Symbol		Symbol	D35SB10	D35SB20	D35SB40	D35SB60	D35SB80	D35SB100	Unit
Maximum repetitive voltage		VRRM	100	200	400	600	800	1000	V
Maximum RMS Voltage		VRMS	70	140	280	420	560	700	V
Maximum DC Blocking Voltage		VDC	100	200	400	600	800	1000	V
Maximum DC reverse current TA=25 °C		IR	5						μA
at rated DC blocking voltage TA=125°C			500						
Maximum average forward rectified output current at	With heatsink Tc=100°C ⁽¹⁾	Io	35						A
	Without heatsink Ta=25°C ⁽²⁾		10						A
Peak forward surge current 8.3ms single half sine-wave superimposed on rated load		IFSM	400						A
Rating of fusing (t<8.3ms)		I ² t	660						A2sec
Dielectric strength terminals to case, AC 1 minute Current 1mA		Vdia	2.5						KV
Max instantaneous forward voltage at 17.5A		VF	1.05						V
Operating junction temperature		TJ	-55~150						°C
Maximum thermal on P.C.B. without heat-sink		RθJA	22						°C/W
resistance per leg on Al plate heat-sink		RθJC	1.3						
Storage temperature		Tstg	-55~150						°C
Mounting torque		Tor	Rating Torque : 0.8 (Suggests 0.45~0.65)						N.m

Notes:

- (1) Unit case mounted on aluminum plate heatsink
(2) Units mounted on P.C.B. without heatsink

D35SB10 Thru D35SB100

2. Ratings and Characteristic Curves ($T_A = 25^\circ\text{C}$ unless otherwise noted)

Fig. 1 Derating Curve

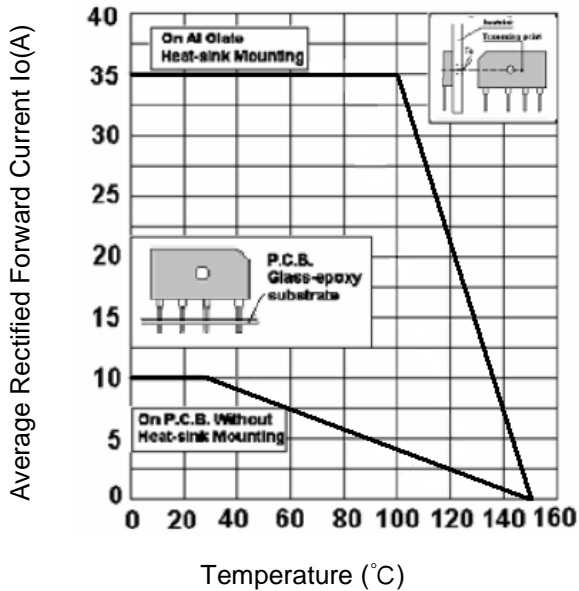

Fig.2 Typical Reverse Characteristics

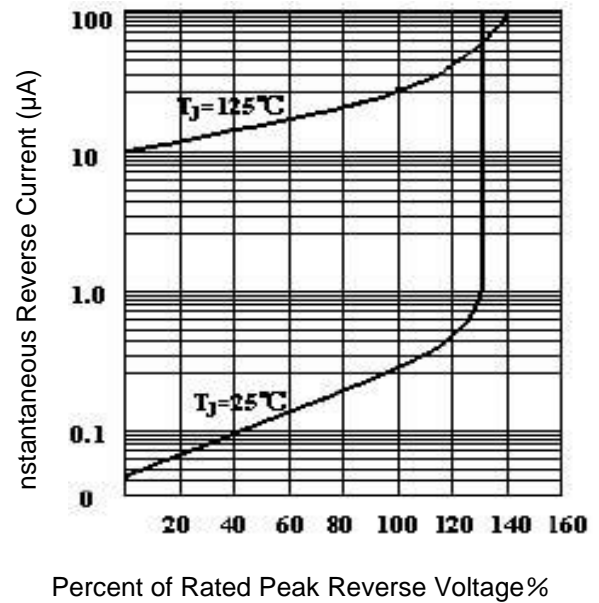

Fig.3 Forward Voltage

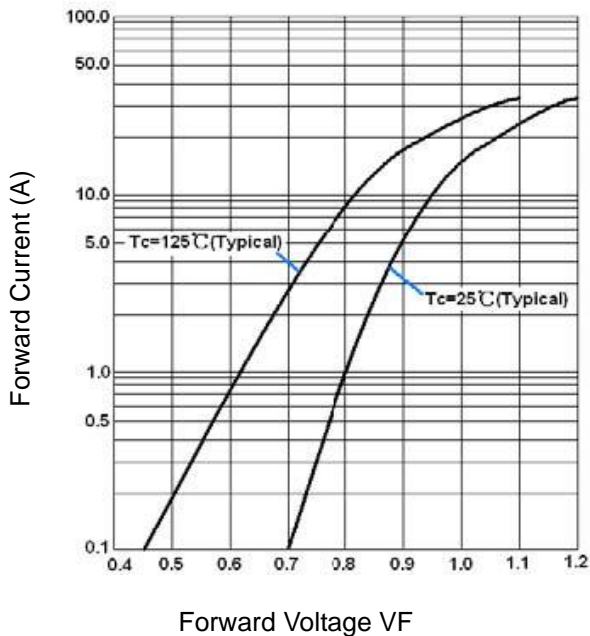
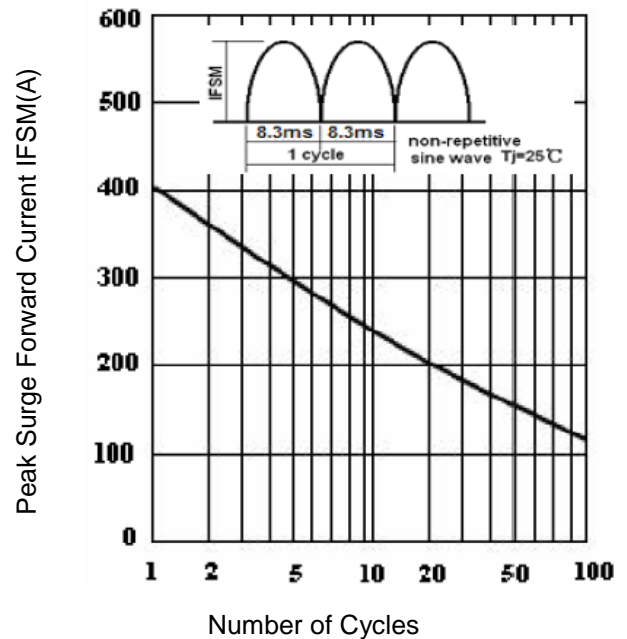
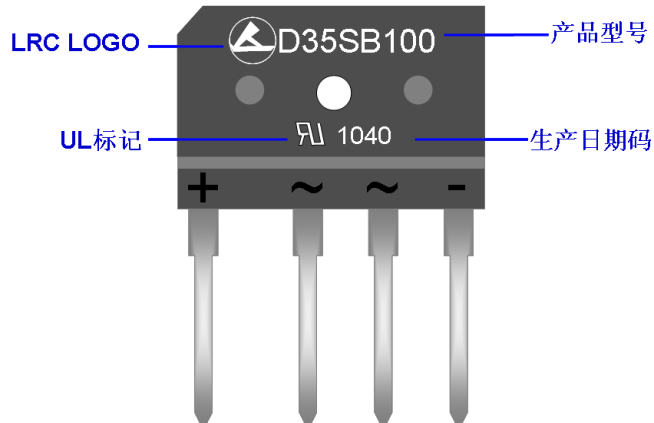

Fig.4 Peak Surge Forward Capability



D35SB10 Thru D35SB100

3. Marking Identification



Note:

生产日期码包含4位数字，例如“1040”，前两个数字“10”表示为2010年，另外二个数字“40”是指第40周，即表示该产品为2010年40周生产。

型号:

D **35** **SB** **100**

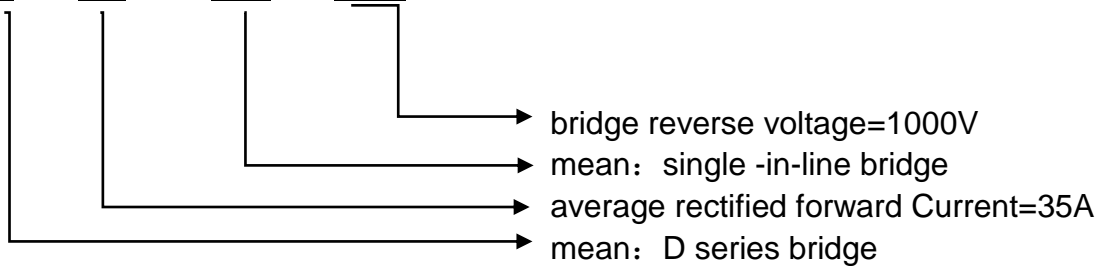

4. Dimension

Package Type D5/KBJ

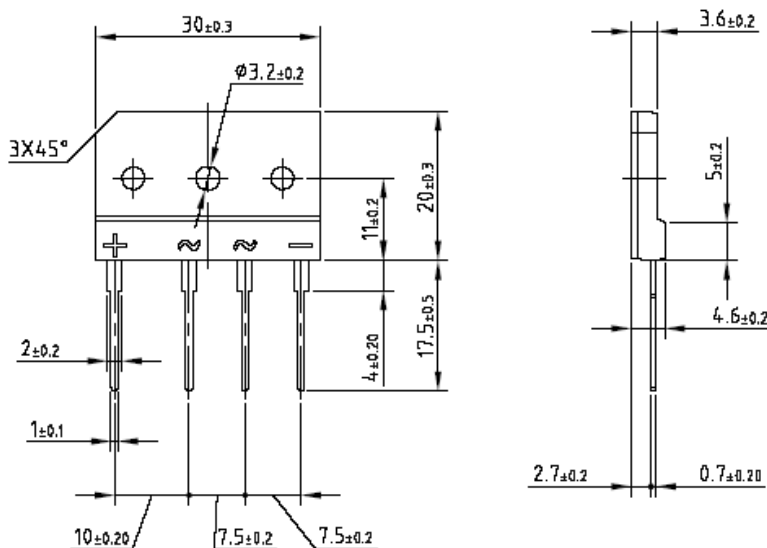

X-ON Electronics

Largest Supplier of Electrical and Electronic Components

Click to view similar products for [Bridge Rectifiers](#) category:

Click to view products by [Leshan](#) manufacturer:

Other Similar products are found below :

[MB252](#) [MB356G](#) [MB358G](#) [GBJ1504-BP](#) [GBU10B-BP](#) [GBU15K-BP](#) [GBU4A-BP](#) [GBU4D-BP](#) [DB101-BP](#) [DF01](#) [DF10SA-E345](#) [KBPC50-10S](#) [RS405GL-BP](#) [GBJ1502-BP](#) [GBU6M](#) [TB102M](#) [MB1510](#) [MB86](#) [TL401G](#) [MDA920A2](#) [TU602](#) [TU810](#) [MP5010W-BP](#) [MP501W-BP](#) [MP502-BP](#) [KBPC25-02](#) [VBO160-12NO7](#) [VS-110MT120KPBF](#) [VS-60MT80KPBF](#) [DB105-BP](#) [DF1510S](#) [VS-40MT160PAPBF](#) [GBU4G-BP](#) [GSIB15A80-E3/45](#) [DB104-BP](#) [D3SB60](#) [TB354](#) [GBJ2504-BP](#) [26MB100A](#) [B1S-G](#) [VS-40MT160KPBF](#) [VUO162-16NO7](#) [ABS10-G](#) [GBU6B-BP](#) [GBJ1508-BP](#) [BR5010-G](#) [ABS6-G](#) [B125C800G-E4/51](#) [MSB15MH-13](#) [LBS10-13](#)