

DB152 Thru DB157

High Current Glass Passivated Molding Single-Phase Bridge Rectifier

Reverse Voltage 100 to 1000V Forward Current 1.5 A

FEATURES

- Plastic Package has Underwriters Laboratory Flammability Classification 94V-0
- High current capacity with small package
- Glass passivated chip junctions
- Superior thermal conductivity
- High IFSM



1. Maximum & Thermal Characteristics Ratings at 25°C ambient temperature unless otherwise specified.

Parameter Symbol	Symbol	DB152	DB153	DB154	DB155	DB156	DB157	Unit
Maximum repetitive voltage	VRRM	100	200	400	600	800	1000	V
Maximum RMS Voltage	VRMS	70	140	280	420	560	700	V
Maximum DC Blocking Voltage	VDC	100	200	400	600	800	1000	V
Maximum DC reverse current TA=25 °C	IR	5						μA
at rated DC blocking voltage TA=125°C		500						
Average rectified forward current 60Hz Sine wave Resistance load with Ta=55°C	Io	1.5						A
Peak forward surge current 8.3ms single half sine-wave superimposed on rated load	IFSM	50						A
Max instantaneous forward voltage at 1.5A	VF	1.05						V
Current Squared Time	I ² t	10						A ² sec
Operating junction temperature	TJ	-55~150						°C
Storage temperature	Tstg	-55~150						°C

DB152 Thru DB157

2. Ratings and Characteristic Curves (TA = 25°C unless otherwise noted)

Fig. 1 Derating Curve

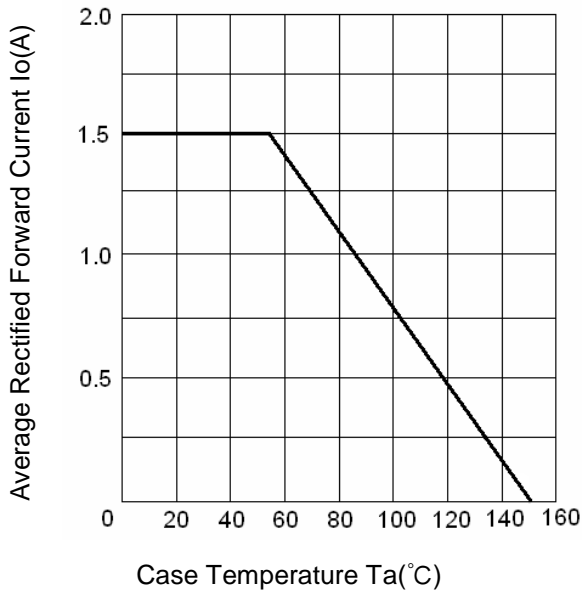

Fig.2 Typical Reverse Characteristics

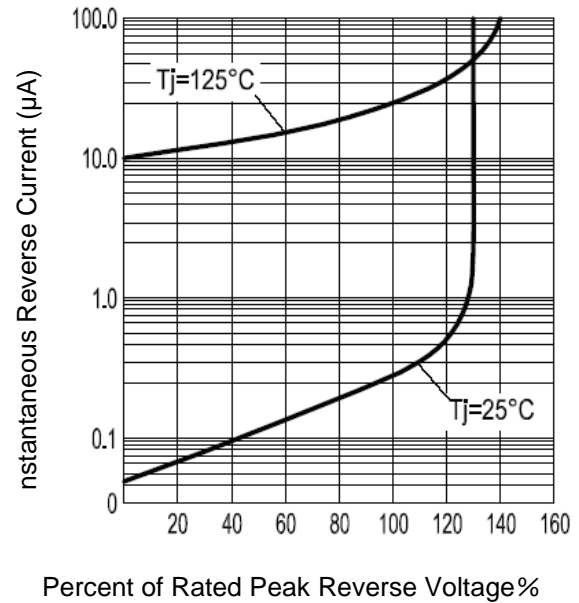

Fig.3 Forward Voltage

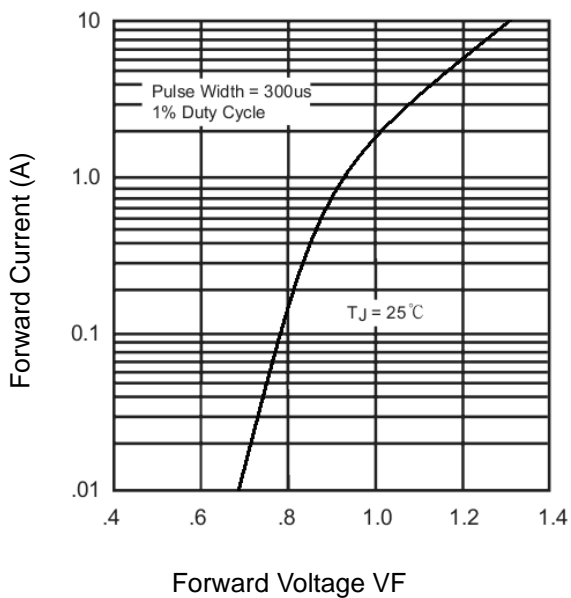
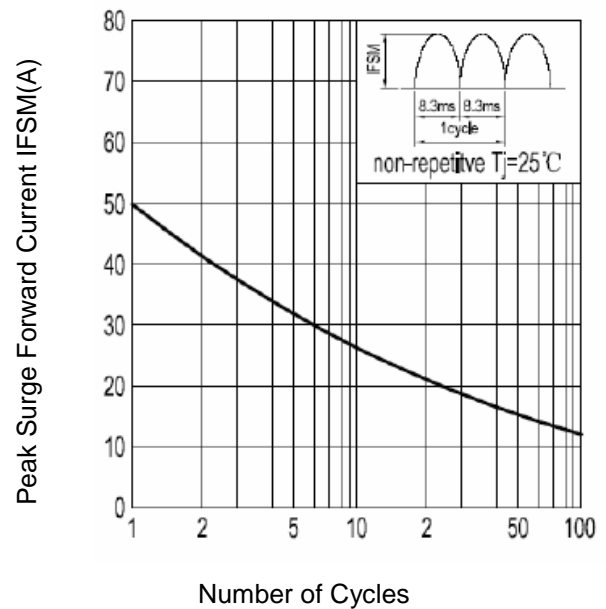
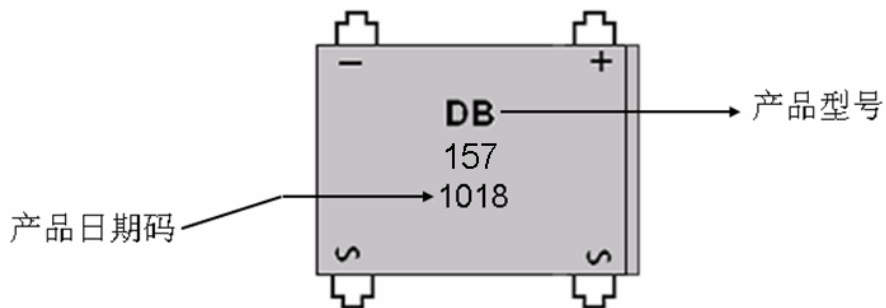

Fig.4 Peak Surge Forward Capability



DB152 Thru DB157

3. Marking Identification



Note:

生产日期码包含4位数字，例如“1018”，前两个数字“10”表示为2010年，另外二个数字“18”是指第18周，即表示该产品为2010年18周生产。

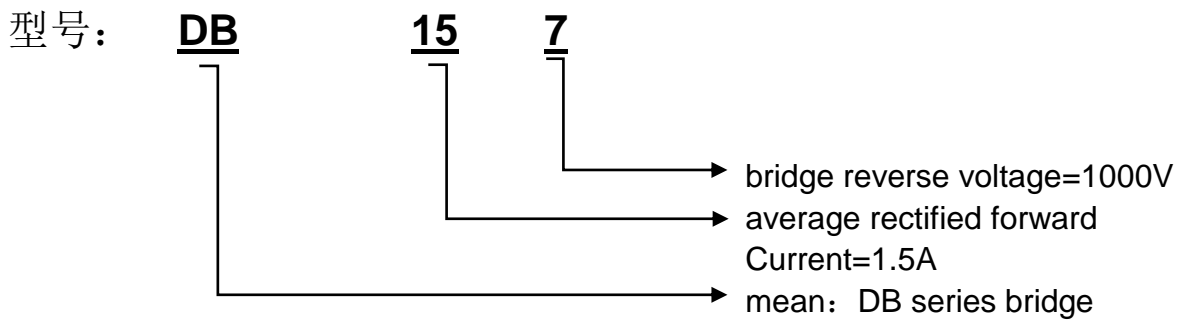

4. Dimension

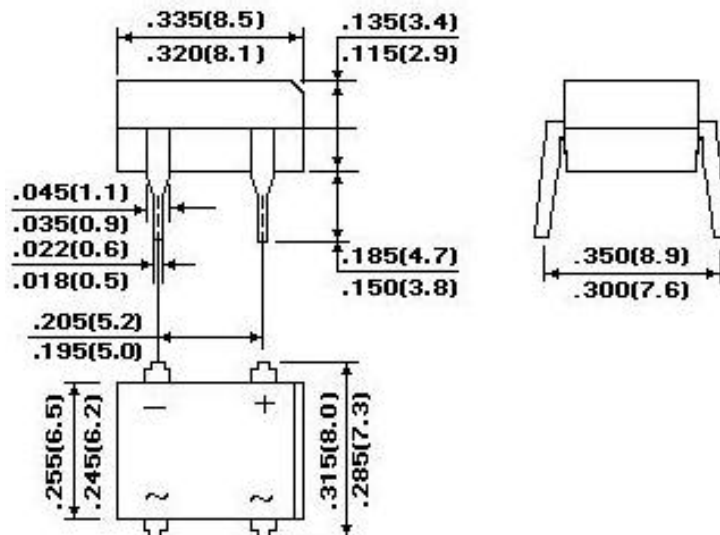

X-ON Electronics

Largest Supplier of Electrical and Electronic Components

Click to view similar products for [Bridge Rectifiers](#) category:

Click to view products by [Leshan](#) manufacturer:

Other Similar products are found below :

[MB2510](#) [MB252](#) [MB356G](#) [MB358G](#) [GBJ1504-BP](#) [GBU10B-BP](#) [GBU15K-BP](#) [GBU4A-BP](#) [GBU4D-BP](#) [GBU6B-E3/45](#) [DB101-BP](#) [DF01](#)
[DF10SA-E345](#) [BU1508-E3/45](#) [BU1510-E3/45](#) [KBPC50-10S](#) [RS405GL-BP](#) [GBJ1502-BP](#) [GBU6M](#) [GSIB1520-E3/45](#) [36MB140A](#) [TB102M](#)
[MB1510](#) [MB86](#) [TL401G](#) [MDA920A2](#) [TU602](#) [TU810](#) [MP5010W-BP](#) [MP501W-BP](#) [MP502-BP](#) [BR84DTP204](#) [BU1508-E3/51](#) [KBPC25-02](#)
[VS-110MT120KPBF](#) [VS-2KBB60](#) [VS-60MT120KPBF](#) [VS-60MT80KPBF](#) [DB105-BP](#) [DF1510S](#) [VS-40MT160PAPBF](#) [VISKBU8K-E4/51](#)
[36MT100](#) [GBU4G-BP](#) [GBU6B-E3/51](#) [DF15005S-E3/77](#) [GSIB15A80-E3/45](#) [DB104-BP](#) [D3SB60](#) [TB354](#)