

General Purpose Transistors

PNP Silicon

- Moisture Sensitivity Level: 1
- ESD Rating – Human Body Model: >4000 V
– Machine Model: >400 V
- We declare that the material of product compliance with RoHS requirements.
- S- Prefix for Automotive and Other Applications Requiring Unique Site and Control Change Requirements; AEC-Q101 Qualified and PPAP Capable.

MAXIMUM RATINGS (T_A = 25°C unless otherwise noted)

Rating	Symbol	Value	Unit
Collector-Emitter Voltage LBC856 LBC857 LBC858, LBC859	V _{CEO}	-65 -45 -30	V
Collector-Base Voltage LBC856 LBC857 LBC858, LBC859	V _{CBO}	-80 -50 -30	V
Emitter-Base Voltage	V _{EBO}	-5.0	V
Collector Current – Continuous	I _C	-100	mAdc

THERMAL CHARACTERISTICS

Characteristic	Symbol	Max	Unit
Total Device Dissipation FR-5 Board, (Note 1.) T _A = 25°C Derate above 25°C	P _D	225 1.8	mW mW/°C
Thermal Resistance, Junction to Ambient	R _{θJA}	556	°C/W
Total Device Dissipation Alumina Substrate, (Note 2.) T _A = 25°C Derate above 25°C	P _D	300 2.4	mW mW/°C
Thermal Resistance, Junction to Ambient	R _{θJA}	417	°C/W
Junction and Storage Temperature	T _J , T _{stg}	-55 to +150	°C

1. FR-5 = 1.0 x 0.75 x 0.062 in
2. Alumina = 0.4 x 0.3 x 0.024 in. 99.5% alumina.

**LBC857CLT1G
S-LBC857CLT1G
Series**

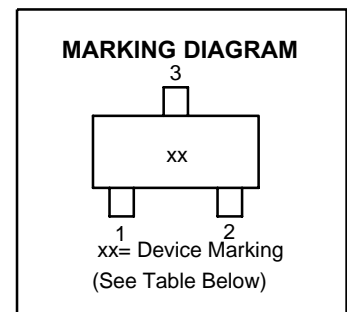
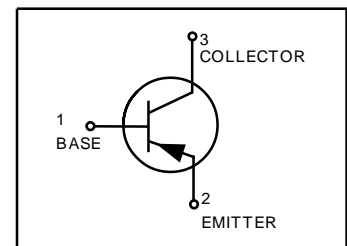
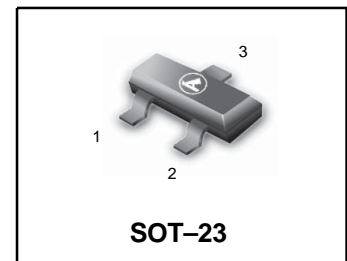

DEVICE MARKING AND ORDERING INFORMATION

Device	Marking	Package	Shipping
LBC856ALT1G S-LBC856ALT1G	3A	SOT-23	3000/Tape&Reel
LBC856ALT3G S-LBC856ALT3G	3A	SOT-23	10000/Tape&Reel
LBC856BLT1G S-LBC856BLT1G	3B	SOT-23	3000/Tape&Reel
LBC856BLT3G S-LBC856BLT3G	3B	SOT-23	10000/Tape&Reel
LBC857ALT1G S-LBC857ALT1G	3E	SOT-23	3000/Tape&Reel
LBC857ALT1G S-LBC857ALT1G	3E	SOT-23	10000/Tape&Reel
LBC857BLT1G S-LBC857BLT1G	3F	SOT-23	3000/Tape&Reel
LBC857BLT3G S-LBC857BLT3G	3F	SOT-23	10000/Tape&Reel
LBC857CLT1G S-LBC857CLT1G	3G	SOT-23	3000/Tape&Reel
LBC857CLT1G S-LBC857CLT1G	3G	SOT-23	10000/Tape&Reel
LBC858ALT1G S-LBC858ALT1G	3J	SOT-23	3000/Tape&Reel
LBC858ALT1G S-LBC858ALT1G	3J	SOT-23	10000/Tape&Reel
LBC858BLT1G S-LBC858BLT1G	3K	SOT-23	3000/Tape&Reel
LBC858BLT3G S-LBC858BLT3G	3K	SOT-23	10000/Tape&Reel
LBC858CLT1G S-LBC858CLT1G	3L	SOT-23	3000/Tape&Reel
LBC858CLT3G S-LBC858CLT3G	3L	SOT-23	10000/Tape&Reel
LBC859BLT1G S-LBC859BLT1G	4B	SOT-23	3000/Tape&Reel
LBC859BLT1G S-LBC859BLT1G	4B	SOT-23	10000/Tape&Reel
LBC859CLT1G S-LBC859CLT1G	4C	SOT-23	3000/Tape&Reel
LBC859CLT3G S-LBC859CLT3G	4C	SOT-23	10000/Tape&Reel

LBC857CLT1G Series
S-LBC857CLT1G Series

ELECTRICAL CHARACTERISTICS ($T_A = 25^\circ\text{C}$ unless otherwise noted)

Characteristic		Symbol	Min	Typ	Max	Unit
OFF CHARACTERISTICS						
Collector–Emitter Breakdown Voltage ($I_C = -10\text{ mA}$)	LBC856 Series LBC857 Series LBC858, LBC859 Series	$V_{(BR)CEO}$	-65 -45 -30	- - -	- - -	V
Collector–Emitter Breakdown Voltage ($I_C = -10\ \mu\text{A}$, $V_{EB} = 0$)	LBC856 Series LBC857 Series LBC858, LBC859 Series	$V_{(BR)CES}$	-80 -50 -30	- - -	- - -	V
Collector–Base Breakdown Voltage ($I_C = -10\ \mu\text{A}$)	LBC856 Series LBC857 Series LBC858, LBC859 Series	$V_{(BR)CBO}$	-80 -50 -30	- - -	- - -	V
Emitter–Base Breakdown Voltage ($I_E = -1.0\ \mu\text{A}$)	LBC856 Series LBC857 Series LBC858, LBC859 Series	$V_{(BR)EBO}$	-5.0 -5.0 -5.0	- - -	- - -	V
Collector Cutoff Current ($V_{CB} = -30\text{ V}$) ($V_{CB} = -30\text{ V}$, $T_A = 150^\circ\text{C}$)		I_{CBO}	- -	- -	-15 -4.0	nA μA

ON CHARACTERISTICS

DC Current Gain ($I_C = -2.0\text{ mA}$, $V_{CE} = -5.0\text{ V}$)	LBC856A, LBC857A, LBC858A LBC856B, LBC857B, LBC858B, LBC859B LBC857C, LBC858C, LBC859C	h_{FE}	125 220 420	180 290 520	250 475 800	-
Collector–Emitter Saturation Voltage ($I_C = -10\text{ mA}$, $I_B = -0.5\text{ mA}$) ($I_C = -100\text{ mA}$, $I_B = -5.0\text{ mA}$)		$V_{CE(sat)}$	- -	- -	-0.3 -0.65	V
Base–Emitter Saturation Voltage ($I_C = -10\text{ mA}$, $I_B = -0.5\text{ mA}$) ($I_C = -100\text{ mA}$, $I_B = -5.0\text{ mA}$)		$V_{BE(sat)}$	- -	-0.7 -0.9	- -	V
Base–Emitter On Voltage ($I_C = -2.0\text{ mA}$, $V_{CE} = -5.0\text{ V}$) ($I_C = -10\text{ mA}$, $V_{CE} = -5.0\text{ V}$)		$V_{BE(on)}$	-0.6 -	- -	-0.75 -0.82	V

SMALL–SIGNAL CHARACTERISTICS

Current–Gain – Bandwidth Product ($I_C = -10\text{ mA}$, $V_{CE} = -5.0\text{ Vdc}$, $f = 100\text{ MHz}$)		f_T	100	-	-	MHz
Output Capacitance ($V_{CB} = -10\text{ V}$, $f = 1.0\text{ MHz}$)		C_{ob}	-	-	4.5	pF
Noise Figure ($I_C = -0.2\text{ mA}$, $V_{CE} = -5.0\text{ Vdc}$, $R_S = 2.0\text{ k}\Omega$, $f = 1.0\text{ kHz}$, $BW = 200\text{ Hz}$)	LBC856, LBC857, LBC858 Series LBC859 Series	NF	- -	- -	10 4.0	dB

LBC857/ LBC858

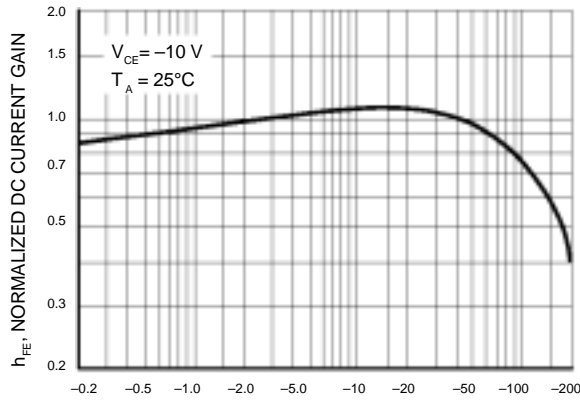

I_C , COLLECTOR CURRENT (mAdc)
Figure 1. Normalized DC Current Gain

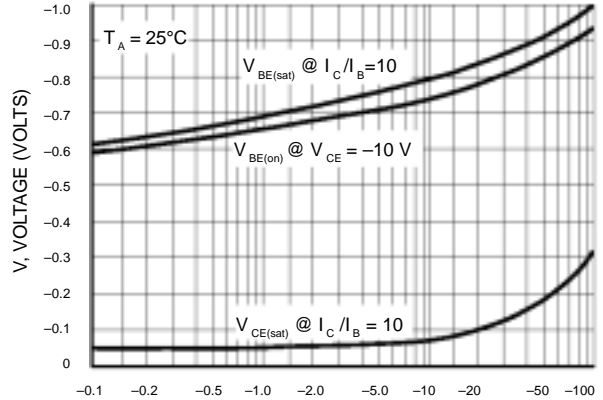

I_C , COLLECTOR CURRENT (mAdc)
Figure 2. "Saturation" and "On" Voltages

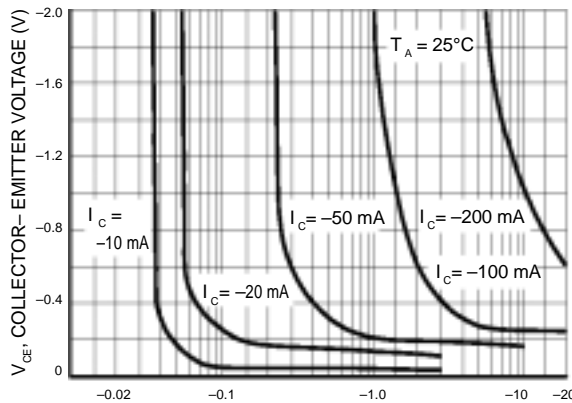

I_B , BASE CURRENT (mA)
Figure 3. Collector Saturation Region

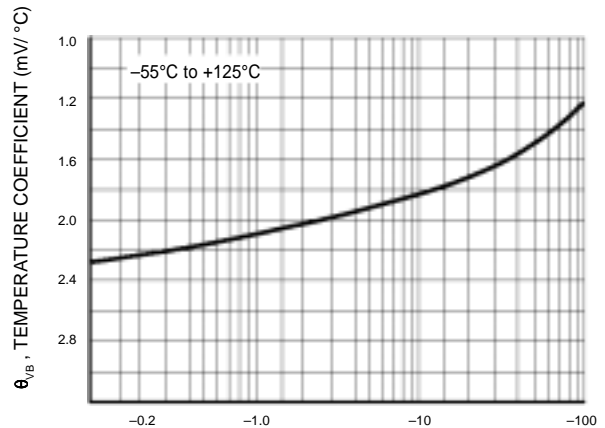

I_C , COLLECTOR CURRENT (mA)
Figure 4. Base-Emitter Temperature Coefficient

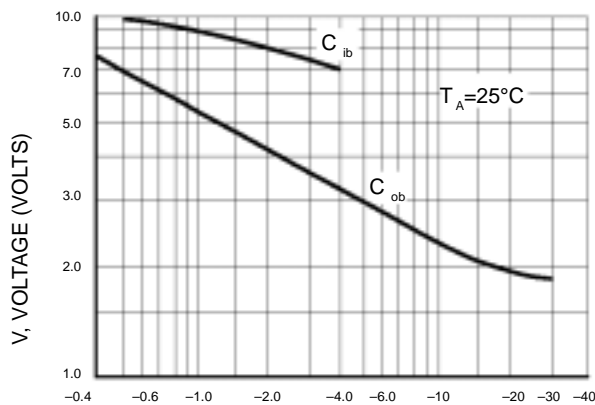

V_R , REVERSE VOLTAGE (VOLTS)
Figure 5. Capacitances

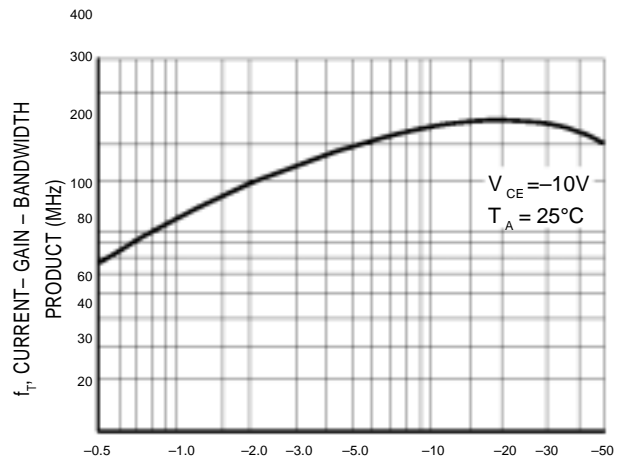

I_C , COLLECTOR CURRENT (mAdc)
Figure 6. Current-Gain - Bandwidth Product

LBC856

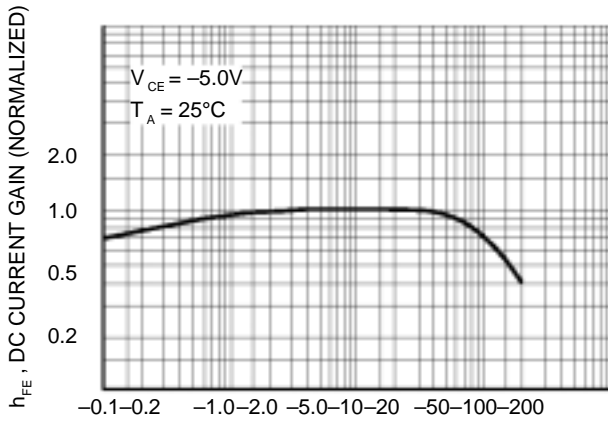

I_C , COLLECTOR CURRENT (mA)
Figure 7. DC Current Gain

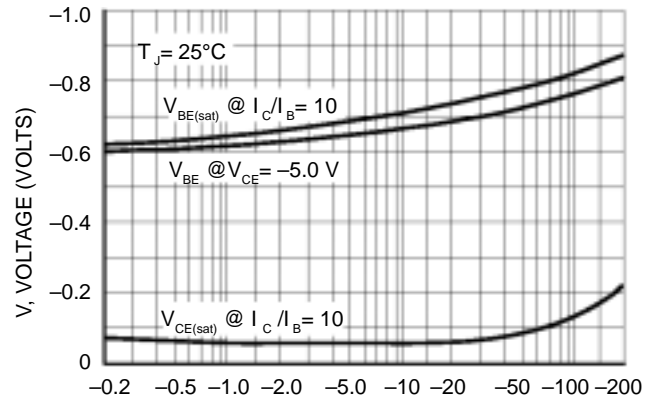

I_C , COLLECTOR CURRENT (mA)
Figure 8. "On" Voltage

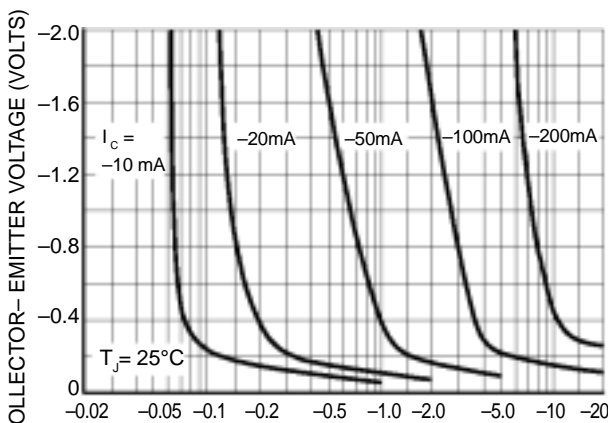

I_B , BASE CURRENT (mA)
Figure 9. Collector Saturation Region

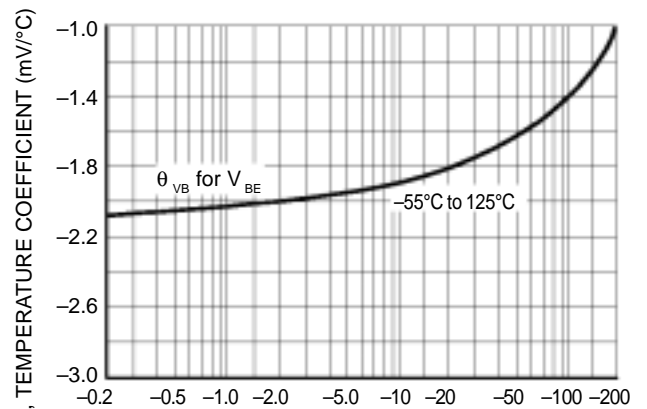

I_C , COLLECTOR CURRENT (mA)
Figure 10. Base-Emitter Temperature Coefficient

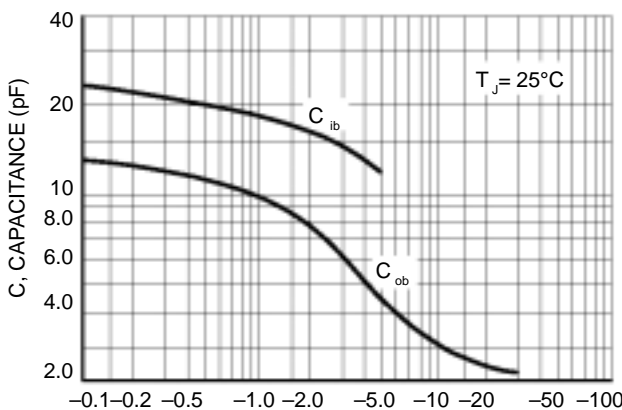

V_R , REVERSE VOLTAGE (VOLTS)
Figure 11. Capacitance

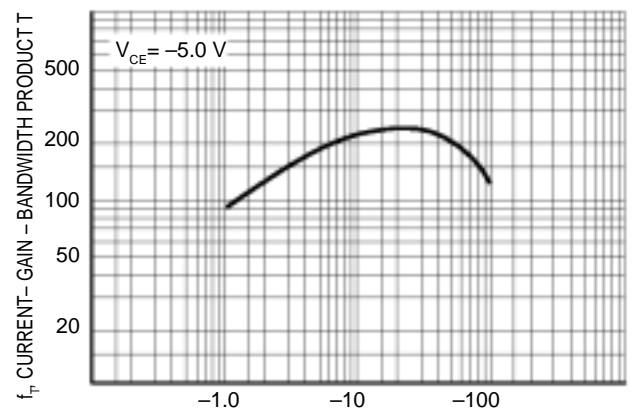

I_C , COLLECTOR CURRENT (mA)
Figure 12. Current-Gain - Bandwidth Product

LBC857CLT1G Series
S-LBC857CLT1G Series

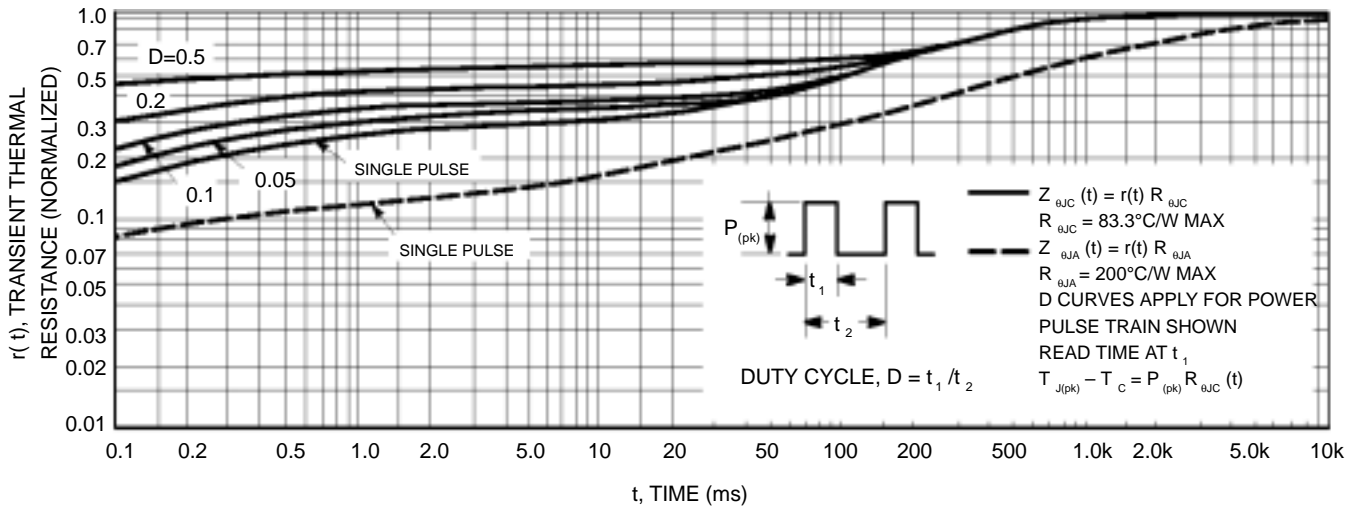

Figure 13. Thermal Response

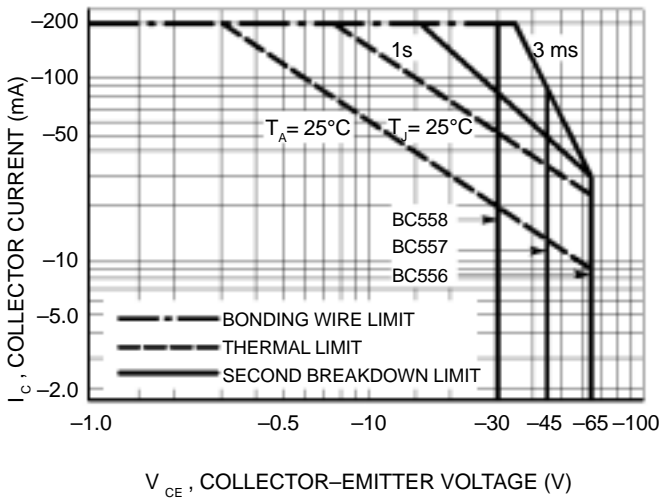
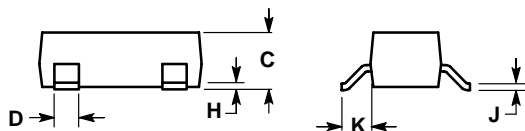
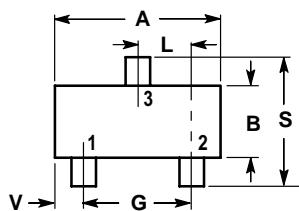

Figure 14. Active Region Safe Operating Area

The safe operating area curves indicate $I_C - V_{CE}$ limits of the transistor that must be observed for reliable operation. Collector load lines for specific circuits must fall below the limits indicated by the applicable curve.

The data of Figure 14 is based upon $T_{J(pk)} = 150^\circ\text{C}$; T_C or T_A is variable depending upon conditions. Pulse curves are valid for duty cycles to 10% provided $T_{J(pk)} \leq 150^\circ\text{C}$. $T_{J(pk)}$ may be calculated from the data in Figure 13. At high case or ambient temperatures, thermal limitations will reduce the power that can be handled to values less than the limitations imposed by the secondary breakdown.

SOT-23



NOTES:

1. DIMENSIONING AND TOLERANCING PER ANSI Y14.5M, 1982.
2. CONTROLLING DIMENSION: INCH.

DIM	INCHES		MILLIMETERS	
	MIN	MAX	MIN	MAX
A	0.1102	0.1197	2.80	3.04
B	0.0472	0.0551	1.20	1.40
C	0.0350	0.0440	0.89	1.11
D	0.0150	0.0200	0.37	0.50
G	0.0701	0.0807	1.78	2.04
H	0.0005	0.0040	0.013	0.100
J	0.0034	0.0070	0.085	0.177
K	0.0140	0.0285	0.35	0.69
L	0.0350	0.0401	0.89	1.02
S	0.0830	0.1039	2.10	2.64
V	0.0177	0.0236	0.45	0.60

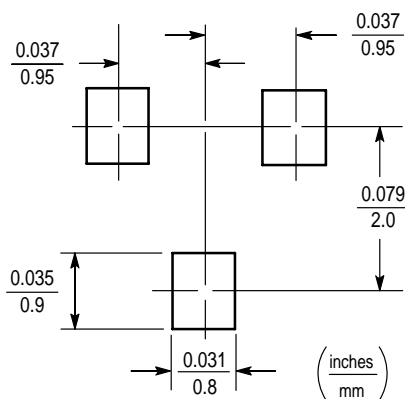

X-ON Electronics

Largest Supplier of Electrical and Electronic Components

Click to view similar products for [Bipolar Transistors - BJT category](#):

Click to view products by [Leshan manufacturer](#):

Other Similar products are found below :

[619691C](#) [MCH4017-TL-H](#) [MMBT-2369-TR](#) [BC546/116](#) [BC557/116](#) [BSW67A](#) [NJVMJD148T4G](#) [NTE123AP-10](#) [NTE153MCP](#) [NTE16](#)
[NTE195A](#) [NTE92](#) [C4460](#) [2N4401-A](#) [2N6728](#) [2SA1419T-TD-H](#) [2SA2126-E](#) [2SB1204S-TL-E](#) [2SC2712S-GR,LF](#) [2SC5488A-TL-H](#)
[2SD2150T100R](#) [SP000011176](#) [2N2907A](#) [2N3904-NS](#) [2N5769](#) [2SC2412KT146S](#) [2SD1816S-TL-E](#) [CPH6501-TL-E](#) [MCH4021-TL-E](#)
[MJE340](#) [US6T6TR](#) [NJL0281DG](#) [732314D](#) [CPH3121-TL-E](#) [CPH6021-TL-H](#) [873787E](#) [IMZ2AT108](#) [UMX21NTR](#) [MCH6102-TL-E](#)
[NJL0302DG](#) [2N3583](#) [30A02MH-TL-E](#) [NSV40301MZ4T1G](#) [NTE13](#) [NTE26](#) [NTE282](#) [NTE323](#) [NTE350](#) [NTE81](#) [STX83003-AP](#)