

# Bias Resistor Transistors

## NPN Silicon Surface Mount Transistors With Monolithic Bias Resistor Network

This new series of digital transistors is designed to replace a single device and its external resistor bias network. The BRT (Bias Resistor Transistor) contains a single transistor with a monolithic bias network consisting of two resistors; a series base resistor and a base-emitter resistor. The BRT eliminates these individual components by integrating them into a single device. The use of a BRT can reduce both system cost and board space. The device is housed in the SOT-723 package which is designed for low power surface mount applications.

- Simplifies Circuit Design
- Reduces Board Space
- Reduces Component Count
- The SOT-723 Package can be Soldered using Wave or Reflow.
- Available in 4 mm, 8000 Unit Tape & Reel
- These are Pb-Free Devices.
- S- Prefix for Automotive and Other Applications Requiring Unique Site and Control Change Requirements; AEC-Q101 Qualified and PPAP Capable.

### MAXIMUM RATINGS (T<sub>A</sub> = 25°C unless otherwise noted)

Rating	Symbol	Value	Unit
Collector-Base Voltage	V <sub>CB0</sub>	50	Vdc
Collector-Emitter Voltage	V <sub>CEO</sub>	50	Vdc
Collector Current	I <sub>C</sub>	100	mAdc

### THERMAL CHARACTERISTICS

Characteristic	Symbol	Max	Unit
Total Device Dissipation T <sub>A</sub> = 25°C Derate above 25°C	P <sub>D</sub>	260 (Note 1) 600 (Note 2) 2.0 (Note 1) 4.8 (Note 2)	mW mW/°C
Thermal Resistance – Junction-to-Ambient	R <sub>θJA</sub>	480 (Note 1) 205 (Note 2)	°C/W
Junction Temperature	T <sub>J</sub>	150	°C
Storage Temperature Range	T <sub>stg</sub>	-55 to +150	°C

1. FR-4 @ Minimum Pad
2. FR-4 @ 1.0 x 1.0 inch Pad

## LDTC114EM3T5G Series S-LDTC114EM3T5G Series

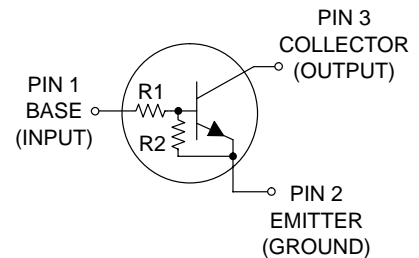
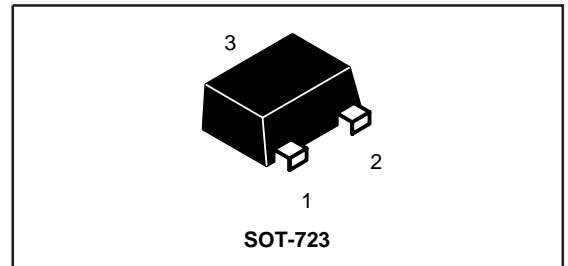

### MARKING DIAGRAM

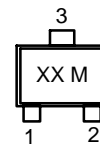

- xx = Specific Device Code  
M = Date Code

**S-LDTC114EM3T5G ;S-S-LDTC114EM3T5G  
Series**

**DEVICE MARKING AND RESISTOR VALUES**

Device		Marking	R1 (K)	R2 (K)	Package	Shipping
LDTC114EM3T5G	S-LDTC114EM3T5G	8A	10	10	SOT-723	8000/Tape & Reel
LDTC124EM3T5G	S-LDTC124EM3T5G	8B	22	22		
LDTC144EM3T5G	S-LDTC144EM3T5G	8C	47	47		
LDTC114YM3T5G	S-LDTC114YM3T5G	8D	10	47		
LDTC114TM3T5G	S-LDTC114TM3T5G	9A	10	∞		
LDTC143TM3T5G	S-LDTC143TM3T5G	8F	4.7	∞		
LDTC123EM3T5G	S-LDTC123EM3T5G	8H	2.2	2.2		
LDTC143EM3T5G	S-LDTC143EM3T5G	8J	4.7	4.7		
LDTC143ZM3T5G	S-LDTC143ZM3T5G	8K	4.7	47		
LDTC124XM3T5G	S-LDTC124XM3T5G	8L	22	47		
LDTC123JM3T5G	S-LDTC123JM3T5G	8M	2.2	47		
LDTC115EM3T5G	S-LDTC115EM3T5G	8N	100	100		
LDTC144WM3T5G	S-LDTC144WM3T5G	8P	47	22		
LDTC144TM3T5G	S-LDTC144TM3T5G	8T	47	∞		

## S-LDTC114EM3T5G ;S-S-LDTC114EM3T5G Series

**ELECTRICAL CHARACTERISTICS** ( $T_A = 25^\circ\text{C}$  unless otherwise noted)

Characteristic	Symbol	Min	Typ	Max	Unit
<b>OFF CHARACTERISTICS</b>					
Collector–Base Cutoff Current ( $V_{CB} = 50\text{ V}, I_E = 0$ )	$I_{CBO}$	–	–	100	nAdc
Collector–Emitter Cutoff Current ( $V_{CE} = 50\text{ V}, I_B = 0$ )	$I_{CEO}$	–	–	500	nAdc
Emitter–Base Cutoff Current ( $V_{EB} = 6.0\text{ V}, I_C = 0$ )	$I_{EBO}$	–	–	0.5	mAdc
LDTTC114EM3T5G		–	–	0.2	
LDTTC124EM3T5G		–	–	0.1	
LDTTC144EM3T5G		–	–	0.2	
LDTTC114YM3T5G		–	–	0.9	
LDTTC114TM3T5G		–	–	1.9	
LDTTC143TM3T5G		–	–	2.3	
LDTTC123EM3T5G		–	–	1.5	
LDTTC143EM3T5G		–	–	0.18	
LDTTC143ZM3T5G		–	–	0.13	
LDTTC124XM3T5G		–	–	0.2	
LDTTC123JM3T5G		–	–	0.05	
LDTTC115EM3T5G		–	–	0.13	
LDTTC144WM3T5G		–	–	0.2	
LDTTC144TM3T5G		–	–		
Collector–Base Breakdown Voltage ( $I_C = 10\ \mu\text{A}, I_E = 0$ )	$V_{(BR)CBO}$	50	–	–	Vdc
Collector–Emitter Breakdown Voltage (Note 3) ( $I_C = 2.0\text{ mA}, I_B = 0$ )	$V_{(BR)CEO}$	50	–	–	Vdc

**ON CHARACTERISTICS** (Note 3)

DC Current Gain ( $V_{CE} = 10\text{ V}, I_C = 5.0\text{ mA}$ )	LDTTC114EM3T5G LDTTC124EM3T5G LDTTC144EM3T5G LDTTC114YM3T5G LDTTC114TM3T5G LDTTC143TM3T5G LDTTC123EM3T5G LDTTC143EM3T5G LDTTC143ZM3T5G LDTTC124XM3T5G LDTTC123JM3T5G LDTTC115EM3T5G LDTTC144WM3T5G LDTTC144TM3T5G	$h_{FE}$	35 60 80 80 160 160 8.0 15 80 80 80 80 80 80 160	60 100 140 140 350 350 15 30 200 150 140 150 140 350	– – – – – – – – – – – – – – –	
Collector–Emitter Saturation Voltage ( $I_C = 10\text{ mA}, I_B = 0.3\text{ mA}$ ) ( $I_C = 10\text{ mA}, I_B = 5\text{ mA}$ ) ( $I_C = 10\text{ mA}, I_B = 1\text{ mA}$ )	LDTTC123EM3T5G LDTTC143TM3T5G/LDTTC114TM3T5G/ LDTTC143EM3T5G/LDTTC143ZM3T5G/ LDTTC124XM3T5G/LDTTC144TM3T5G	$V_{CE(sat)}$	–	–	0.25	Vdc
Output Voltage (on) ( $V_{CC} = 5.0\text{ V}, V_B = 2.5\text{ V}, R_L = 1.0\text{ k}\Omega$ )	LDTTC114EM3T5G LDTTC124EM3T5G LDTTC114YM3T5G LDTTC114TM3T5G LDTTC143TM3T5G LDTTC123EM3T5G LDTTC143EM3T5G LDTTC143ZM3T5G LDTTC124XM3T5G LDTTC123JM3T5G	$V_{OL}$	– – – – – – – – – –	– – – – – – – – – –	0.2 0.2 0.2 0.2 0.2 0.2 0.2 0.2 0.2 0.2	Vdc
( $V_{CC} = 5.0\text{ V}, V_B = 3.5\text{ V}, R_L = 1.0\text{ k}\Omega$ )	LDTTC144EM3T5G LDTTC144TM3T5G		– –	– –	0.2 0.2	
( $V_{CC} = 5.0\text{ V}, V_B = 5.5\text{ V}, R_L = 1.0\text{ k}\Omega$ )	LDTTC115EM3T5G		–	–	0.2	
( $V_{CC} = 5.0\text{ V}, V_B = 4.0\text{ V}, R_L = 1.0\text{ k}\Omega$ )	LDTTC144WM3T5G		–	–	0.2	

3. Pulse Test: Pulse Width < 300  $\mu\text{s}$ , Duty Cycle < 2.0%.

## S-LDTC114EM3T5G ;S-S-LDTC114EM3T5G Series

**ELECTRICAL CHARACTERISTICS** ( $T_A = 25^\circ\text{C}$  unless otherwise noted)

Characteristic	Symbol	Min	Typ	Max	Unit
<b>ON CHARACTERISTICS</b> (Note 4)					
Characteristic	Symbol	Min	Typ	Max	Unit
Output Voltage (off) ( $V_{CC} = 5.0\text{ V}$ , $V_B = 0.5\text{ V}$ , $R_L = 1.0\text{ k}\Omega$ ) ( $V_{CC} = 5.0\text{ V}$ , $V_B = 0.25\text{ V}$ , $R_L = 1.0\text{ k}\Omega$ ) LDTC143TM3T5G LDTC143ZM3T5G LDTC114TM3T5G LDTC144TM3T5G	$V_{OH}$	4.9	–	–	Vdc
Input Resistor LDTC114EM3T5G LDTC124EM3T5G LDTC144EM3T5G LDTC114YM3T5G LDTC114TM3T5G LDTC143TM3T5G LDTC123EM3T5G LDTC143EM3T5G LDTC143ZM3T5G LDTC124XM3T5G LDTC123JM3T5G LDTC115EM3T5G LDTC144WM3T5G LDTC144TM3T5G	R1	7.0 15.4 32.9 7.0 7.0 3.3 1.5 3.3 3.3 15.4 1.54 70 32.9 32.9	10 22 47 10 10 4.7 2.2 4.7 4.7 22 2.2 100 47 47	13 28.6 61.1 13 13 6.1 2.9 6.1 6.1 28.6 2.86 130 61.1 61.1	k $\Omega$
Resistor Ratio LDTC114EM3T5G/LDTC124EM3T5G/ LDTC144EM3T5G/LDTC115EM3T5G LDTC114YM3T5G LDTC143TM3T5G/LDTC114TM3T5G/LDTC144TM3T5G LDTC123EM3T5G/LDTC143EM3T5G LDTC143ZM3T5G LDTC124XM3T5G LDTC123JM3T5G LDTC144WM3T5G	$R_1/R_2$	0.8 0.17 – 0.8 0.055 0.38 0.038 1.7	1.0 0.21 – 1.0 0.1 0.47 0.047 2.1	1.2 0.25 – 1.2 0.185 0.56 0.056 2.6	
Input voltage ( $V_{CC} = 5.0\text{ V}$ , $I_O = 100\mu\text{A}$ ) LDTC123JM3T5G	$V_{I(off)}$	–	–	0.5	V
Input voltage ( $V_O = 0.3\text{ V}$ , $I_O = 5\text{ mA}$ ) LDTC123JM3T5G	$V_{I(on)}$	1.1	–	–	V

4. Pulse Test: Pulse Width < 300  $\mu\text{s}$ , Duty Cycle < 2.0%.

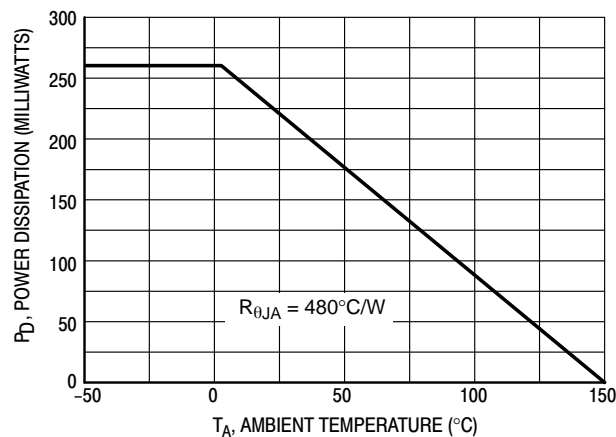

Figure 1. Derating Curve

## S-LDTC114EM3T5G ;S-S-LDTC114EM3T5G Series

### TYPICAL ELECTRICAL CHARACTERISTICS – LDTC114EM3T5G

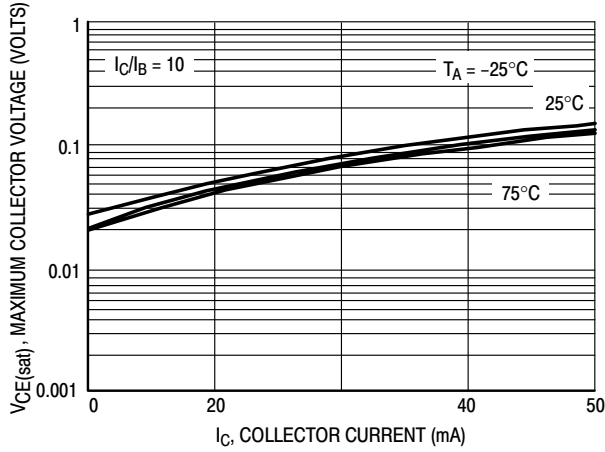

Figure 2.  $V_{CE(sat)}$  versus  $I_C$

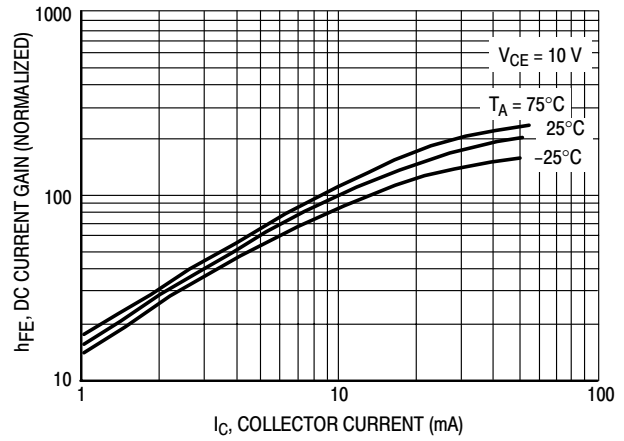

Figure 3. DC Current Gain

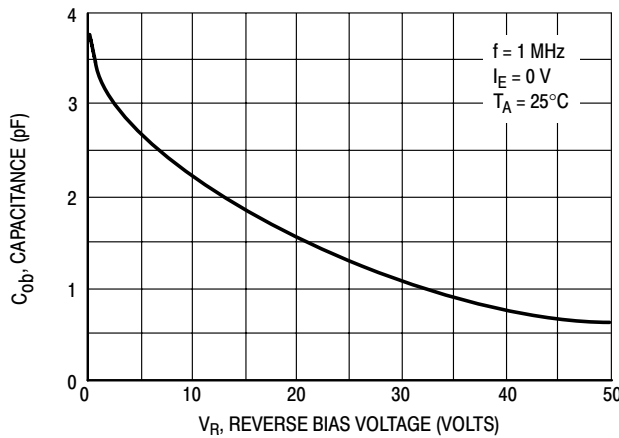

Figure 4. Output Capacitance

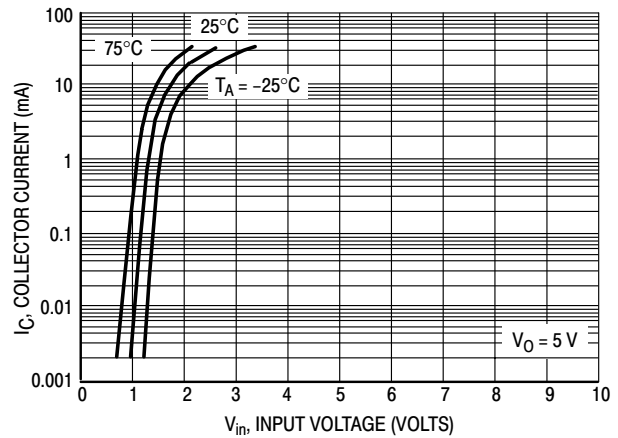

Figure 5. Output Current versus Input Voltage

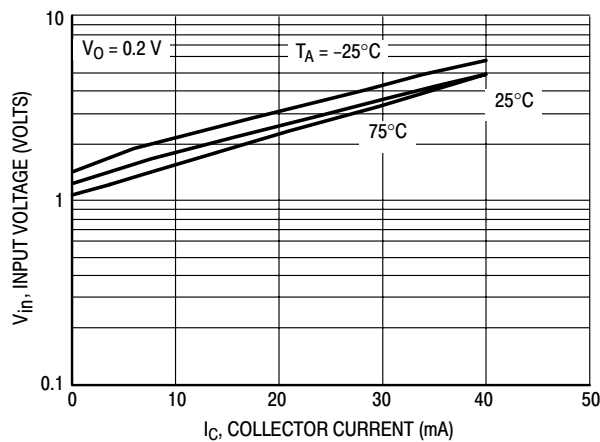

Figure 6. Input Voltage versus Output Current

## S-LDTC114EM3T5G ;S-S-LDTC114EM3T5G Series

### TYPICAL ELECTRICAL CHARACTERISTICS – LDTC124EM3T5G

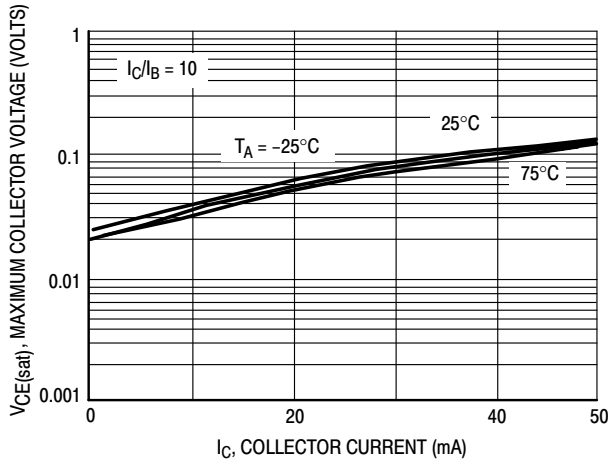

Figure 7.  $V_{CE(sat)}$  versus  $I_C$

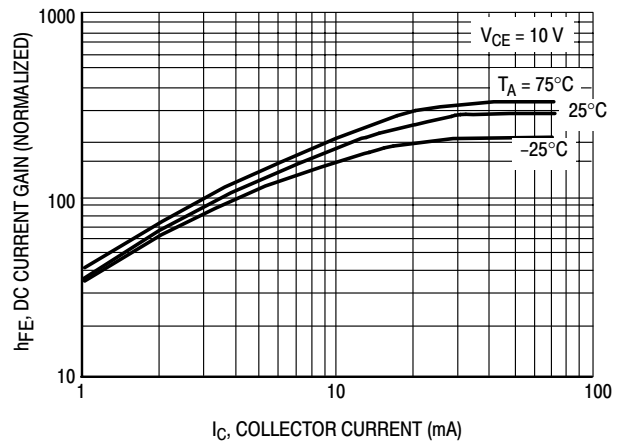

Figure 8. DC Current Gain

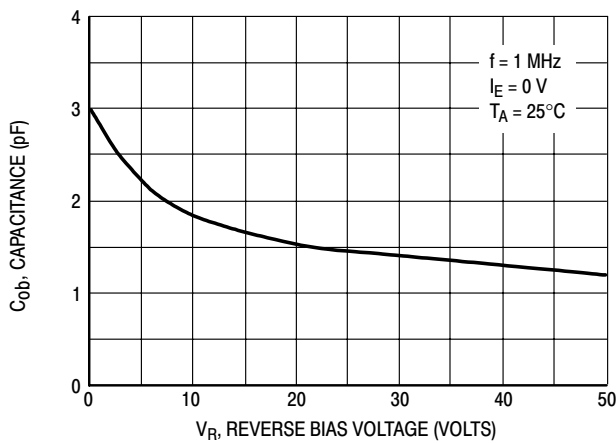

Figure 9. Output Capacitance

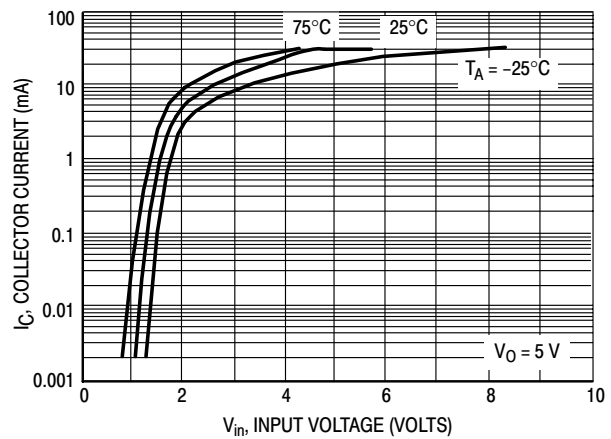

Figure 10. Output Current versus Input Voltage

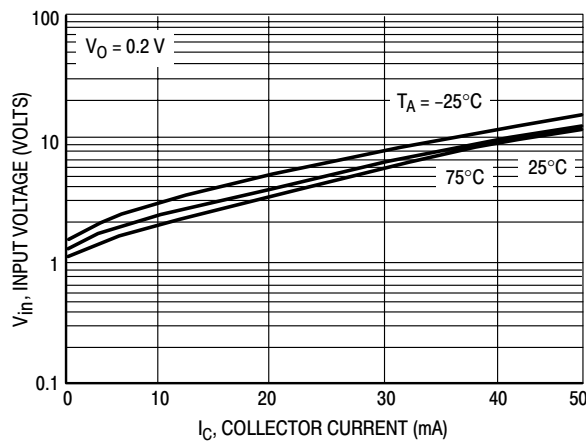

Figure 11. Input Voltage versus Output Current

## S-LDTC114EM3T5G ;S-S-LDTC114EM3T5G Series

### TYPICAL ELECTRICAL CHARACTERISTICS – LDTC144EM3T5G

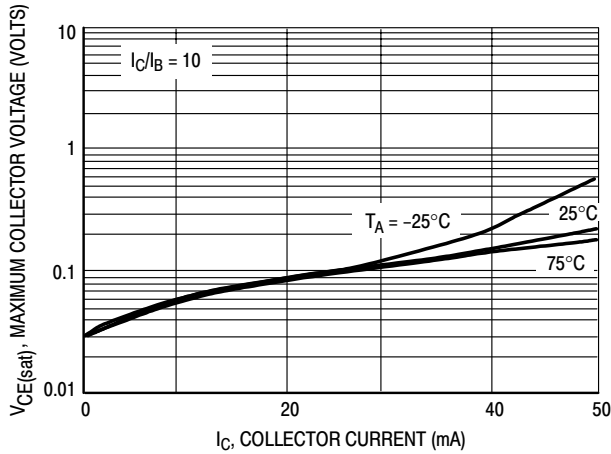

Figure 12.  $V_{CE(sat)}$  versus  $I_C$

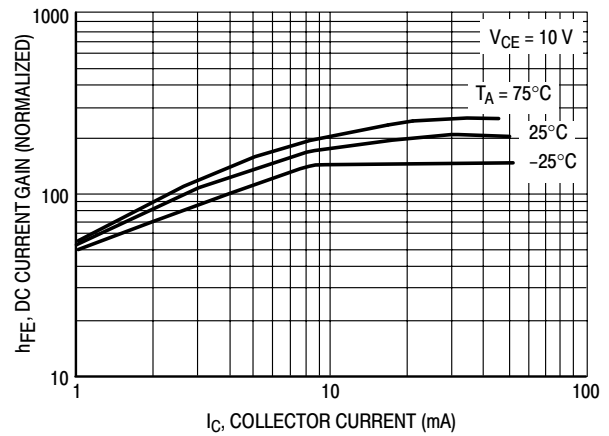

Figure 13. DC Current Gain

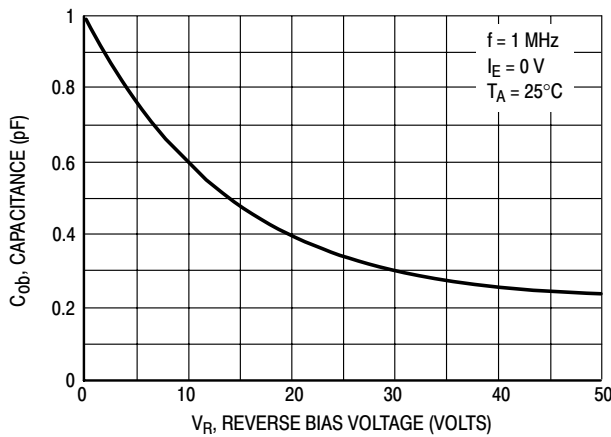

Figure 14. Output Capacitance

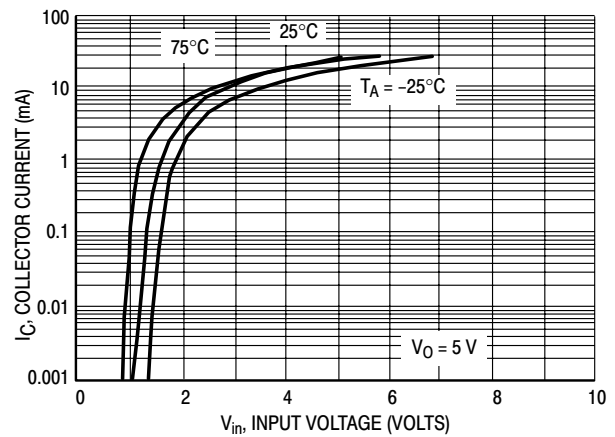

Figure 15. Output Current versus Input Voltage

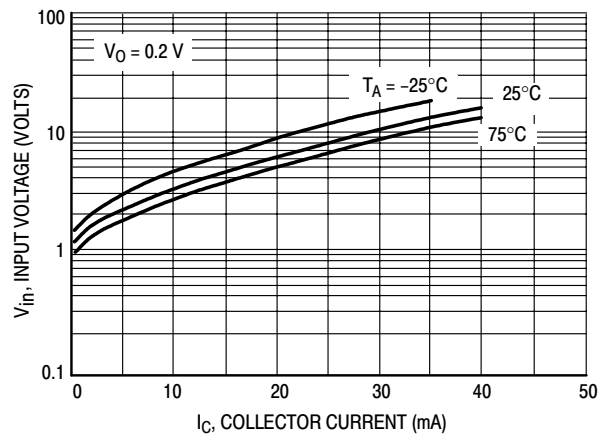

Figure 16. Input Voltage versus Output Current

## S-LDTC114EM3T5G ;S-S-LDTC114EM3T5G Series

### TYPICAL ELECTRICAL CHARACTERISTICS – LDTC114YM3T5G

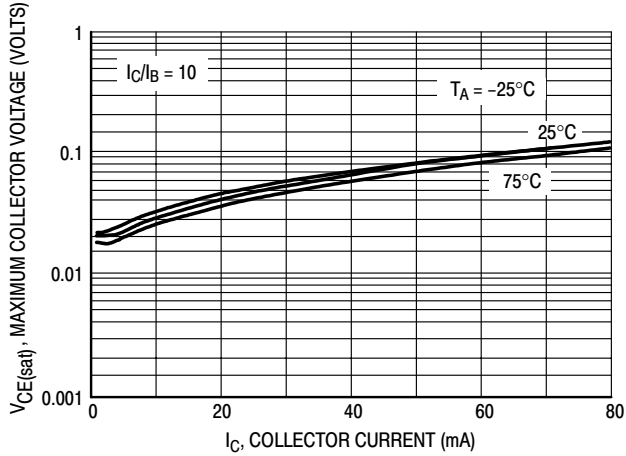

Figure 17.  $V_{CE(sat)}$  versus  $I_C$

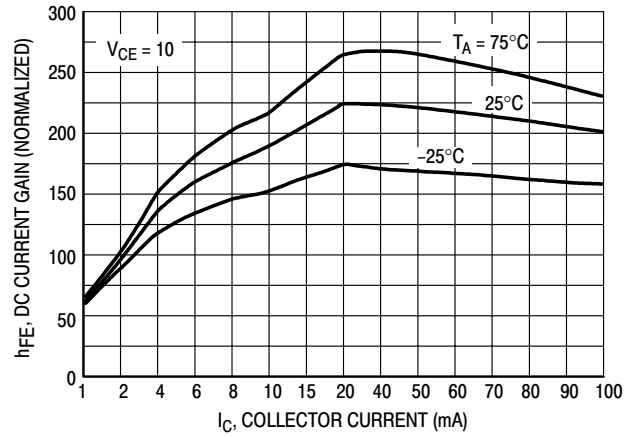

Figure 18. DC Current Gain

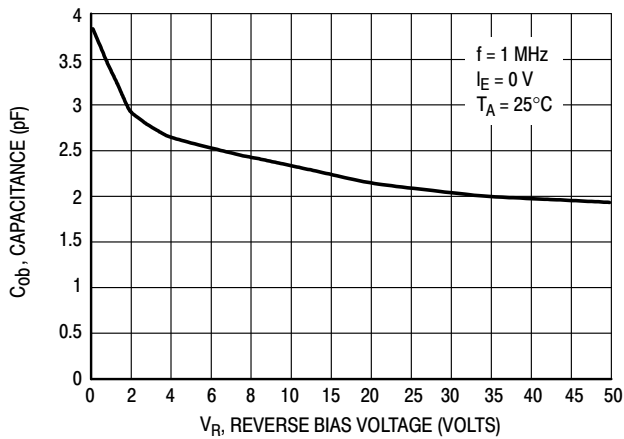

Figure 19. Output Capacitance

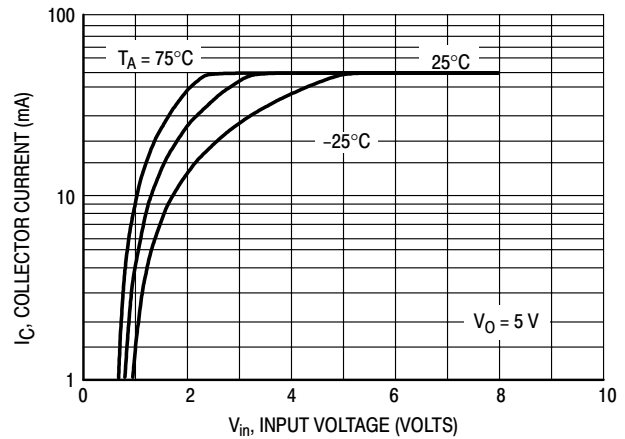

Figure 20. Output Current versus Input Voltage

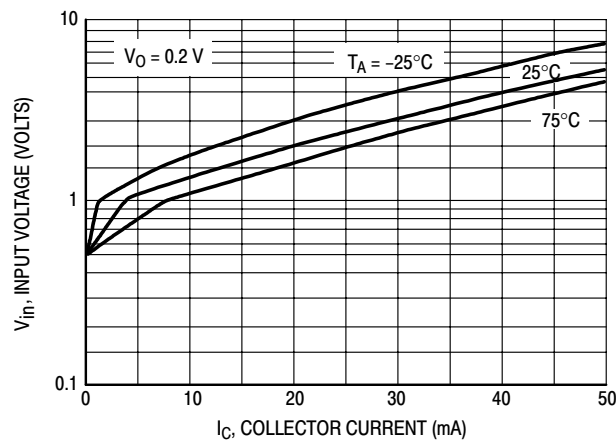

Figure 21. Input Voltage versus Output Current



# S-LDTC114EM3T5G ; S-S-LDTC114EM3T5G Series

## TYPICAL ELECTRICAL CHARACTERISTICS – LDTC143ZM3T5G

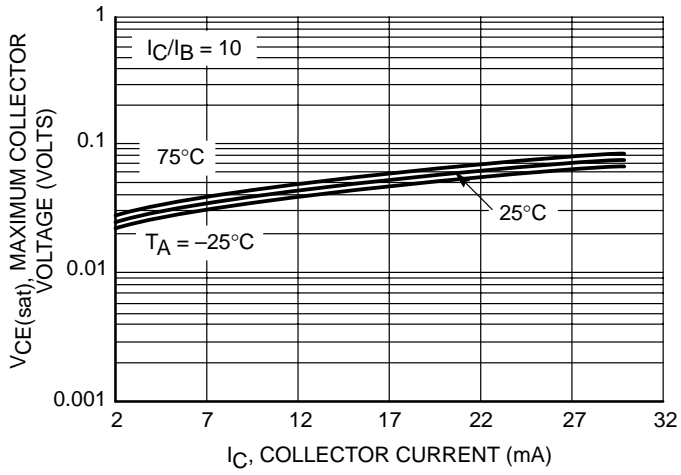

Figure 27.  $V_{CE(sat)}$  vs.  $I_C$

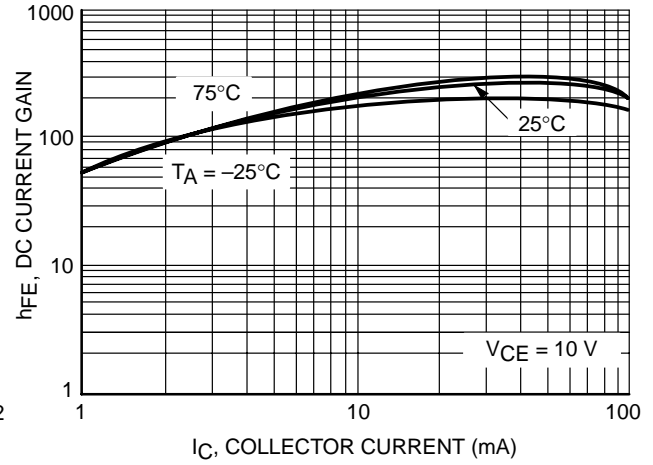

Figure 28. DC Current Gain

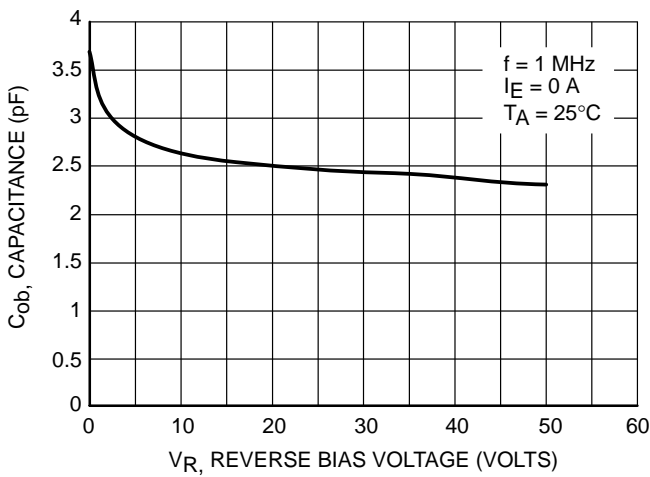

Figure 29. Output Capacitance

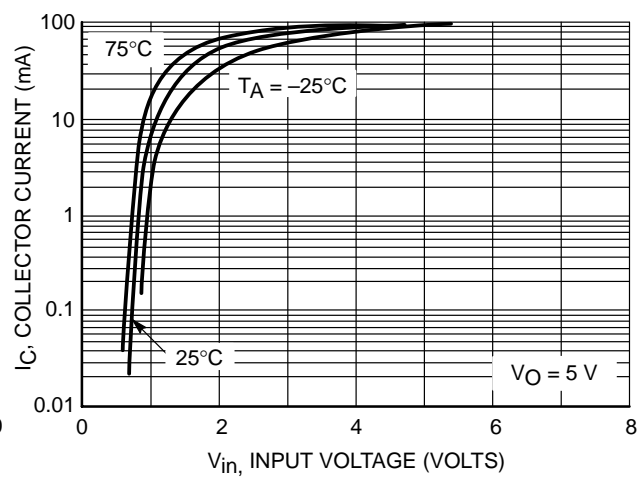

Figure 30. Output Current vs. Input Voltage

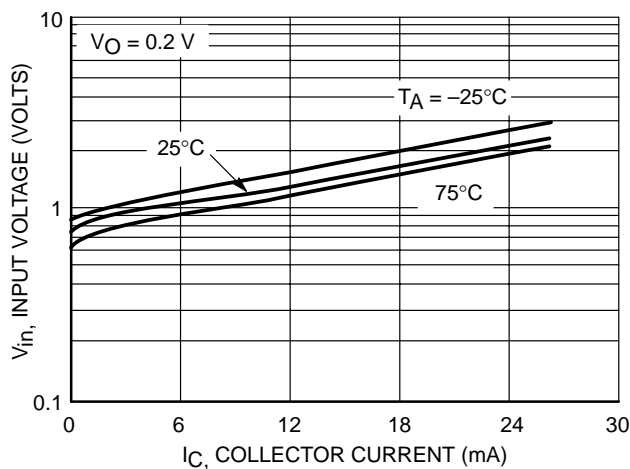

Figure 31. Input Voltage vs. Output Current

TYPICAL APPLICATIONS FOR NPN BRTs

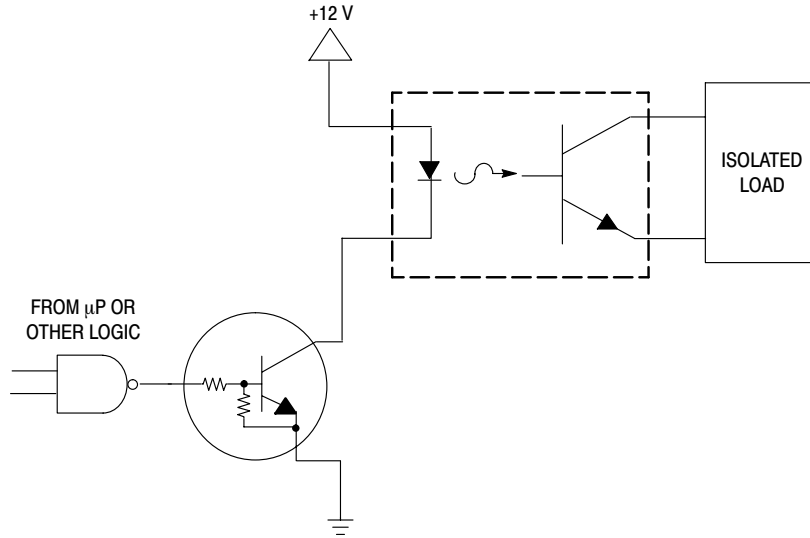

Figure 22. Level Shifter: Connects 12 or 24 Volt Circuits to Logic

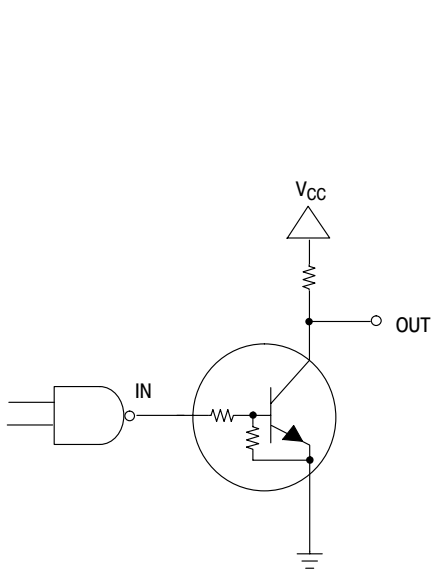

Figure 23. Open Collector Inverter: Inverts the Input Signal

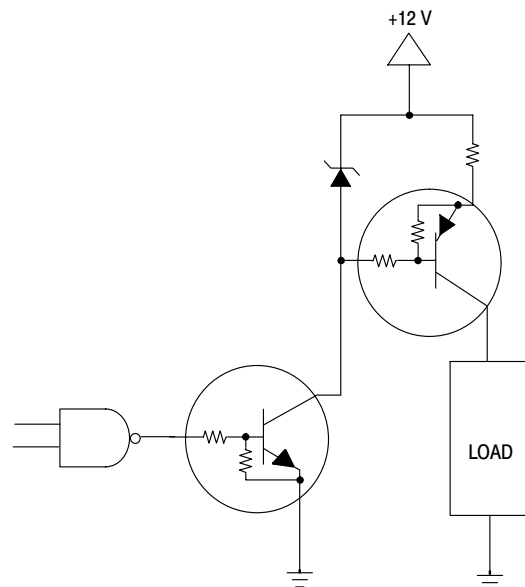
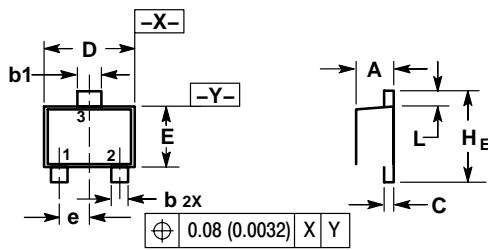

Figure 24. Inexpensive, Unregulated Current Source

## S-LDTC114EM3T5G ;S-S-LDTC114EM3T5G Series

### PACKAGE DIMENSIONS

SOT-723



NOTES:

1. DIMENSIONING AND TOLERANCING PER ANSI Y14.5M, 1982.
2. CONTROLLING DIMENSION: MILLIMETERS.
3. MAXIMUM LEAD THICKNESS INCLUDES LEAD FINISH. MINIMUM LEAD THICKNESS IS THE MINIMUM THICKNESS OF BASE MATERIAL.
4. DIMENSIONS D AND E DO NOT INCLUDE MOLD FLASH, PROTRUSIONS OR GATE BURRS.

DIM	MILLIMETERS			INCHES		
	MIN	NOM	MAX	MIN	NOM	MAX
A	0.45	0.50	0.55	0.018	0.020	0.022
b	0.15	0.20	0.27	0.0059	0.0079	0.0106
b1	0.25	0.3	0.35	0.010	0.012	0.014
C	0.07	0.12	0.17	0.0028	0.0047	0.0067
D	1.15	1.20	1.25	0.045	0.047	0.049
E	0.75	0.80	0.85	0.03	0.032	0.034
e	0.40 BSC			0.016 BSC		
H E	1.15	1.20	1.25	0.045	0.047	0.049
L	0.15	0.20	0.25	0.0059	0.0079	0.0098

- PIN 1. BASE  
2. EMITTER  
3. COLLECTOR

### SOLDERING FOOTPRINT

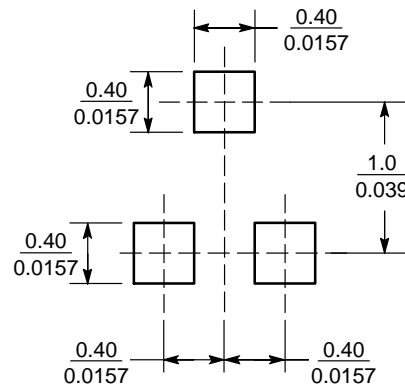

( mm )  
( inches )

## Tape & Reel and Packaging Specifications for Small-Signal Transistors, FETs and Diodes

Embossed Tape and Reel is used to facilitate automatic pick and place equipment feed requirements. The tape is used as the shipping container for various products and requires a minimum of handling. The antistatic/conductive tape provides a secure cavity for the product when sealed with the “peel-back” cover tape.

- Two Reel Sizes Available (7"and 13",)
- Used for Automatic Pick and Place Feed Systems
- Minimizes Product Handling
- EIA 481, -1, -2
- SOT-23, SC-70/SOT-323, SC-89, SC-88/SOT-363, SC-88A/SOT-353, SOD-323, SOD-523 in 8 mm Tape

Use the standard device title and add the required suffix as listed in the option table below (Table 1). Note that the individual reels have a finite number of devices depending on the type of product contained in the tape. Also note the minimum lot size is one full reel for each line item, and orders are required to be in increments of the single reel quantity.

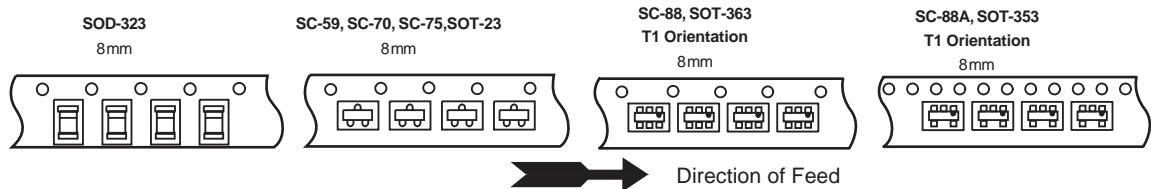

Typical Reel Orientations

Table 1. EMBOSSED TAPE AND REEL ORDERING INFORMATION

Package	Tape Width (mm)	Pitch mm	Reel Size mm(inch)	Devices Per Reel and Minimum Order Quantity	Device Suffix
SOT-23	8	4	178	(7)	3,000 T1
	8		330	(13)	10,000 T3
SC-70/SOT-323	8	4	178	(7)	3,000 T1
	8		330	(13)	10,000 T3
SC-89	8	4	178	(7)	3,000 T1
	8		330	(13)	10,000 T3
SC-88/SOT-363	8	4	178	(7)	3,000 T1
	8		330	(13)	10,000 T3
SC-88A/SOT-353	8	4	178	(7)	3,000 T1
	8		330	(13)	10,000 T3
SOD-323	8	4	178	(7)	3,000 T1
	8		330	(13)	10,000 T3
SOD-523	8	4	178	(7)	3,000 T1
	8		330	(13)	10,000 T3

## EMBOSSED TAPE AND REEL DATA FOR DISCRETES CARRIER TAPE SPECIFICATIONS

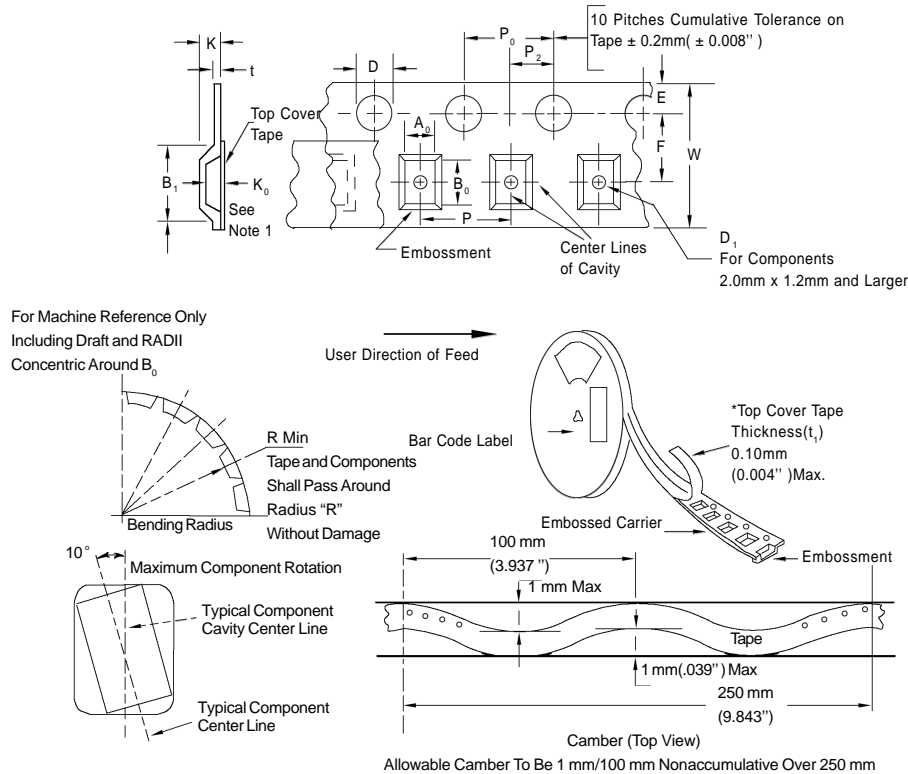

### DIMENSIONS

Tape Size	$B_1$ Max	D	$D_1$	E	F	K	$P_0$	$P_2$	RMin	TMax	WMax
8mm	4.55mm (.179")	1.5+0.1mm -0.0	1.0Min (.039")	1.75±0.1mm (.069±.004)	3.5±0.05mm (.138±.002")	2.4mmMax (.094")	4.0±0.1mm (.157±.004")	2.0±0.1mm (.079±.002")	25mm (.98")	0.6mm (.024")	8.3mm (.327")
12mm	8.2mm (.323")	(.059+.004" -0.0)	1.5mmMin (.060")		5.5±0.05mm (.217±.002")	6.4mmMax (.252")			30mm (1.18")		12±.30mm (.470±.012")
16mm	12.1mm (.476")				7.5±0.10mm (.295±.004")	7.9mmMax (.311")					16.3mm (.642")
24mm	20.1mm (.791")				11.5±0.1mm (.453±.004")	11.9mmMax (.468")					24.3mm (.957")

Metric dimensions govern - English are in parentheses for reference only.

NOTE 1:  $A_0$ ,  $B_0$ , and  $K_0$  are determined by component size. The clearance between the components and the cavity must be within .05 mm min. to .50 mm max.,

NOTE 2: the component cannot rotate more than 10° within the determined cavity.

NOTE 3: If  $B_1$  exceeds 4.2 mm (.165") for 8 mm embossed tape, the tape may not feed through all tape feeders.

## EMBOSSED TAPE AND REEL DATA FOR DISCRETES

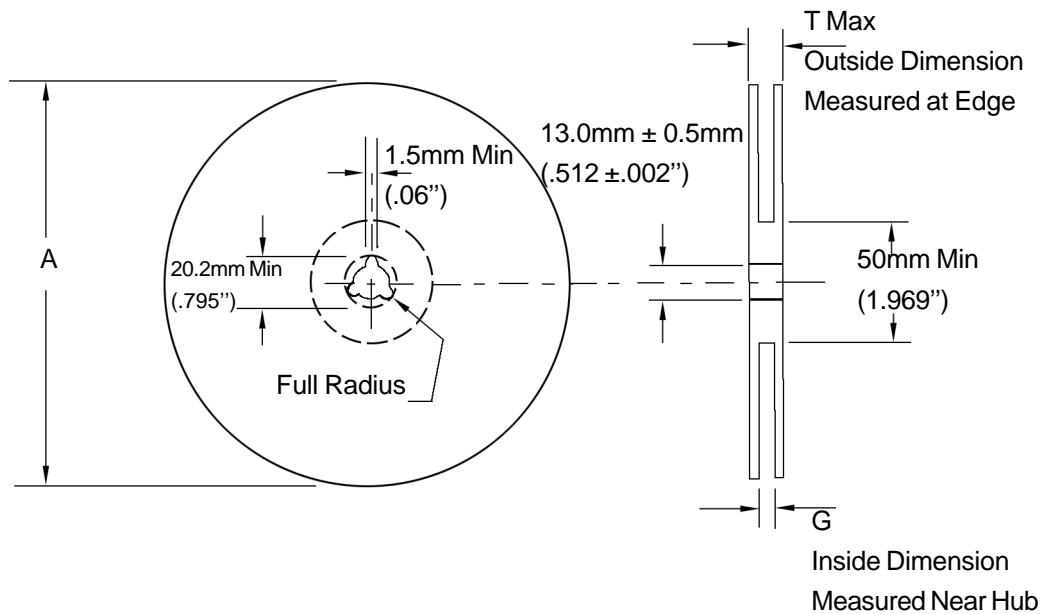

Size	A Max	G	T Max
8 mm	330mm (12.992")	8.4mm+1.5mm, -0.0 (.33"+.059", -0.00)	14.4mm (.56")
12mm	330mm (12.992")	12.4mm+2.0mm, -0.0 (.49 "+ .079", -0.00)	18.4mm (.72")
16mm	360mm (14.173")	16.4mm+2.0mm, -0.0 (.646"+.078", -0.00)	22.4mm (.882")
24 mm	360mm (14.173")	24.4mm+2.0mm, -0.0 (.961"+.070", -0.00)	30.4mm (1.197")

### Reel Dimensions

Metric Dimensions Govern — English are in parentheses for reference only

#### Storage Conditions

Temperature: 5 to 40 Deg.C (20 to 30 Deg. C is preferred)

Humidity: 30 to 80 RH (40 to 60 is preferred )

Recommended Period: One year after manufacturing

(This recommended period is for the soldering condition only. The characteristics and reliabilities of the products are not restricted to this limitation)

## X-ON Electronics

Largest Supplier of Electrical and Electronic Components

*Click to view similar products for [Bipolar Transistors - Pre-Biased](#) category:*

*Click to view products by [Leshan](#) manufacturer:*

Other Similar products are found below :

[DRC9A14E0L](#) [DTA124GKAT146](#) [DTA144WETL](#) [DTA144WKAT146](#) [DTC113EET1G](#) [DTC115TETL](#) [DTC115TKAT146](#)  
[DTC144VUAT106](#) [MUN5241T1G](#) [BCR158WH6327XTSA1](#) [NSBA114TDP6T5G](#) [SMUN5330DW1T1G](#) [SSVMUN5312DW1T2G](#)  
[RN1303\(TE85L,F\)](#) [RN1306\(TE85L,F\)](#) [EMH15T2R](#) [SMUN2214T3G](#) [SMUN5335DW1T1G](#) [NSBC143ZPDP6T5G](#) [NSVDTA143ZET1G](#)  
[SMUN2214T1G](#) [FMA7AT148](#) [DTC114EUA-TP](#) [SMUN5237DW1T1G](#) [SMUN5213DW1T1G](#) [SMUN5114DW1T1G](#) [SMUN2111T1G](#)  
[DTC124ECA-TP](#) [DTA114ECA-TP](#) [DTC113EM3T5G](#) [NSVMUN5135DW1T1G](#) [NSVMUN2237T1G](#) [NSVDTC143ZM3T5G](#)  
[SMUN5335DW1T2G](#) [SMUN5216DW1T1G](#) [NSVMUN5316DW1T1G](#) [NSVMUN5215DW1T1G](#) [NSVMUN5213DW1T3G](#)  
[NSVMUN2112T1G](#) [NSVIMD10AMT1G](#) [NSVEMC2DXV5T1G](#) [NSVDTC144WET1G](#) [NSVDTC123JET1G](#) [NSVDTA143EM3T5G](#)  
[NSVB1706DMW5T1G](#) [NSBC143EDP6T5G](#) [RN2101,LF\(CT](#) [NSBA144WDXV6T1G](#) [DTA115TET1G](#) [NSBC115TDP6T5G](#)