

LESD9D12T5G ESD PROTECTION DIODE

Discription

The LESD9D12T5G is designed to protect voltage sensitive components from ESD. Excellent clamping capability, low leakage, and fast response time provide best in class protection on designs that are exposed to ESD. Because of its small size, it is suited for use in cellular phones, MP3 players, digital cameras and many other portable applications where board space is at a premium.

Applications

- | Cellular phones audio
- | MP3 players
- | Digital cameras
- | Portable applications
- | mobile telephone

Features

- | Small Body Outline Dimensions:
0.039" x 0.024"(1.0 mm x 0.60 mm)
- | Low Body Height: 0.017" (0.43 mm) Max
- | Stand-off Voltage: 3.3 V – 12 V
- | Low Leakage
- | Response Time is Typically < 1 ns
- | ESD Rating of Class 3 (> 16 kV) per Human Body Model
- | IEC61000-4-2 Level 4 ESD Protection
- | We declare that the material of product compliance with RoHS requirements.
- | S- Prefix for Automotive and Other Applications Requiring Unique Site and Control Change Requirements; AEC-Q101 Qualified and PPAP Capable.

LESD9D12T5G
S-LESD9D12T5G

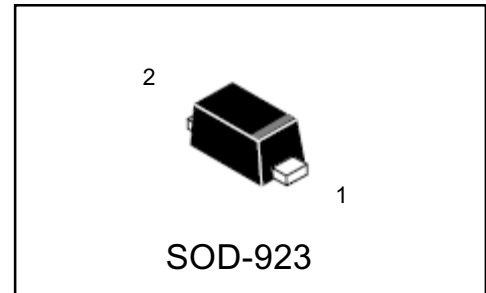

PIN 1. CATHODE
2. ANODE

Ordering information

Device	Marking	Shipping
LESD9D12T5G S-LESD9D12T5G	H	8000/Tape&Reel

MAXIMUM RATINGS

Rating	Symbol	Value	Unit
IEC 61000-4-2 (ESD) Air Contact Contact discharge		±15 ±8	kV kV
ESD Voltage Per Human Body Model		16	kV
Total Power Dissipation on FR-5 Board (Note 1) @ T _A =25°C	PD	150	Mw
Junction and Storage Temperature Range	T _J ,T _{STG}	-55 to 150	°C
Lead Solder Temperature – Maximum (10 Second Duration)	TL	260	°C

Stresses exceeding Maximum Ratings may damage the device. Maximum Rating are stress ratings only. Functional operation above the Recommended Operating Conditions is not implied. Extended exposure to stresses above the Recommended Operating Conditions may affect device reliability.

1. FR-5 = 1.0*0.75*0.62 in.

LESD9D12T5G , S-LESD9D12T5G

ELECTRICAL CHARACTERISTICS

($T_A = 25^\circ\text{C}$ unless otherwise noted)

Symbol	Parameter
I_{PP}	Maximum Reverse Peak Pulse Current
V_C	Clamping Voltage @ I_{PP}
V_{RWM}	Working Peak Reverse Voltage
I_R	Maximum Reverse Leakage Current @ V_{RWM}
V_{BR}	Breakdown Voltage @ I_T
I_T	Test Current
I_F	Forward Current
V_F	Forward Voltage @ I_F
P_{pk}	Peak Power Dissipation
C	Max. Capacitance @ $V_R = 0$ and $f = 1$ MHz

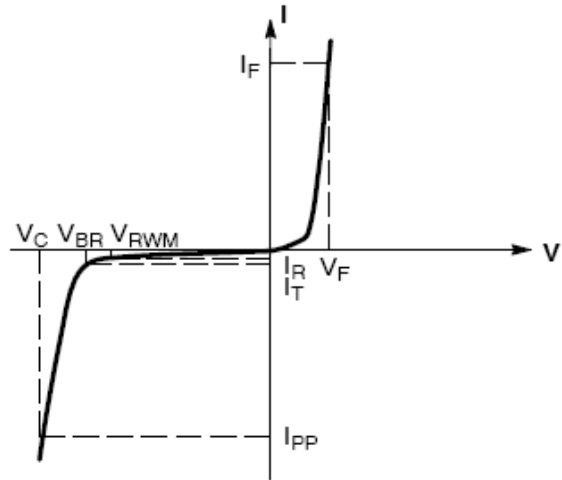

Uni-Directional TVS

ELECTRICAL CHARACTERISTICS ($T_A=25^\circ\text{C}$ unless otherwise noted, $V_F=0.9\text{V}$ Max. @ $I_F=10\text{Ma}$ for all types)

Device	V_{RWM} (V)	I_R (μA) @ V_{RWM}	V_{BR} (V) @ I_T (Note 2)	I_T (mA)	I_{PP} (A) (Note 3)	V_C (V) @ Max I_{PP} (Note 3)	P_{PK} (W) (8*20 μs)	C (pF)
	Max	Max	Min		Max	Max	Typ	Typ
LESD9D3.3T5G	3.3	2.5	5.0	1.0	9.8	10.4	102	80
LESD9D5.0T5G	5.0	1.0	6.2	1.0	8.7	12.3	107	65
LESD9D12T5G	12	1.0	13.5	1.0	5.9	23.7	140	30

Other voltage available upon request.

- V_{BR} is measured with a pulse test current I_T at an ambient temperature of 25°C
- Surge current waveform per Figure 3.

LESD9D12T5G , S-LESD9D12T5G

TYPICAL CHARACTERISTICS

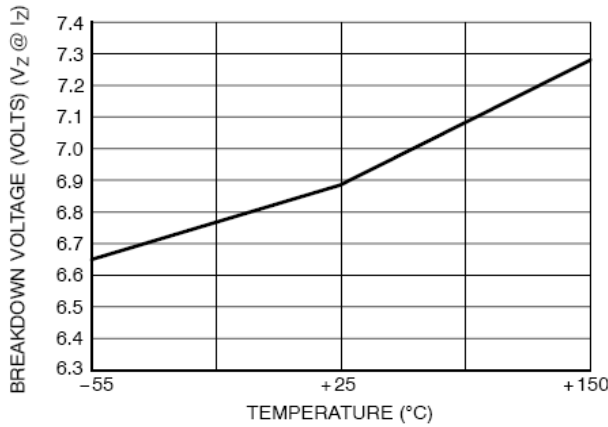

Figure 1. Typical Breakdown Voltage versus Temperature

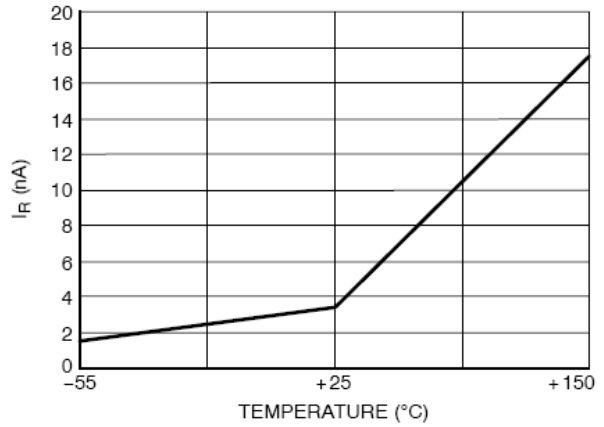

Fig 2. Typical Leakage Current versus Temperature

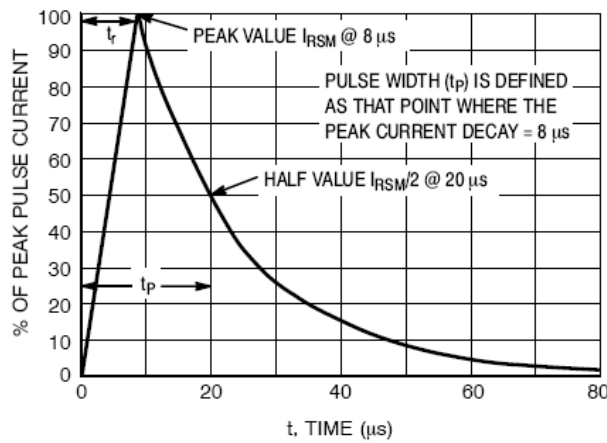

Figure 3. 8*20 μs Pulse Waveform

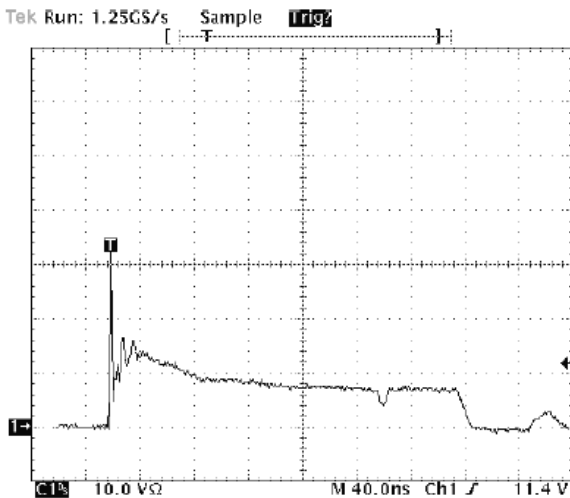

Figure 4. Positive 8kV contact per IEC 61000-4-2-LESD9D5.0T5G

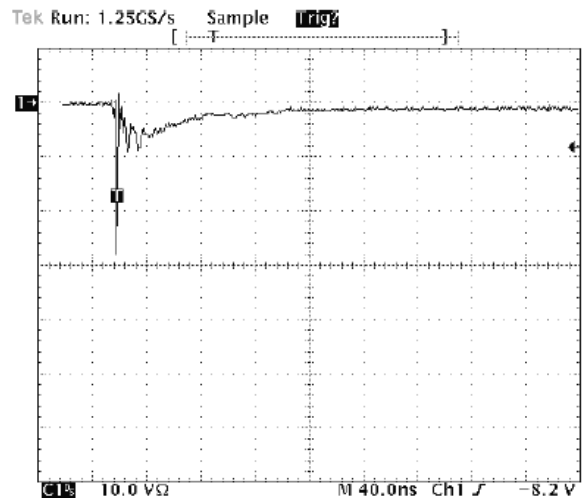
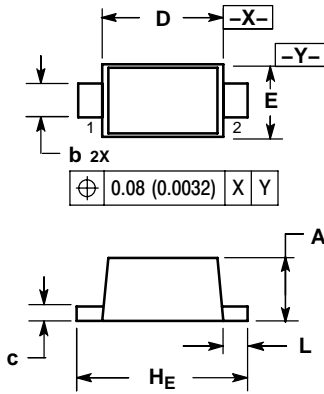

Fig 5. Negative 8kV contact per IEC 61000-4-2-LESD9D5.0T5G

LESD9D12T5G , S-LESD9D12T5G

SOD-923



- NOTES:
1. DIMENSIONING AND TOLERANCING PER ANSI Y14.5M, 1982.
 2. CONTROLLING DIMENSION: MILLIMETERS.
 3. MAXIMUM LEAD THICKNESS INCLUDES LEAD FINISH THICKNESS. MINIMUM LEAD THICKNESS IS THE MINIMUM THICKNESS OF BASE MATERIAL.

DIM	MILLIMETERS			INCHES		
	MIN	NOM	MAX	MIN	NOM	MAX
A	0.34	0.37	0.40	0.013	0.015	0.016
b	0.15	0.20	0.25	0.006	0.008	0.010
c	0.07	0.12	0.17	0.003	0.005	0.007
D	0.75	0.80	0.85	0.030	0.031	0.033
E	0.55	0.60	0.65	0.022	0.024	0.026
HE	0.95	1.00	1.05	0.037	0.039	0.041
L	0.05	0.10	0.15	0.002	0.004	0.006

SOLDERING FOOTPRINT*

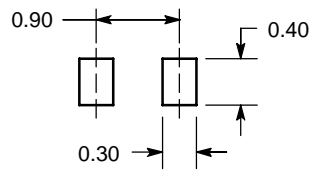

DIMENSIONS: MILLIMETERS

EMBOSSED TAPE AND REEL DATA FOR DISCRETES CARRIER TAPE SPECIFICATIONS

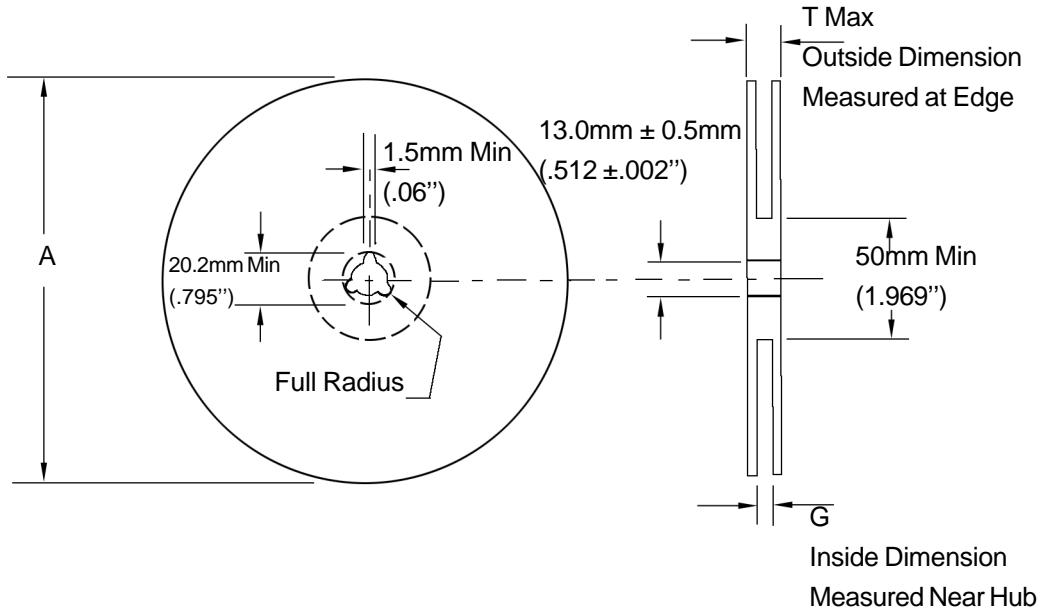

Size	A Max	G	T Max
8 mm	178.0mm (7.0")	8.4mm+1.5mm, -0.0 (.33"+.039", -0.00)	10.9mm (.43")

Reel Dimensions

Metric Dimensions Govern — English are in parentheses for reference only

Storage Conditions

Temperature: 5 to 40 Deg.C (20 to 30 Deg. C is preferred)

Humidity: 30 to 80 RH (40 to 60 is preferred)

Recommended Period: One year after manufacturing

(This recommended period is for the soldering condition only. The characteristics and reliabilities of the products are not restricted to this limitation)

Tape peeling strength: 10 to 100 (g).

Shipment Specification

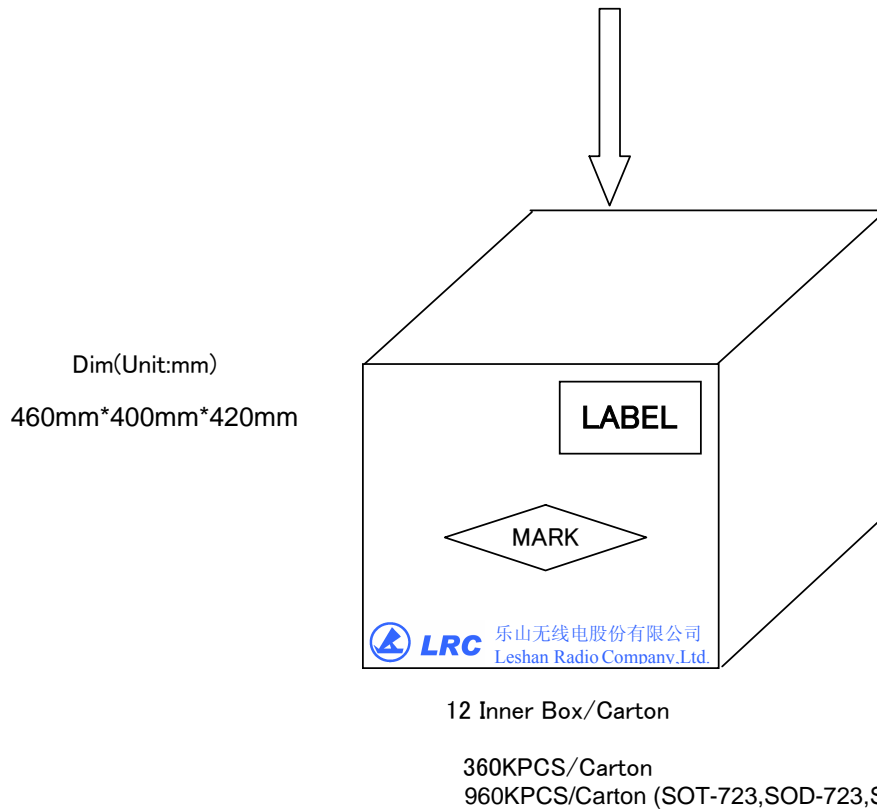
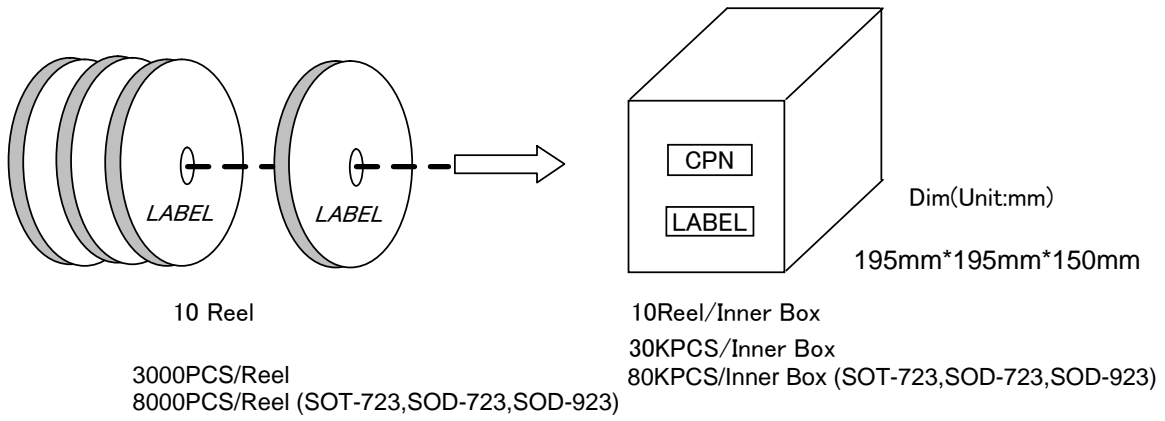

X-ON Electronics

Largest Supplier of Electrical and Electronic Components

Click to view similar products for [ESD Suppressors / TVS Diodes](#) category:

Click to view products by [Leshan](#) manufacturer:

Other Similar products are found below :

[60KS200C](#) [D18V0L1B2LP-7B](#) [D5V0F4U5P5-7](#) [DESD5V0U1BB-7](#) [NTE4902](#) [P4KE27CA](#) [P6KE11CA](#) [P6KE39CA-TP](#) [P6KE8.2A](#)
[SA110CA](#) [SA60CA](#) [SA64CA](#) [SMBJ12CATR](#) [SMBJ33CATR](#) [SMBJ8.0A](#) [ESD101-B1-02ELS E6327](#) [ESD105-B1-02EL E6327](#) [ESD112-B1-02EL E6327](#) [ESD119B1W01005E6327XTSA1](#) [ESD5V0L1B02VH6327XTSA1](#) [ESD7451N2T5G](#) [19180-510](#) [CPDT-5V0USP-HF](#)
[3.0SMCJ33CA-F](#) [3.0SMCJ36A-F](#) [HSPC16701B02TP](#) [D3V3Q1B2DLP3-7](#) [D55V0M1B2WS-7](#) [DESD5V0U1BL-7B](#) [DRTR5V0U4SL-7](#)
[SCM1293A-04SO](#) [ESD200-B1-CSP0201 E6327](#) [SM12-7](#) [SMF8.0A-TP](#) [SMLJ45CA-TP](#) [CEN955 W/DATA](#) [82350120560](#) [VESD12A1A-](#)
[HD1-GS08](#) [CPDUR5V0R-HF](#) [CPDQC5V0U-HF](#) [CPDQC5V0USP-HF](#) [CPDQC5V0-HF](#) [D1213A-01LP4-7B](#) [D1213A-02WL-7](#)
[MMAD1108/TR13](#) [5KP100A](#) [5KP15A](#) [5KP18A](#) [5KP48A](#) [5KP90A](#)