

LMBR01S30ST5G

S-LMBR01S30ST5G

Schottky Barrier Diode

1. FEATURES

- We declare that the material of product compliance with RoHS requirements and Halogen Free.
- S- prefix for automotive and other applications requiring unique site and control change requirements; AEC-Q101 qualified and PPAP capable.
- Extremely small surface mounting type.(DFN0603)
- Low IR.
- High reliability.

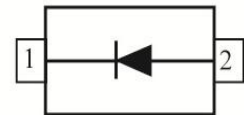
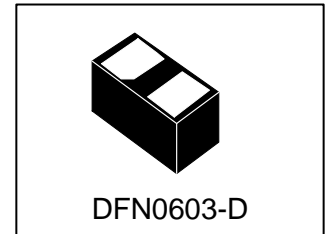

2. APPLICATIONS

- Low current rectification

3. DEVICE MARKING AND ORDERING INFORMATION

Device	Marking	Shipping
LMBR01S30ST5G	S	15000/Tape&Reel

4. MAXIMUM RATINGS(Ta = 25°C)

Parameter	Symbol	Limits	Unit
DC Reverse Voltage	VR	30	V
Mean Rectifying Current	IO	100	mA
Peak Forward Surge Current	IFSM	2	A

5. THERMAL CHARACTERISTICS

Parameter	Symbol	Limits	Unit
Total Device Dissipation, FR-5 Board (Note 1) @ TA = 25°C Derate above 25°C	PD	200 1.58	mW mW/°C
Thermal Resistance, Junction-to-Ambient(Note 1)	RθJA	635	°C/W
Junction Temperature	TJ	100	°C
Storage Temperature Range	Tstg	-40 ~ +100	°C
Operating Temperature Range	Top	-40 ~ +100	°C

1. FR-5 = 1.0×0.75×0.062 in.

6. ELECTRICAL CHARACTERISTICS (Ta= 25°C)

Characteristic	Symbol	Min.	Typ.	Max.	Unit
Reverse Voltage Leakage Current (VR = 10Vdc)	IR	-	-	10	μA
(VR = 30Vdc)		-	-	20	
Diode Capacitance (VR = 0V , f = 1.0 MHz)	CT	-	8.2	-	pF
Forward Voltage (IF = 60 mAdc)	VF	-	-	0.37	V
(IF = 10 mAdc)		-	-	0.3	

7. ELECTRICAL CHARACTERISTICS CURVES

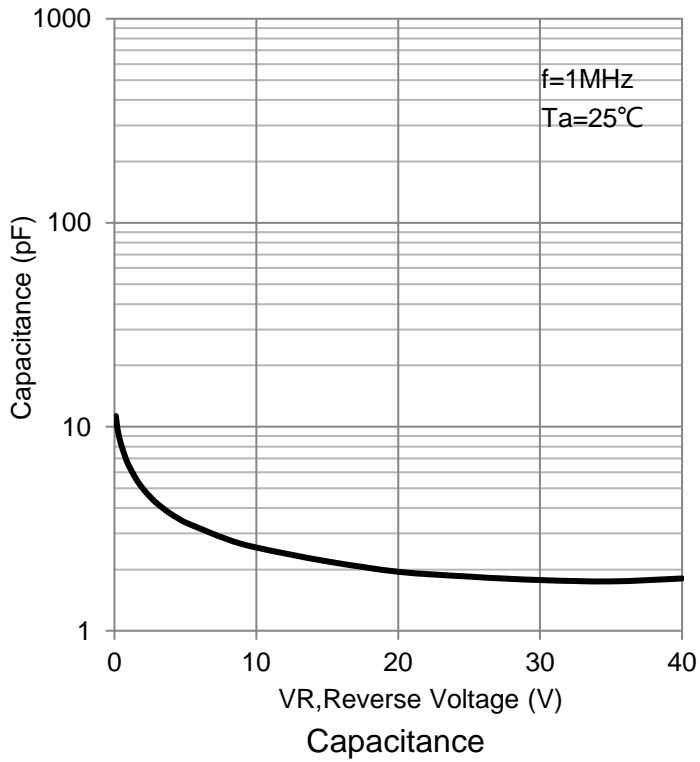
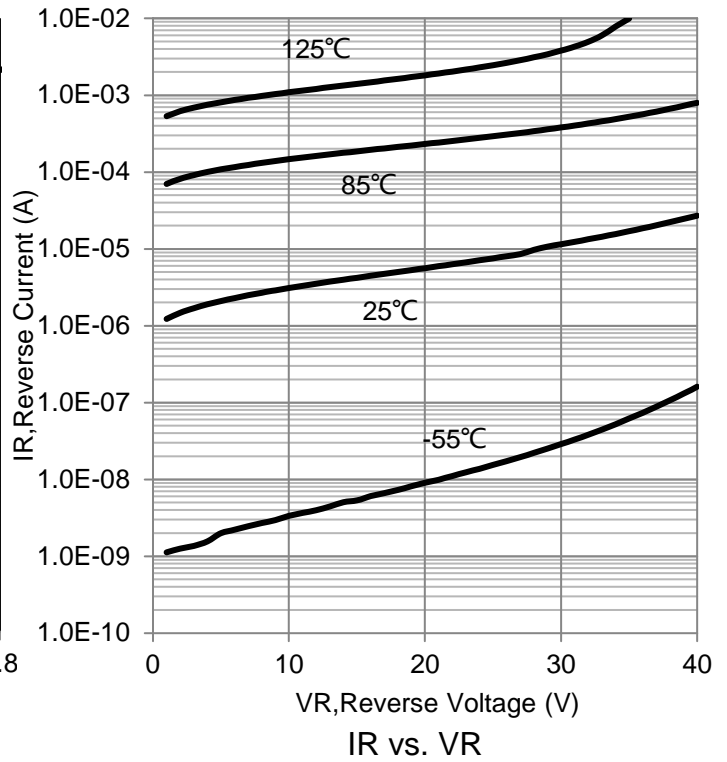
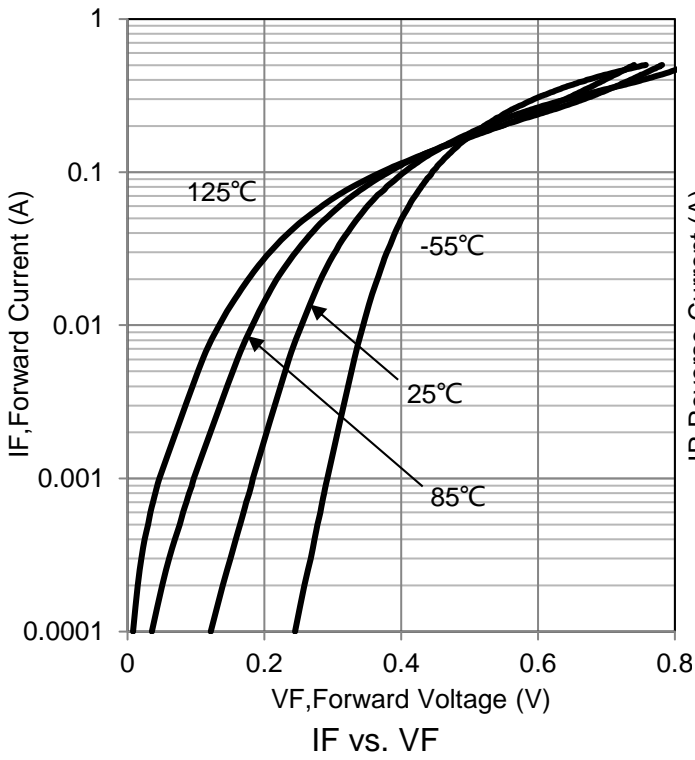

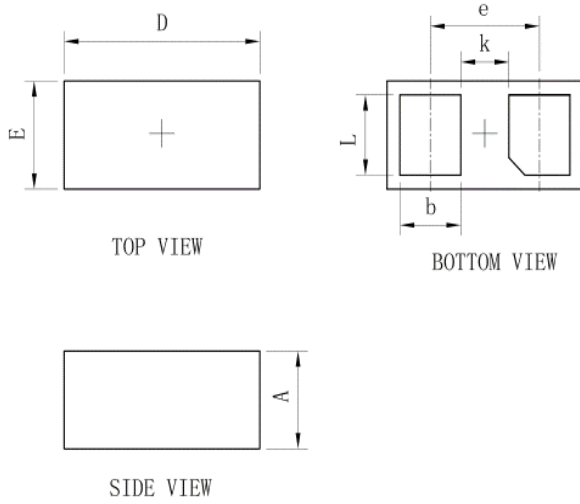
8. OUTLINE AND DIMENSIONS

DFN0603-DL			
Dim	Min	Typ.	Max
D	0.58	0.61	0.64
E	0.28	0.31	0.34
e	-	0.34	-
L	0.20	0.23	0.26
b	0.16	0.19	0.22
A	0.25	0.28	0.31
k	0.12	0.15	0.18
All Dimensions in mm			

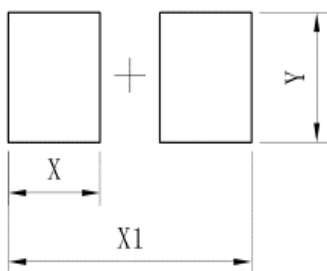
9. SOLDERING FOOTPRINT

DFN0603-DL	
DIM	(mm)
X	0.23
X1	0.61
Y	0.30

X-ON Electronics

Largest Supplier of Electrical and Electronic Components

Click to view similar products for [Schottky Diodes & Rectifiers](#) category:

Click to view products by [Leshan](#) manufacturer:

Other Similar products are found below :

[CUS06\(TE85L,Q,M\)](#) [MA4E2039](#) [D1FH3-5063](#) [MBR0530L-TP](#) [MBR10100CT-BP](#) [MBR30H100MFST1G](#) [MMBD301M3T5G](#) [PMAD1103-LF](#) [PMAD1108-LF](#) [RB160M-50TR](#) [RB520S-30](#) [RB551V-30](#) [DD350N18K](#) [DZ435N40K](#) [DZ600N16K](#) [BAS16E6433HTMA1](#) [BAS 3010S-02LRH E6327](#) [BAT 54-02LRH E6327](#) [IDL02G65C5XUMA1](#) [NSR05F40QNXT5G](#) [NSVR05F40NXT5G](#) [JANS1N6640](#) [SB07-03C-TB-H](#) [SB1003M3-TL-W](#) [SBAT54CWT1G](#) [SBM30-03-TR-E](#) [SBS818-TL-E](#) [SK32A-LTP](#) [SK33A-TP](#) [SK34A-TP](#) [SK34B-TP](#) [SMD1200PL-TP](#) [ACDBN160-HF](#) [SS3003CH-TL-E](#) [STPS30S45CW](#) [PDS3100Q-7](#) [GA01SHT18](#) [CRS10I30A\(TE85L,QM\)](#) [MBR1240MFST1G](#) [MBRB30H30CT-1G](#) [BAS28E6433HTMA1](#) [BAS 70-02L E6327](#) [HSB123JTR-E](#) [JANTX1N5712-1](#) [VS-STPS40L45CW-N3](#) [DD350N12K](#) [SB007-03C-TB-E](#) [SB10015M-TL-E](#) [SB1003M3-TL-E](#) [SK110-LTP](#)