

LMBR1150FT1G

Schottky Barrier Diode

1. FEATURES

- Low power losses, high efficiency.
- Guardring for over voltage protection.
- For use in low voltage high frequency inverters, free wheeling, and polarity protection applications
- We declare that the material of product compliance with RoHS requirements and Halogen Free.

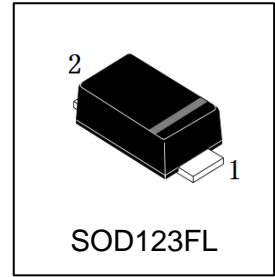

2. DEVICE MARKING AND ORDERING INFORMATION

Device	Marking	Shipping
LMBR1150FT1G	115	3000/Tape&Reel

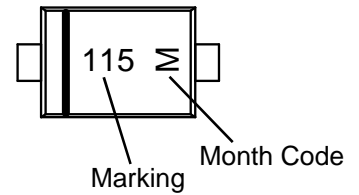

3. MAXIMUM RATINGS(Ta = 25°C)

Parameter	Symbol	Limits	Unit
Maximum repetitive peak reverse voltage	VRRM	150	V
Maximum RMS voltage	VRMS	105	V
Maximum DC blocking voltage	VDC	150	V
Maximum average forward rectified current at TC = 75°C	IF(AV)	1	A
Peak forward surge current 8.3ms single half sine-wave superimposed on rated load (JEDEC Method)	IFSM	30	A
Power Dissipation	PD	400	mW
Typical thermal resistance (Note 1)	RθJA	170	°C/W
	RθJL	40	
Operating junction temperature range	TJ	-40 ~ +150	°C
storage temperature range	TSTG	-40 ~ +150	°C

4. ELECTRICAL CHARACTERISTICS (Ta= 25°C)

Characteristic	Symbol	Min	Typ.	Max	Unit
Maximum instantaneous forward (IF = 0.7 A, TJ = 25°C)	VF	-	-	0.9	V
Maximum DC reverse current at rated DC blocking voltage TA = 25°C Tj = 125°C	IR	-	-	5	uA
		-	-	10	mA
Junction capacitance at 4.0V, 1MHz	CJ	-	23	-	pF

Note: 1. 8.0mm² (.013mm thick) land areas

5. ELECTRICAL CHARACTERISTICS CURVES

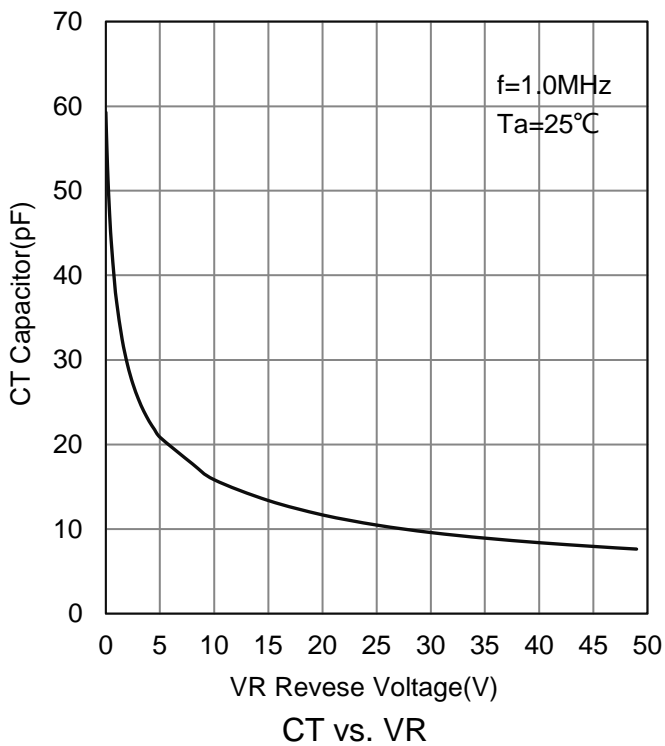
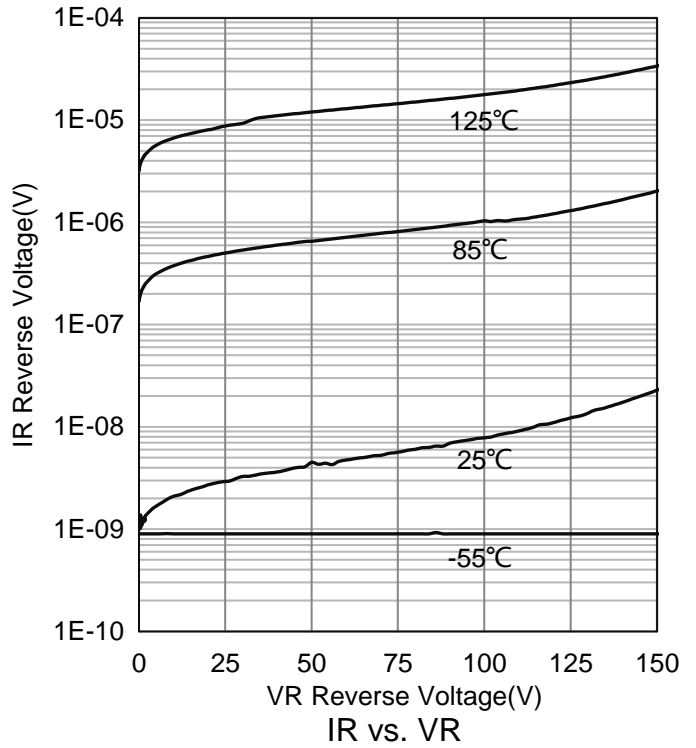
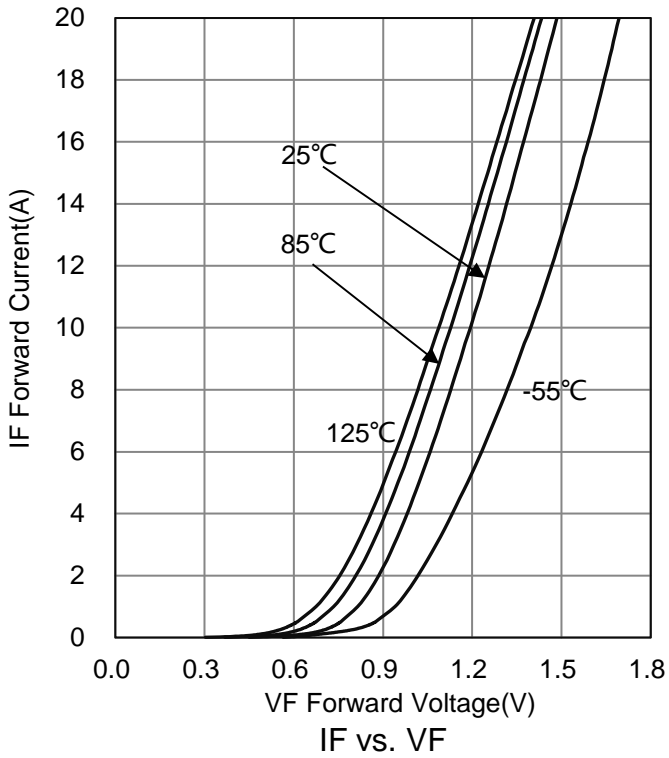

6. OUTLINE AND DIMENSIONS

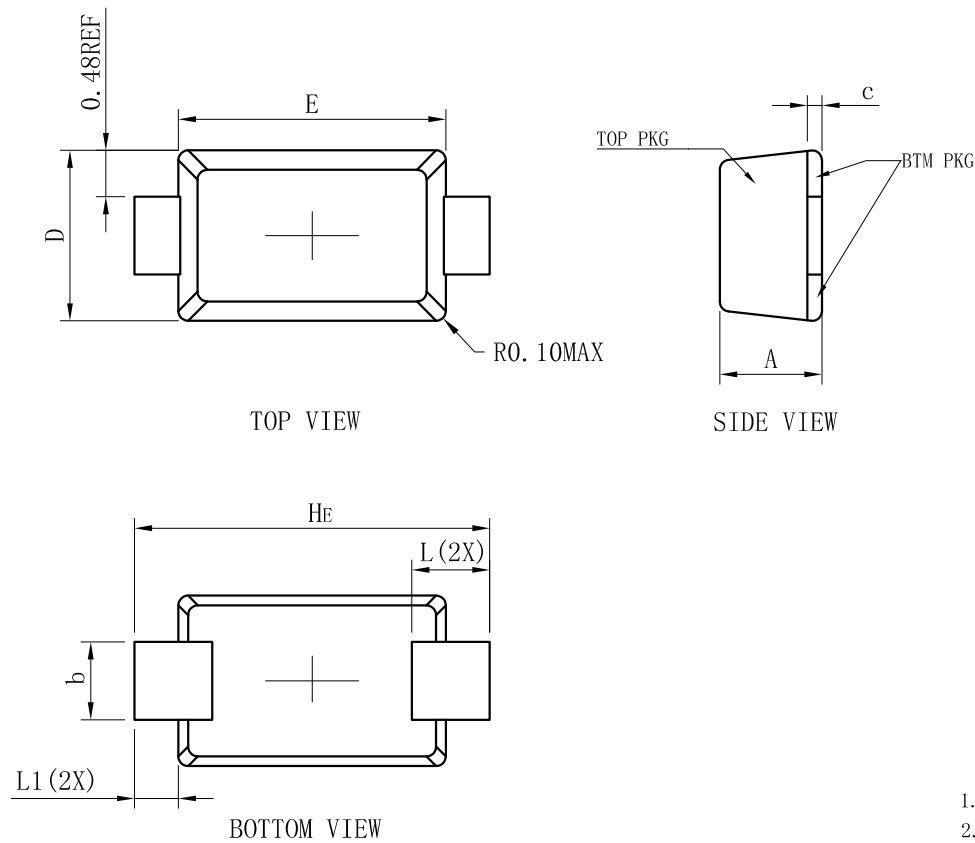

7. SOLDERING FOOTPRINT

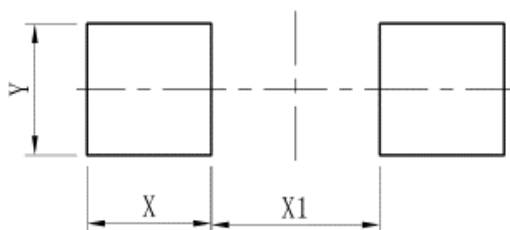

DIM	(mm)
X	1.20
Y	1.10
X1	2.00

DISCLAIMER

- Before you use our Products, you are requested to carefully read this document and fully understand its contents. LRC shall not be in any way responsible or liable for failure, malfunction or accident arising from the use of any LRC's Products against warning, caution or note contained in this document.
- All information contained in this document is current as of the issuing date and subject to change without any prior notice. Before purchasing or using LRC's Products, please confirm the latest information with a LRC sales representative.

X-ON Electronics

Largest Supplier of Electrical and Electronic Components

Click to view similar products for [Schottky Diodes & Rectifiers](#) category:

Click to view products by [Leshan](#) manufacturer:

Other Similar products are found below :

[MA4E2039](#) [MA4E2508M-1112](#) [MBR1545CT](#) [MMBD301M3T5G](#) [RB160M-50TR](#) [D83C](#) [BAS16E6433HTMA1](#) [BAT 54-02LRH E6327](#)
[NRVBAF360T3G](#) [NSR05F40QNXT5G](#) [NTE555](#) [JANS1N6640](#) [SK310-T](#) [SK34B-TP](#) [SS3003CH-TL-E](#) [GA01SHT18](#)
[CRS10I30A\(TE85L,QM](#) [MA4E2501L-1290](#) [MBRA140TRPBF](#) [MBRB30H30CT-1G](#) [BAT 15-04R E6152](#) [JANTX1N5712-1](#) [DMJ3940-000](#)
[SB007-03C-TB-E](#) [SK33B-TP](#) [NRVBB20100CTT4G](#) [NRVBM120LT1G](#) [NTSB30U100CT-1G](#) [VS-6CWQ10FNHM3](#) [CRG04\(T5L,TEMQ\)](#)
[ACDBA1100LR-HF](#) [ACDBA1200-HF](#) [ACDBA240-HF](#) [ACDBA3100-HF](#) [CDBQC0530L-HF](#) [CDBQC0240LR-HF](#) [ACDBA260LR-HF](#)
[ACDBA1100-HF](#) [MA4E2502L-1246](#) [10BQ015-M3/5BT](#) [NRVBM120ET1G](#) [CRS08TE85LQM](#) [PMAD1108-LF](#) [B120Q-13-F](#) [1N5819T-G](#)
[B0530WSQ-7-F](#) [PDS1040Q-13](#) [B160BQ-13-F](#) [SDM05U20CSP-7](#) [B140S1F-7](#)