

LMBT3904DW1T1G

S-LMBT3904DW1T1G

General Purpose Transistors NPN Silicon

1. FEATURES

- We declare that the material of product compliance with RoHS requirements and Halogen Free.
- S- prefix for automotive and other applications requiring unique site and control change requirements; AEC-Q101 qualified and PPAP capable.
- Low $V_{CE(sat)}$, ≤ 0.4 V
- Simplifies circuit design
- Reduces board space
- Reduces component count
- Available in 8 mm, 7-inch/3,000 unit tape and reel
- h_{FE} , 100–300

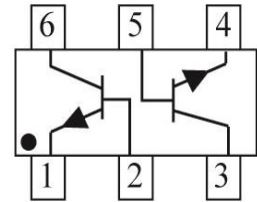
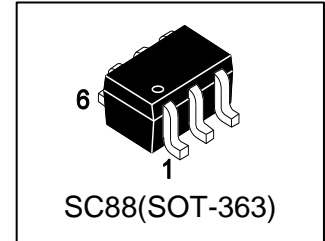

2. DEVICE MARKING AND ORDERING INFORMATION

Device	Marking	Shipping
LMBT3904DW1T1G	MA	3000/Tape&Reel
LMBT3904DW1T3G	MA	10000/Tape&Reel

3. MAXIMUM RATINGS($T_a = 25^\circ\text{C}$)

Parameter	Symbol	Limits	Unit
Collector–Emitter Voltage	V_{CEO}	40	Vdc
Collector–Base Voltage	V_{CBO}	60	Vdc
Emitter–Base Voltage	V_{EBO}	6	Vdc
Collector Current — Continuous	I_C	200	mAdc

4. THERMAL CHARACTERISTICS

Parameter	Symbol	Limits	Unit
Total Device Dissipation, FR-5 Board (Note 1) @ $T_A = 25^\circ\text{C}$ Derate above 25°C	PD	150 1.2	mW mW/ $^\circ\text{C}$
Thermal Resistance, Junction–to–Ambient(Note 1)	$R_{\theta JA}$	833	$^\circ\text{C}/\text{W}$
Junction and Storage temperature	T_J, T_{stg}	$-55 \sim +150$	$^\circ\text{C}$

1. FR-5 = $1.0 \times 0.75 \times 0.062$ in.

5. ELECTRICAL CHARACTERISTICS (Ta= 25°C)
OFF CHARACTERISTICS

Characteristic	Symbol	Min.	Typ.	Max.	Unit
Collector–Emitter Breakdown Voltage (IC = 1.0 mAdc, IB = 0)	VBR(CEO)	40	-	-	V
Collector–Base Breakdown Voltage (IC = 10 µAdc, IE = 0)	VBR(CBO)	60	-	-	V
Emitter–Base Breakdown Voltage (IE = 10 µAdc, IC = 0)	VBR(EBO)	6	-	-	V
Collector Cutoff Current (VCE = 30 Vdc, VEB = 3.0Vdc)	ICEX	-	-	50	nA
Base Cutoff Current (VCE = 30 Vdc, VEB = 3.0Vdc)	IBL	-	-	50	nA

ON CHARACTERISTICS (Note 2.)

DC Current Gain (IC = 0.1 mAdc, VCE = 10 Vdc) (IC = 1.0 mAdc, VCE = 1.0 Vdc) (IC = 10 mAdc, VCE = 1.0 Vdc) (IC = 50 mAdc, VCE = 1.0 Vdc) (IC = 100 mAdc, VCE = 1.0 Vdc)	HFE	40 70 100 60 30	- - - - -	- - 300 - -	
Collector–Emitter Saturation Voltage (IC = 10 mAdc, IB = 1.0 mAdc) (IC = 50 mAdc, IB = 5.0 mAdc)	VCE(sat)	- -	- -	0.2 0.3	V
Base–Emitter Saturation Voltage (IC = 10 mAdc, IB = 1.0 mAdc) (IC = 50 mAdc, IB = 5.0 mAdc)	VBE(sat)	0.65 -	- -	0.85 0.95	V

SMALL–SIGNAL CHARACTERISTICS

Current–Gain — Bandwidth Product (IC = 10mAdc, VCE= 20Vdc, f = 100MHz)	fT	300	-	-	MHz
Output Capacitance (VCB = 5.0 Vdc, IE = 0, f = 1.0 MHz)	Cobo	-	-	4	pF
Input Capacitance (VEB = 0.5 Vdc, IC = 0, f = 1.0 MHz)	Cibo	-	-	8	pF

SWITCHING CHARACTERISTICS

Delay Time	(VCC = 3.0 Vdc, VBE=-0.5Vdc, IC = 10mAdc, IB1 = 1.0 mAdc)	td	-	-	35	ns
Rise Time		tr	-	-	35	
Storage Time	(VCC = 3.0 Vdc, IC = 10 mAdc, IB1 = IB2 = 1.0 mAdc)	ts	-	-	200	
Fall Time		tf	-	-	50	

2.Pulse Test: Pulse Width ≤300 µs, Duty Cycle ≤2.0%.

6. ELECTRICAL CHARACTERISTICS CURVES

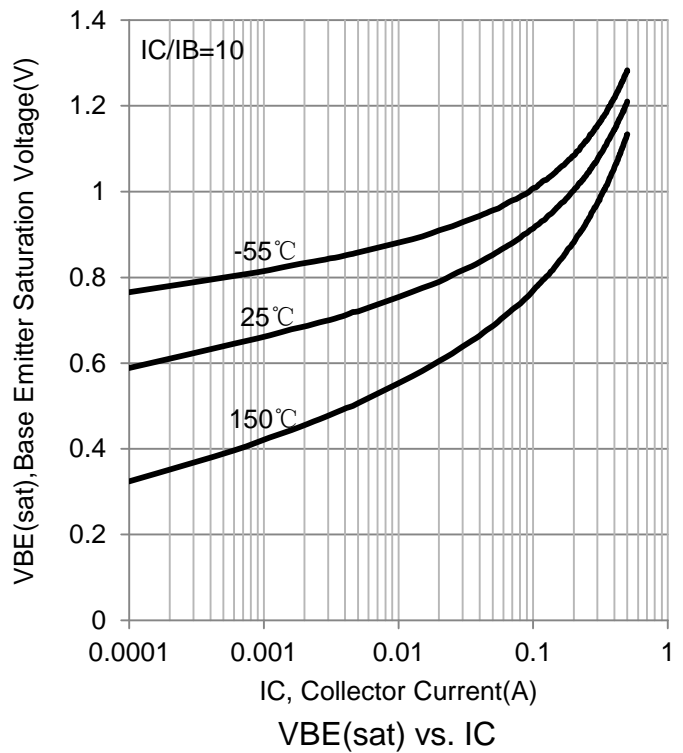
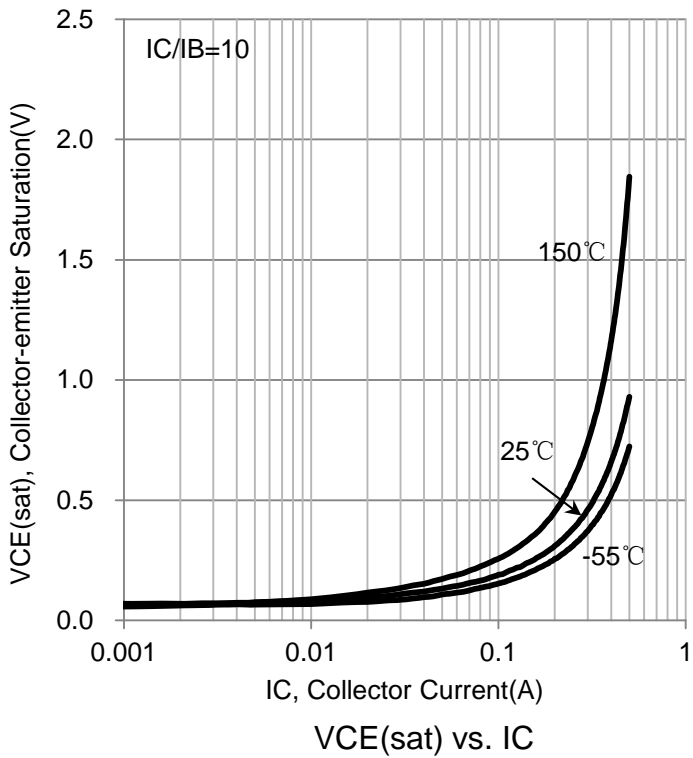
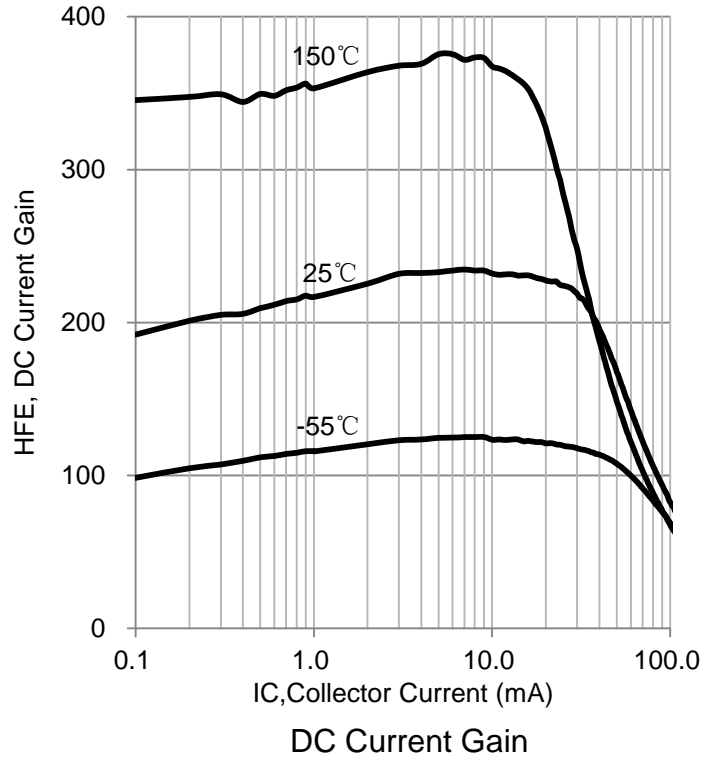
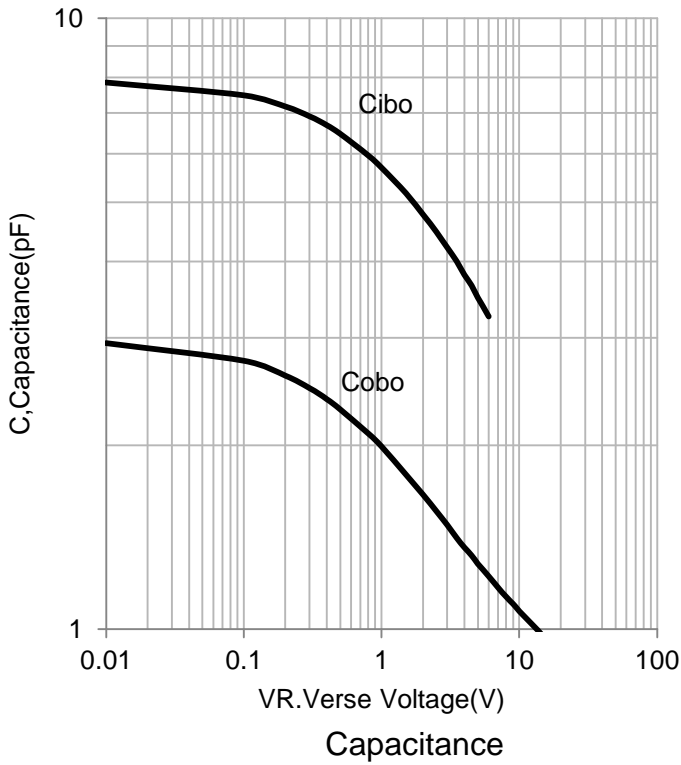

6. ELECTRICAL CHARACTERISTICS CURVES

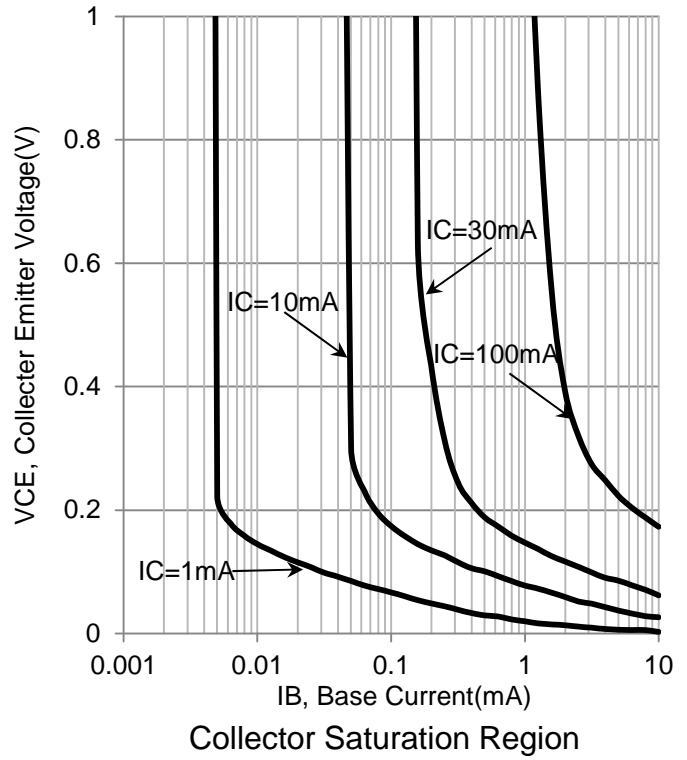
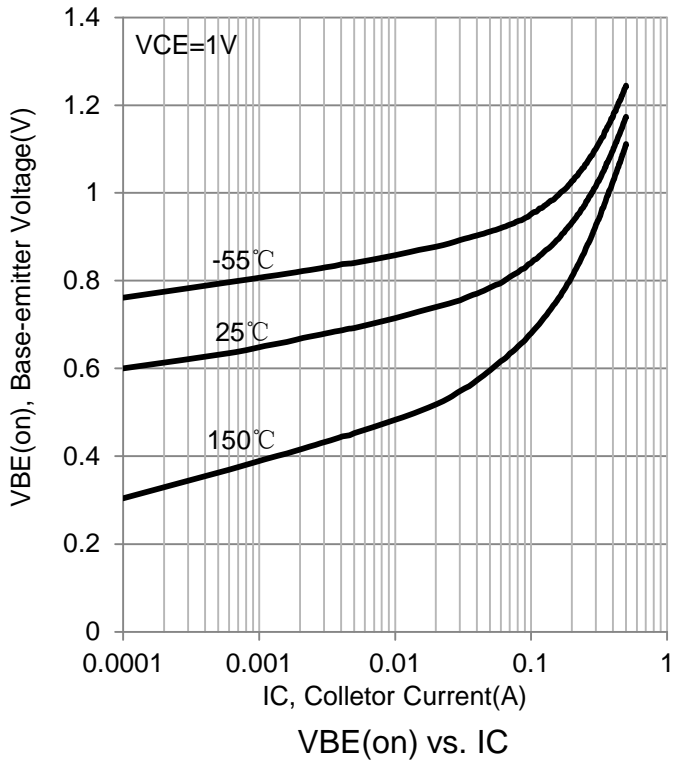

7. OUTLINE AND DIMENSIONS

Notes:

1. DIMENSIONING AND TOLERANCING PER ANSI Y14.5M, 1982.
2. CONTROLLING DIMENSION: MILLIMETERS.
3. MAXIMUM LEAD THICKNESS INCLUDES LEAD FINISH. MINIMUM LEAD THICKNESS IS THE MINIMUM THICKNESS OF BASE MATERIAL.
4. DIMENSIONS D AND E1 DO NOT INCLUDE MOLD FLASH, PROTRUSIONS OR GATE BURRS.

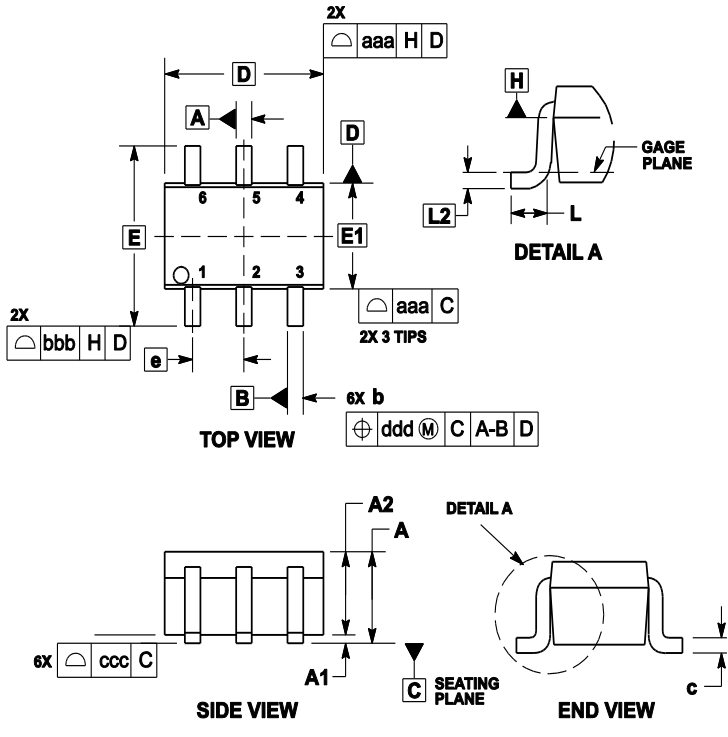

DIM	MILLIMETERS			INCHES		
	MIN	NOM	MAX	MIN	NOM	MAX
A	---	---	1.10	---	---	0.04
A1	0.00	---	0.10	0	---	0
A2	0.70	0.90	1.00	0.03	0.04	0.04
b	0.15	0.20	0.25	0.01	0.01	0.01
C	0.08	0.15	0.22	0	0.01	0.01
D	1.80	2.00	2.20	0.07	0.08	0.09
E	2.00	2.10	2.20	0.08	0.08	0.09
E1	1.15	1.25	1.35	0.05	0.05	0.05
e	0.65 BSC			0.026 BSC		
L	0.26	0.36	0.46	#####	0.01	0.02
L2	0.15 BSC			0.006 BSC		
aaa	0.15			0.01		
bbb	0.30			0.01		
ccc	0.10			0.00		
ddd	0.10			0.00		

8. SOLDERING FOOTPRINT

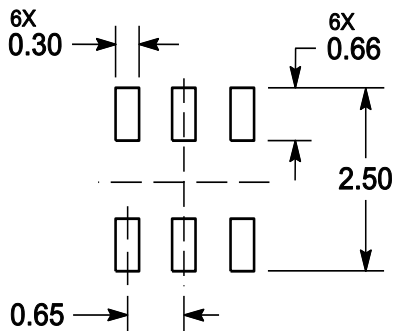

X-ON Electronics

Largest Supplier of Electrical and Electronic Components

Click to view similar products for [Bipolar Transistors - BJT category](#):

Click to view products by [Leshan manufacturer](#):

Other Similar products are found below :

[619691C](#) [MCH4017-TL-H](#) [MMBT-2369-TR](#) [BC546/116](#) [BC557/116](#) [BSW67A](#) [NJVMJD148T4G](#) [NTE123AP-10](#) [NTE153MCP](#) [NTE16](#)
[NTE195A](#) [NTE92](#) [C4460](#) [2N4401-A](#) [2N6728](#) [2SA1419T-TD-H](#) [2SA2126-E](#) [2SB1204S-TL-E](#) [2SC2712S-GR,LF](#) [2SC5488A-TL-H](#)
[2SD2150T100R](#) [SP000011176](#) [2N2907A](#) [2N3904-NS](#) [2N5769](#) [2SC2412KT146S](#) [2SD1816S-TL-E](#) [CPH6501-TL-E](#) [MCH4021-TL-E](#)
[MJE340](#) [US6T6TR](#) [NJL0281DG](#) [732314D](#) [CPH3121-TL-E](#) [CPH6021-TL-H](#) [873787E](#) [IMZ2AT108](#) [UMX21NTR](#) [MCH6102-TL-E](#)
[NJL0302DG](#) [2N3583](#) [30A02MH-TL-E](#) [NSV40301MZ4T1G](#) [NTE13](#) [NTE26](#) [NTE282](#) [NTE323](#) [NTE350](#) [NTE81](#) [STX83003-AP](#)