

High Voltage Transistor

FEATURE

- We declare that the material of product compliance with RoHS requirements.
- S- Prefix for Automotive and Other Applications Requiring Unique Site and Control Change Requirements; AEC-Q101 Qualified and PPAP Capable.

LMBT5401LT1G
S-LMBT5401LT1G

DEVICE MARKING AND ORDERING INFORMATION

Device	Marking	Shipping
LMBT5401LT1G S-LMBT5401LT1G	2L	3000/Tape&Reel
LMBT5401LT3G S-LMBT5401LT3G	2L	10000/Tape&Reel

MAXIMUM RATINGS

Rating	Symbol	Value	Unit
Collector–Emitter Voltage	V_{CEO}	- 150	Vdc
Collector–Base Voltage	V_{CBO}	- 160	Vdc
Emitter–Base Voltage	V_{EBO}	- 5.0	Vdc
Collector Current — Continuous	I_C	- 500	mAdc

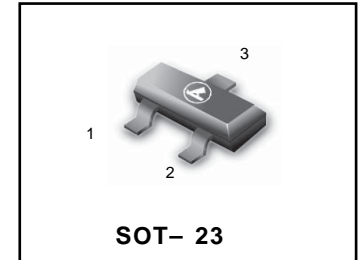

THERMAL CHARACTERISTICS

Characteristic	Symbol	Max	Unit
Total Device Dissipation FR-5 Board (1) $T_A=25^\circ\text{C}$ Derate above 25°C	P_D	225	mW
Thermal Resistance, Junction to Ambient	$R_{\theta JA}$	556	$^\circ\text{C/W}$
Total Device Dissipation Alumina Substrate, (2) $T_A = 25^\circ\text{C}$ Derate above 25°C	P_D	300	mW
Thermal Resistance, Junction to Ambient	$R_{\theta JA}$	417	$^\circ\text{C/W}$
Junction and Storage Temperature	T_J, T_{stg}	-55to+150	$^\circ\text{C}$

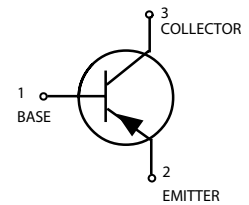

DEVICE MARKING

LMBT5401LT1G=2L

ELECTRICAL CHARACTERISTICS ($T_A = 25^\circ\text{C}$ unless otherwise noted)

Characteristic	Symbol	Min	Max	Unit
----------------	--------	-----	-----	------

OFF CHARACTERISTICS

Collector–Emitter Breakdown Voltage ($I_C = -1.0\text{ mAdc}, I_E = 0$)	$V_{(BR)CEO}$	- 150	—	Vdc
Collector–Base Breakdown Voltage ($I_C = -100\ \mu\text{Adc}, I_E = 0$)	$V_{(BR)CBO}$	- 160	—	Vdc
Emitter–Base Breakdown Voltage ($I_E = -10\ \mu\text{Adc}, I_C = 0$)	$V_{(BR)EBO}$	-5.0	—	Vdc
Collector Cutoff Current ($V_{CB} = -120\text{ Vdc}, I_E = 0$)	I_{CBO}	—	- 50	nAdc
($V_{CB} = -120\text{ Vdc}, I_E = 0, T_A = 100^\circ\text{C}$)		—	- 50	μAdc

1. FR-5 = 1.0 x 0.75 x 0.062 in.

2. Alumina = 0.4 x 0.3 x 0.024 in. 99.5% alumina.

LMBT5401LT1G , S-LMBT5401LT1G
ELECTRICAL CHARACTERISTICS ($T_A = 25^\circ\text{C}$ unless otherwise noted) (Continued)

Characteristic	Symbol	Min	Max	Unit
ON CHARACTERISTICS (2)				
DC Current Gain	h_{FE}			—
($I_C = -1.0\text{mA}$, $V_{CE} = -5.0\text{Vdc}$)		50	—	
($I_C = -10\text{mA}$, $V_{CE} = -5.0\text{Vdc}$)		60	240	
($I_C = -50\text{mA}$, $V_{CE} = -5.0\text{Vdc}$)		50	—	
Collector–Emitter Saturation Voltage	$V_{CE(sat)}$			Vdc
($I_C = -10\text{mA}$, $I_B = -1.0\text{mA}$)		—	-0.2	
($I_C = -50\text{mA}$, $I_B = -5.0\text{mA}$)		—	-0.5	
Base–Emitter Saturation Voltage	$V_{BE(sat)}$			Vdc
($I_C = -10\text{mA}$, $I_B = -1.0\text{mA}$)		—	-1.0	
($I_C = -50\text{mA}$, $I_B = -5.0\text{mA}$)		—	-1.0	
SMALL–SIGNAL CHARACTERISTICS				
Current–Gain — Bandwidth Product	f_T			MHz
($I_C = -10\text{mA}$, $V_{CE} = -10\text{Vdc}$, $f = 100\text{MHz}$)		100	300	
Output Capacitance	C_{obo}			pF
($V_{CB} = -10\text{Vdc}$, $I_E = 0$, $f = 1.0\text{MHz}$)		—	6.0	
Small–Signal Current Gain	h_{fe}			—
($I_C = -1.0\text{mA}$, $V_{CE} = -10\text{Vdc}$, $f = 1.0\text{kHz}$)		40	200	
Noise Figure	NF			dB
($I_C = -200\mu\text{A}$, $V_{CE} = -5.0\text{Vdc}$, $R_s = 10\Omega$, $f = 1.0\text{kHz}$)		—	8.0	

LMBT5401LT1G , S-LMBT5401LT1G

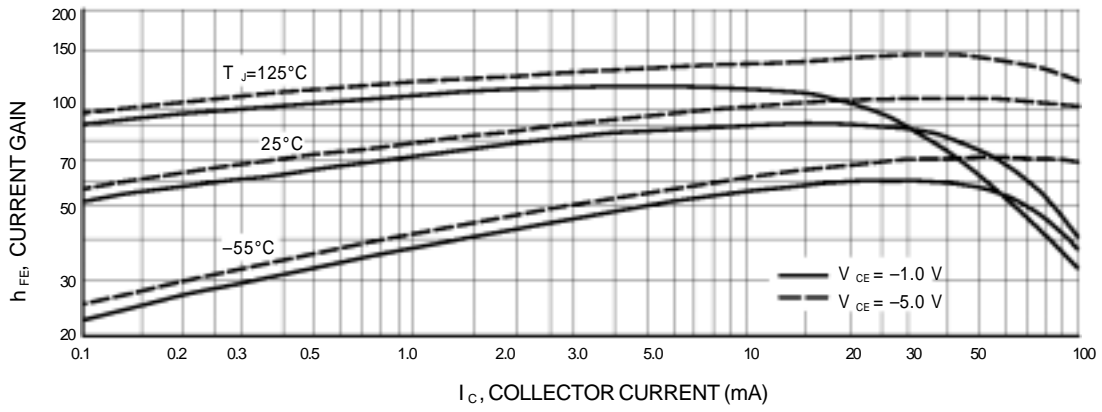

Figure 1. DC Current Gain

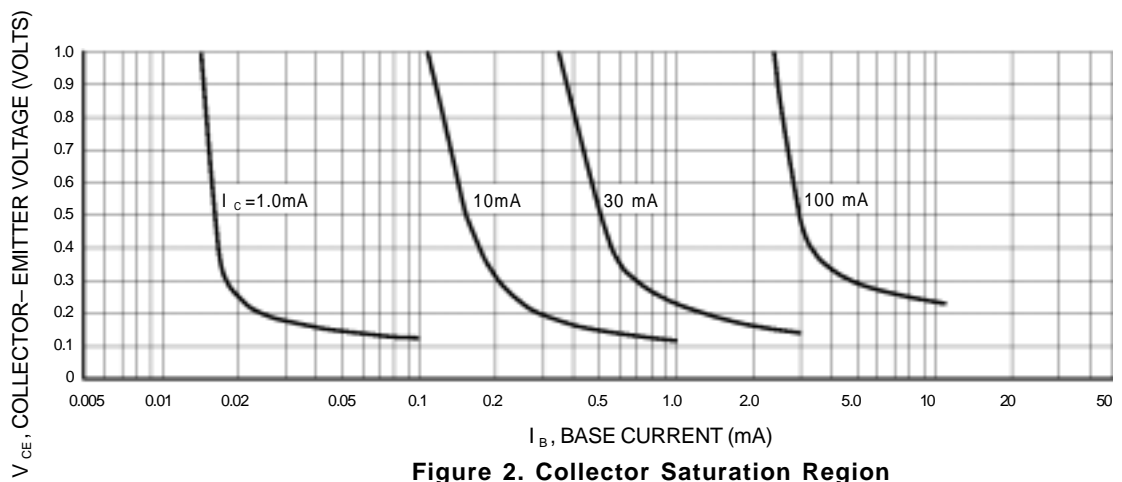

Figure 2. Collector Saturation Region

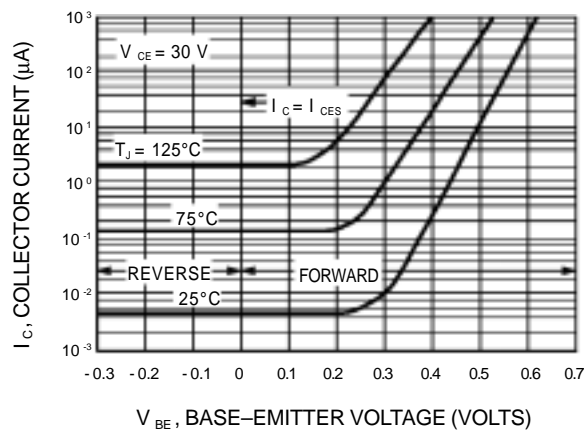

Figure 3. Collector Cut-Off Region

LMBT5401LT1G , S-LMBT5401LT1G

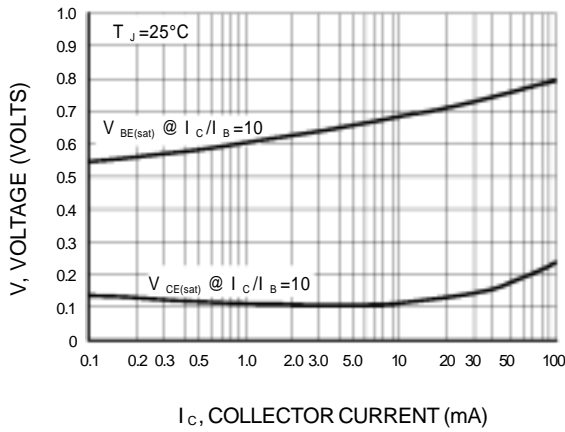

Figure 4. "On" Voltages

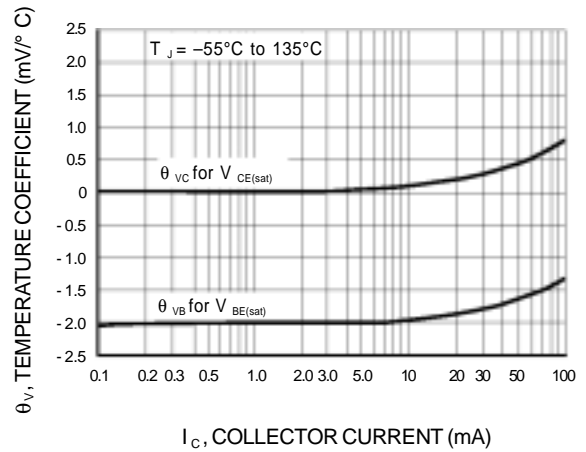

Figure 5. Temperature Coefficients

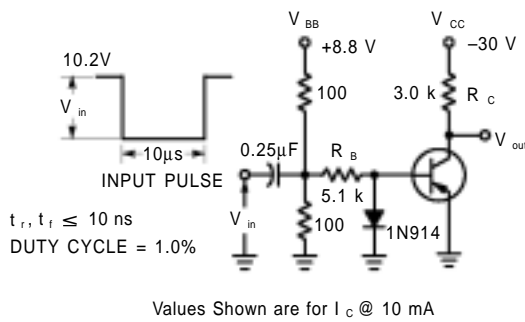

Figure 6. Switching Time Test Circuit

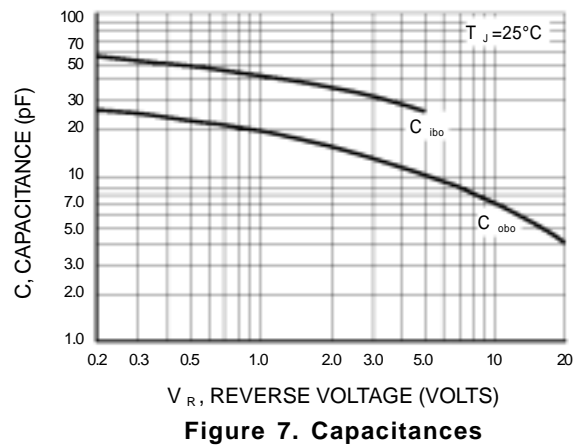

Figure 7. Capacitances

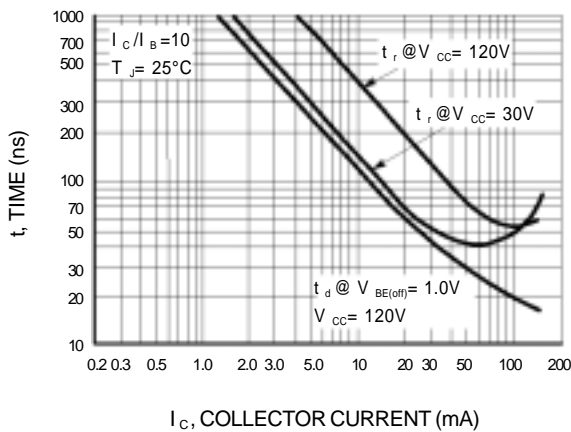

Figure 8. Turn-On Time

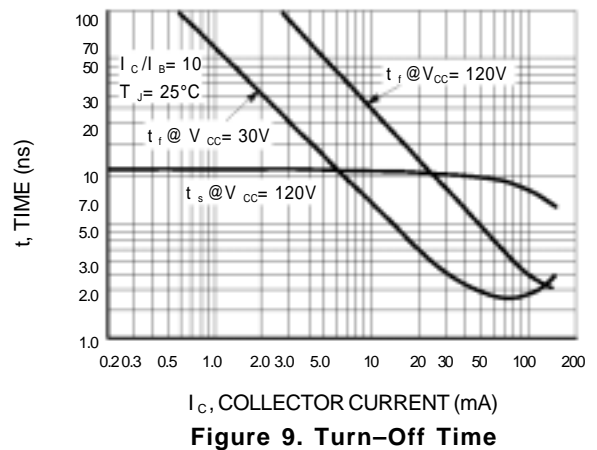
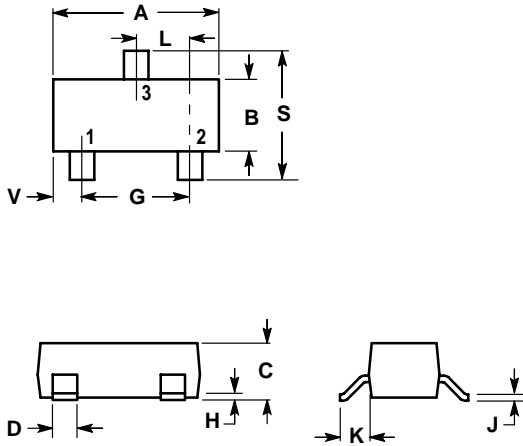

Figure 9. Turn-Off Time

LMBT5401LT1G , S-LMBT5401LT1G

SOT-23



NOTES:

1. DIMENSIONING AND TOLERANCING PER ANSI Y14.5M, 1982.
2. CONTROLLING DIMENSION: INCH.

DIM	INCHES		MILLIMETERS	
	MIN	MAX	MIN	MAX
A	0.1102	0.1197	2.80	3.04
B	0.0472	0.0551	1.20	1.40
C	0.0350	0.0440	0.89	1.11
D	0.0150	0.0200	0.37	0.50
G	0.0701	0.0807	1.78	2.04
H	0.0005	0.0040	0.013	0.100
J	0.0034	0.0070	0.085	0.177
K	0.0140	0.0285	0.35	0.69
L	0.0350	0.0401	0.89	1.02
S	0.0830	0.1039	2.10	2.64
V	0.0177	0.0236	0.45	0.60

- PIN 1. BASE
 2. EMITTER
 3. COLLECTOR

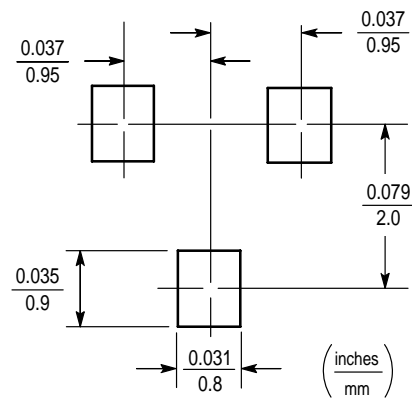

X-ON Electronics

Largest Supplier of Electrical and Electronic Components

Click to view similar products for [Bipolar Transistors - BJT category](#):

Click to view products by [Leshan manufacturer](#):

Other Similar products are found below :

[619691C](#) [MCH4017-TL-H](#) [MMBT-2369-TR](#) [BC546/116](#) [BC557/116](#) [BSW67A](#) [NJVMJD148T4G](#) [NTE123AP-10](#) [NTE153MCP](#) [NTE16](#)
[NTE195A](#) [NTE92](#) [C4460](#) [2N4401-A](#) [2N6728](#) [2SA1419T-TD-H](#) [2SA2126-E](#) [2SB1204S-TL-E](#) [2SC2712S-GR,LF](#) [2SC5488A-TL-H](#)
[2SD2150T100R](#) [SP000011176](#) [2N2907A](#) [2N3904-NS](#) [2N5769](#) [2SC2412KT146S](#) [2SD1816S-TL-E](#) [CPH6501-TL-E](#) [MCH4021-TL-E](#)
[MJE340](#) [US6T6TR](#) [NJL0281DG](#) [732314D](#) [CPH3121-TL-E](#) [CPH6021-TL-H](#) [873787E](#) [IMZ2AT108](#) [UMX21NTR](#) [MCH6102-TL-E](#)
[NJL0302DG](#) [2N3583](#) [30A02MH-TL-E](#) [NSV40301MZ4T1G](#) [NTE13](#) [NTE26](#) [NTE282](#) [NTE323](#) [NTE350](#) [NTE81](#) [STX83003-AP](#)