

# Bias Resistor Transistor

## NPN Silicon Surface Mount Transistor with Monolithic Bias Resistor Network

This new series of digital transistors is designed to replace a single device and its external resistor bias network. The BRT (Bias Resistor Transistor) contains a single transistor with a monolithic bias network consisting of two resistors; a series base resistor and a base-emitter resistor. The BRT eliminates these individual components by integrating them into a single device. The use of a BRT can reduce both system cost and board space. The device is housed in the SC-70/SOT-323 package which is designed for low power surface mount applications.

- Simplifies Circuit Design
- Reduces Board Space
- Reduces Component Count
- The SC-70/SOT-323 package can be soldered using wave or reflow. The modified gull-winged leads absorb thermal stress during soldering eliminating the possibility of damage to the die.
- Available in 8 mm embossed tape and reel  
Use the Device Number to order the 7 inch/3000 unit reel.
- Pb-Free package is available
- S- Prefix for Automotive and Other Applications Requiring Unique Site and Control Change Requirements; AEC-Q101 Qualified and PPAP Capable.

### DEVICE MARKING INFORMATION

See specific marking information in the device marking table on page 2 of this data sheet.

### MAXIMUM RATINGS ( $T_A = 25^\circ\text{C}$ unless otherwise noted)

Rating	Symbol	Value	Unit
Collector-Base Voltage	$V_{CBO}$	50	Vdc
Collector-Emitter Voltage	$V_{CEO}$	50	Vdc
Collector Current	$I_C$	100	mAdc

### THERMAL CHARACTERISTICS

Characteristic	Symbol	Max	Unit
Total Device Dissipation $T_A = 25^\circ\text{C}$ Derate above $25^\circ\text{C}$	$P_D$	202 (Note 1.) 310 (Note 2.) 1.6 (Note 1.) 2.5 (Note 2.)	mW mW/ $^\circ\text{C}$
Thermal Resistance – Junction-to-Ambient	$R_{\theta JA}$	618 (Note 1.) 403 (Note 2.)	$^\circ\text{C}/\text{W}$
Thermal Resistance – Junction-to-Lead	$R_{\theta JL}$	280 (Note 1.) 332 (Note 2.)	$^\circ\text{C}/\text{W}$
Junction and Storage Temperature Range	$T_J, T_{stg}$	-55 to +150	$^\circ\text{C}$

1. FR-4 @ Minimum Pad
2. FR-4 @ 1.0 x 1.0 inch Pad

## LMUN5211T1G Series S-LMUN5211T1G Series

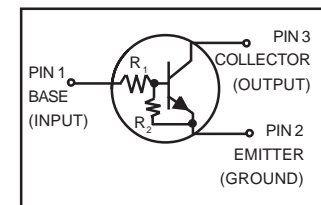
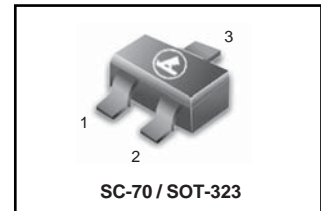

### MARKING DIAGRAM

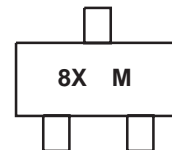

8x = Specific Device Code  
x = (See Marking Table)  
M = Date Code

LMUN5211T1G Series ;S-LMUN5211T1G Series

DEVICE MARKING RESISTOR VALUES AND ORDERING INFORMATION

Device	Package	Marking	R1(K)	R2(K)	Shipping
LMUN5211T1G	SC-70/SOT-323	8A	10	10	3000/Tape&Reel
LMUN5211T3G	SC-70/SOT-323	8A	10	10	10000/Tape&Reel
LMUN5212T1G	SC-70/SOT-323	8B	22	22	3000/Tape&Reel
LMUN5212T3G	SC-70/SOT-323	8B	22	22	10000/Tape&Reel
LMUN5213T1G	SC-70/SOT-323	8C	47	47	3000/Tape&Reel
LMUN5213T3G	SC-70/SOT-323	8C	47	47	10000/Tape&Reel
LMUN5214T1G	SC-70/SOT-323	8D	10	47	3000/Tape&Reel
LMUN5214T3G	SC-70/SOT-323	8D	10	47	10000/Tape&Reel
LMUN5215T1G(Note 3)	SC-70/SOT-323	8E	10	∞	3000/Tape&Reel
LMUN5215T3G	SC-70/SOT-323	8E	10	∞	10000/Tape&Reel
LMUN5216T1G(Note 3)	SC-70/SOT-323	8F	4.7	∞	3000/Tape&Reel
LMUN5216T3G	SC-70/SOT-323	8F	4.7	∞	10000/Tape&Reel
LMUN5230T1G(Note 3)	SC-70/SOT-323	8G	1	1	3000/Tape&Reel
LMUN5230T3G	SC-70/SOT-323	8G	1	1	10000/Tape&Reel
LMUN5231T1G(Note 3)	SC-70/SOT-323	8H	2.2	2.2	3000/Tape&Reel
LMUN5231T3G	SC-70/SOT-323	8H	2.2	2.2	10000/Tape&Reel
LMUN5232T1G(Note 3)	SC-70/SOT-323	8J	4.7	4.7	3000/Tape&Reel
LMUN5232T3G	SC-70/SOT-323	8J	4.7	4.7	10000/Tape&Reel
LMUN5233T1G(Note 3)	SC-70/SOT-323	8K	4.7	47	3000/Tape&Reel
LMUN5233T3G	SC-70/SOT-323	8K	4.7	47	10000/Tape&Reel
LMUN5234T1G(Note 3)	SC-70/SOT-323	8L	22	47	3000/Tape&Reel
LMUN5234T3G	SC-70/SOT-323	8L	22	47	10000/Tape&Reel
LMUN5235T1G(Note 3)	SC-70/SOT-323	8M	2.2	47	3000/Tape&Reel
LMUN5235T3G	SC-70/SOT-323	8M	2.2	47	10000/Tape&Reel
LMUN5236T1G(Note 3)	SC-70/SOT-323	8N	100	100	3000/Tape&Reel
LMUN5236T3G	SC-70/SOT-323	8N	100	100	10000/Tape&Reel
LMUN5237T1G(Note 3)	SC-70/SOT-323	8P	47	22	3000/Tape&Reel
LMUN5237T3G	SC-70/SOT-323	8P	47	22	10000/Tape&Reel

3. New devices. Updated curves to follow in subsequent data sheets.

**ELECTRICAL CHARACTERISTICS** ( $T_A = 25^\circ\text{C}$  unless otherwise noted)

Characteristic	Symbol	Min	Typ	Max	Unit	
<b>OFF CHARACTERISTICS</b>						
Collector-Base Cutoff Current ( $V_{CB} = 50\text{ V}$ , $I_E = 0$ )	$I_{CBO}$	–	–	100	nAdc	
Collector-Emitter Cutoff Current ( $V_{CE} = 50\text{ V}$ , $I_B = 0$ )	$I_{CEO}$	–	–	500	nAdc	
Emitter-Base Cutoff Current ( $V_{EB} = 6.0\text{ V}$ , $I_C = 0$ )	LMUN5211T1G	–	–	0.5	mAdc	
	LMUN5212T1G	–	–	0.2		
	LMUN5213T1G	–	–	0.1		
	LMUN5214T1G	–	–	0.2		
	LMUN5215T1G	–	–	0.9		
	LMUN5216T1G	–	–	1.9		
	LMUN5230T1G	–	–	4.3		
	LMUN5231T1G	–	–	2.3		
	LMUN5232T1G	–	–	1.5		
	LMUN5233T1G	–	–	0.18		
	LMUN5234T1G	–	–	0.13		
	LMUN5235T1G	–	–	0.2		
	LMUN5236T1G	–	–	0.05		
LMUN5237T1G	–	–	0.13			
Collector-Base Breakdown Voltage ( $I_C = 10\text{ }\mu\text{A}$ , $I_E = 0$ )	$V_{(BR)CBO}$	50	–	–	Vdc	
Collector-Emitter Breakdown Voltage (Note 4.) ( $I_C = 2.0\text{ mA}$ , $I_B = 0$ )	$V_{(BR)CEO}$	50	–	–	Vdc	
<b>ON CHARACTERISTICS</b> (Note 4.)						
DC Current Gain ( $V_{CE} = 10\text{ V}$ , $I_C = 5.0\text{ mA}$ )	LMUN5211T1G	$h_{FE}$	35	60	220	
	LMUN5212T1G		60	100	–	
	LMUN5213T1G		80	140	320	
	LMUN5214T1G		80	140	–	
	LMUN5215T1G		160	350	–	
	LMUN5216T1G		160	350	–	
	LMUN5230T1G		3.0	5.0	–	
	LMUN5231T1G		8.0	15	–	
	LMUN5232T1G		15	30	–	
	LMUN5233T1G		80	200	–	
	LMUN5234T1G		80	150	–	
	LMUN5235T1G		80	140	–	
	LMUN5236T1G		80	150	–	
LMUN5237T1G		80	140	–		
Collector-Emitter Saturation Voltage ( $I_C = 10\text{ mA}$ , $I_B = 0.3\text{ mA}$ ) ( $I_C = 10\text{ mA}$ , $I_B = 5\text{ mA}$ ) LMUN5230T1/LMUN5231T1 ( $I_C = 10\text{ mA}$ , $I_B = 1\text{ mA}$ ) LMUN5215T1/LMUN5216T1/ LMUN5232T1/LMUN5233T1/LMUN5234T1	$V_{CE(sat)}$	–	–	0.25	Vdc	
Output Voltage ( $on$ ) ( $V_{CC} = 5.0\text{ V}$ , $V_B = 2.5\text{ V}$ , $R_L = 1.0\text{ k}\Omega$ )	LMUN5211T1G	$V_{OL}$	–	–	0.2	Vdc
	LMUN5212T1G		–	–	0.2	
	LMUN5214T1G		–	–	0.2	
	LMUN5215T1G		–	–	0.2	
	LMUN5216T1G		–	–	0.2	
	LMUN5230T1G		–	–	0.2	
	LMUN5231T1G		–	–	0.2	
	LMUN5232T1G		–	–	0.2	
	LMUN5233T1G		–	–	0.2	
	LMUN5234T1G		–	–	0.2	
	LMUN5235T1G		–	–	0.2	
	( $V_{CC} = 5.0\text{ V}$ , $V_B = 3.5\text{ V}$ , $R_L = 1.0\text{ k}\Omega$ ) LMUN5213T1G		–	–	0.2	
	( $V_{CC} = 5.0\text{ V}$ , $V_B = 5.5\text{ V}$ , $R_L = 1.0\text{ k}\Omega$ ) LMUN5236T1G		–	–	0.2	
( $V_{CC} = 5.0\text{ V}$ , $V_B = 4.0\text{ V}$ , $R_L = 1.0\text{ k}\Omega$ ) LMUN5237T1G		–	–	0.2		

4. Pulse Test: Pulse Width < 300  $\mu\text{s}$ , Duty Cycle < 2.0%

LMUN5211T1G Series ;S-LMUN5211T1G Series

**ELECTRICAL CHARACTERISTICS** ( $T_A = 25^\circ\text{C}$  unless otherwise noted) (Continued)

Characteristic	Symbol	Min	Typ	Max	Unit
<b>ON CHARACTERISTICS</b> (Note 5.) (Continued)					
Output Voltage (off) ( $V_{CC} = 5.0\text{ V}$ , $V_B = 0.5\text{ V}$ , $R_L = 1.0\text{ k}\Omega$ ) ( $V_{CC} = 5.0\text{ V}$ , $V_B = 0.050\text{ V}$ , $R_L = 1.0\text{ k}\Omega$ ) ( $V_{CC} = 5.0\text{ V}$ , $V_B = 0.25\text{ V}$ , $R_L = 1.0\text{ k}\Omega$ )	$V_{OH}$	4.9	–	–	Vdc
Input Resistor	$R_1$	7.0	10	13	$\text{k}\Omega$
Resistor Rati	$R_1/R_2$	0.8	1.0	1.2	

5. Pulse Test: Pulse Width < 300  $\mu\text{s}$ , Duty Cycle < 2.0%

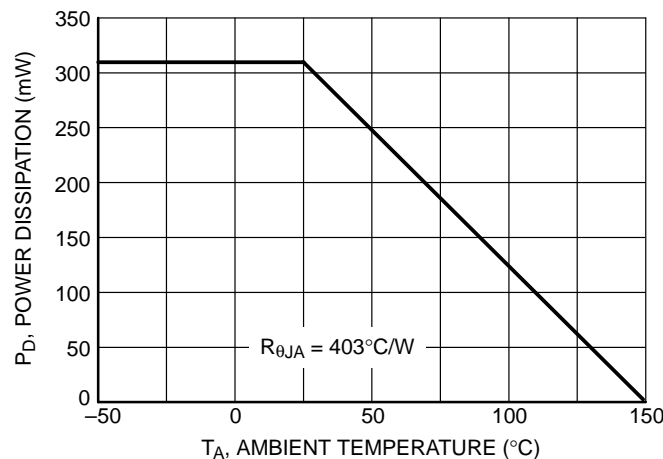

Figure 1. Derating Curve

LMUN5211T1G Series ;S-LMUN5211T1G Series

TYPICAL ELECTRICAL CHARACTERISTICS – LMUN5211T1G

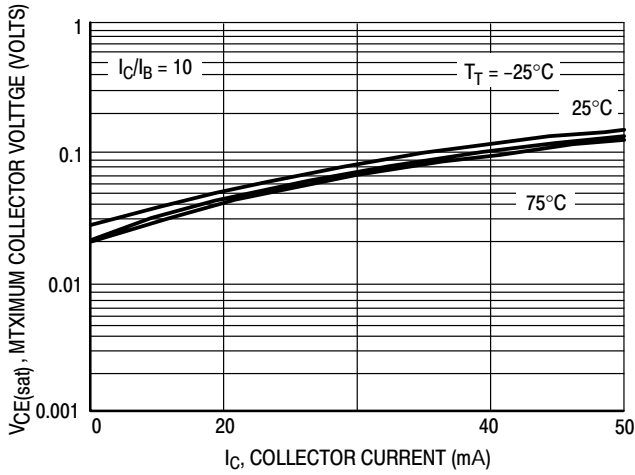

Figure 2.  $V_{CE(sat)}$  versus  $I_C$

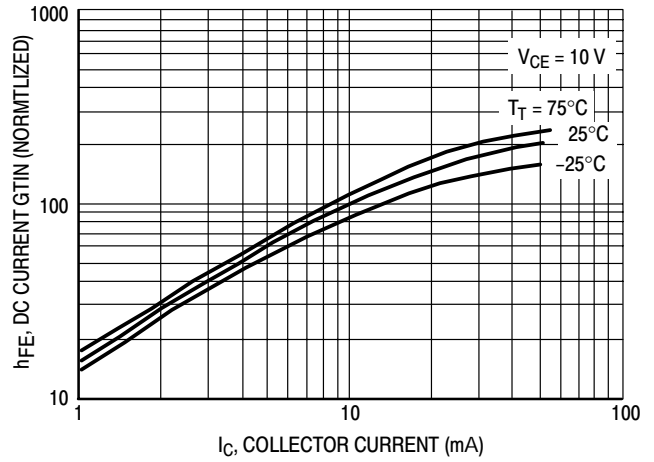

Figure 3. DC Current Gain

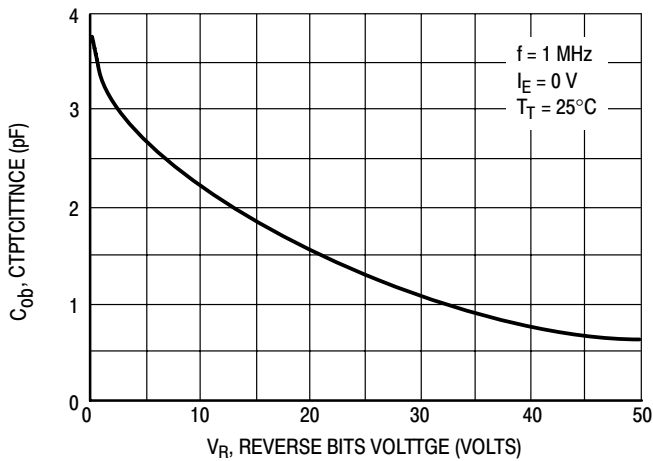

Figure 4. Output Capacitance

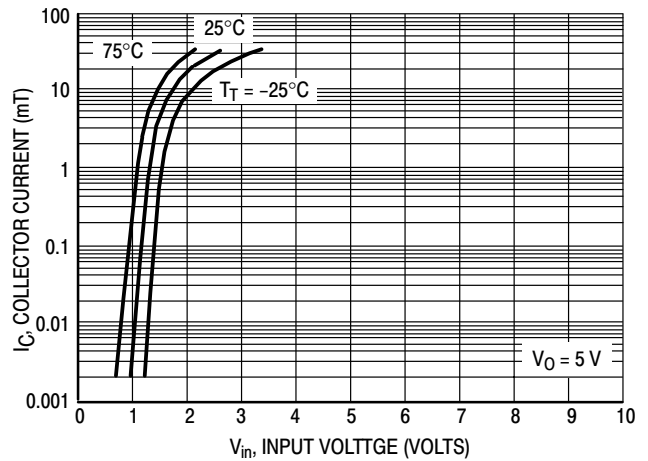

Figure 5. Output Current versus Input Voltage

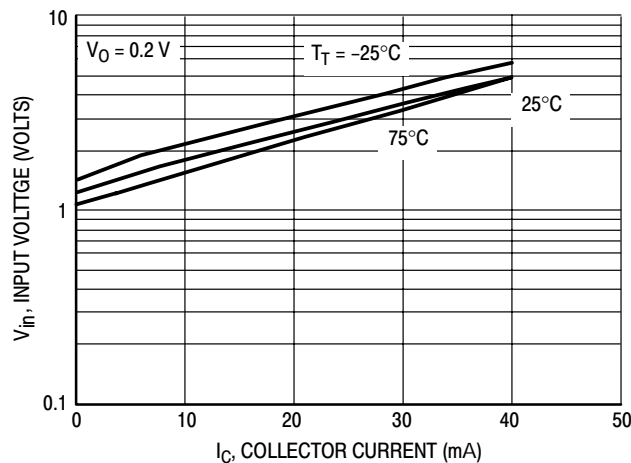

Figure 6. Input Voltage versus Output Current

LMUN5211T1G Series ;S-LMUN5211T1G Series

TYPICAL ELECTRICAL CHARACTERISTICS – LMUN5212T1G

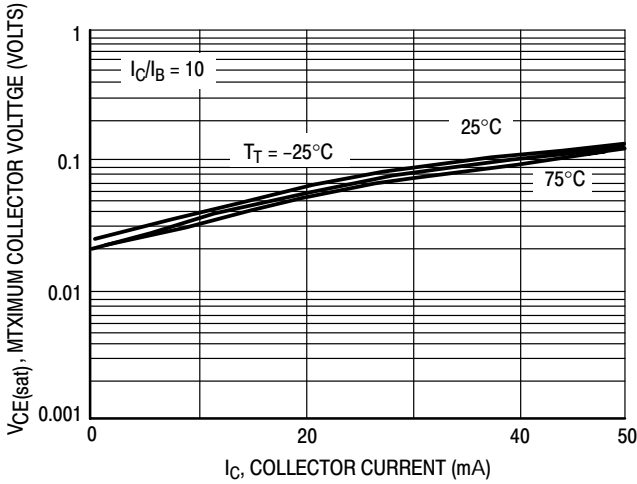

Figure 7.  $V_{CE(sat)}$  versus  $I_C$

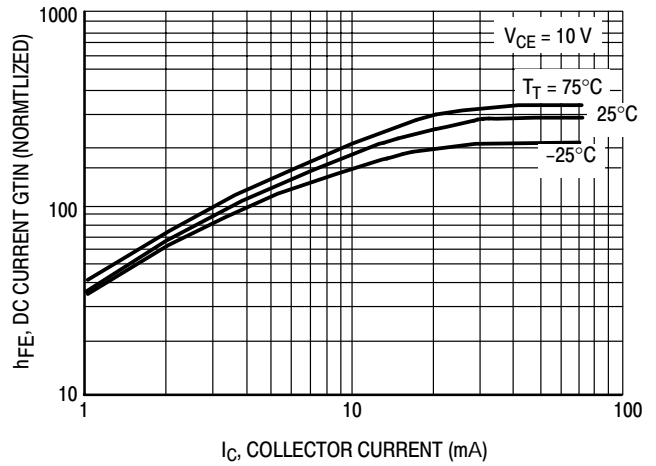

Figure 8. DC Current Gain

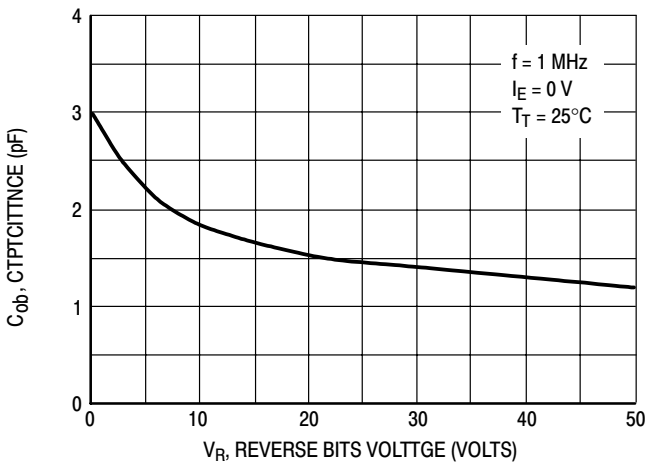

Figure 9. Output Capacitance

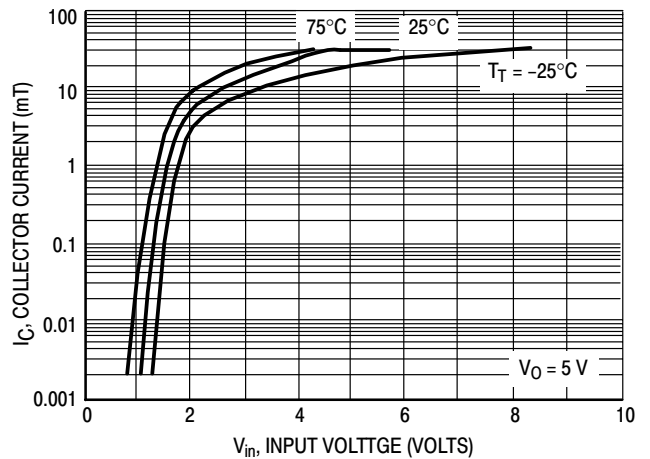

Figure 10. Output Current versus Input Voltage

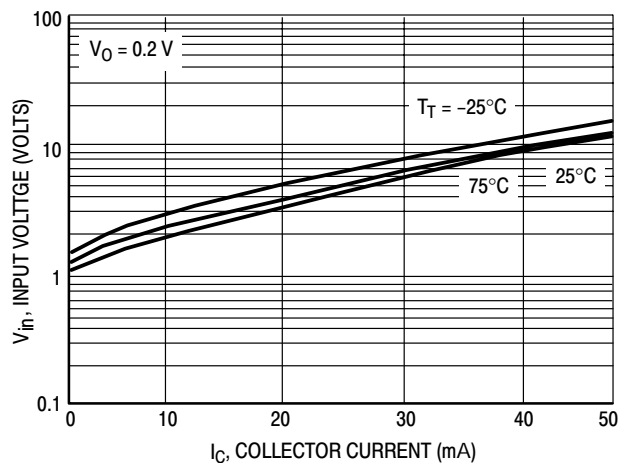

Figure 11. Input Voltage versus Output Current

LMUN5211T1G Series ;S-LMUN5211T1G Series

TYPICAL ELECTRICAL CHARACTERISTICS – LMUN5213T1G

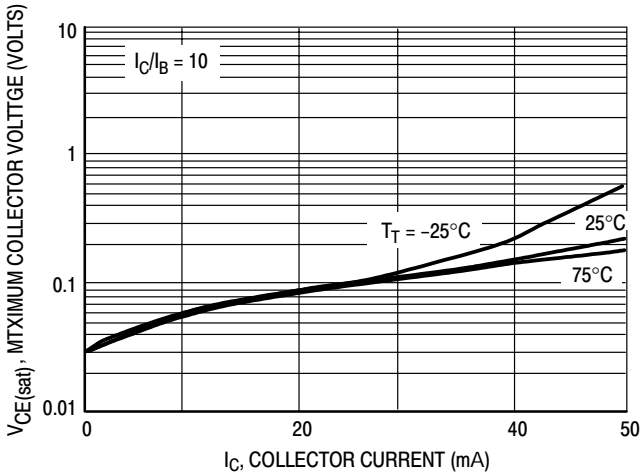

Figure 12.  $V_{CE(sat)}$  versus  $I_C$

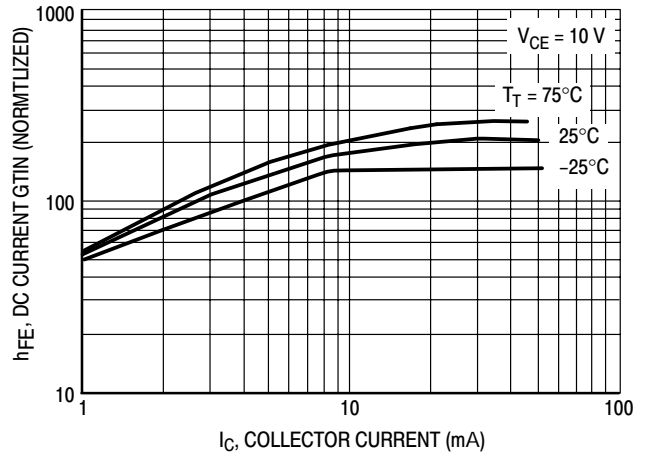

Figure 13. DC Current Gain

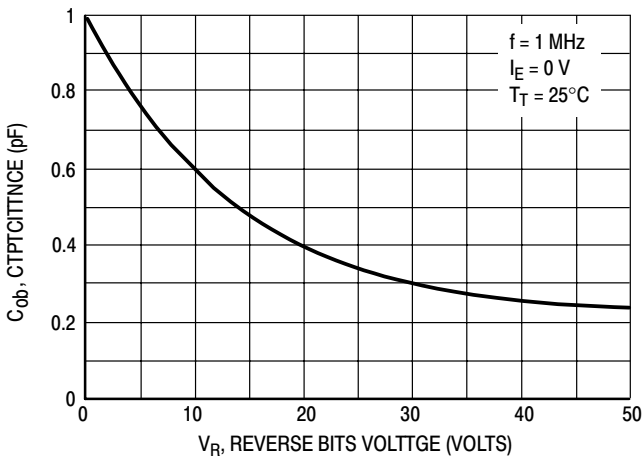

Figure 14. Output Capacitance

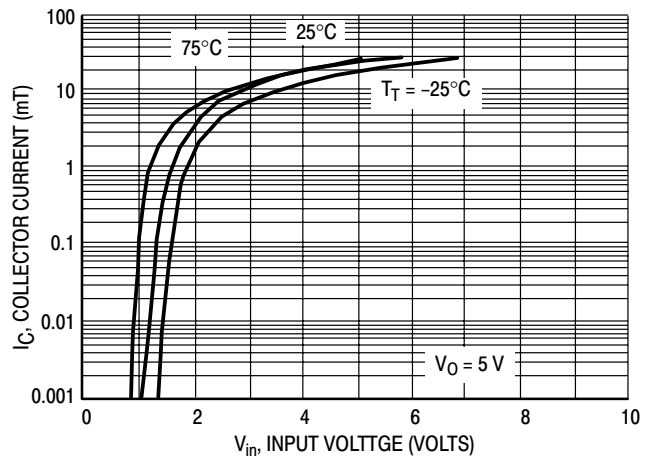

Figure 15. Output Current versus Input Voltage

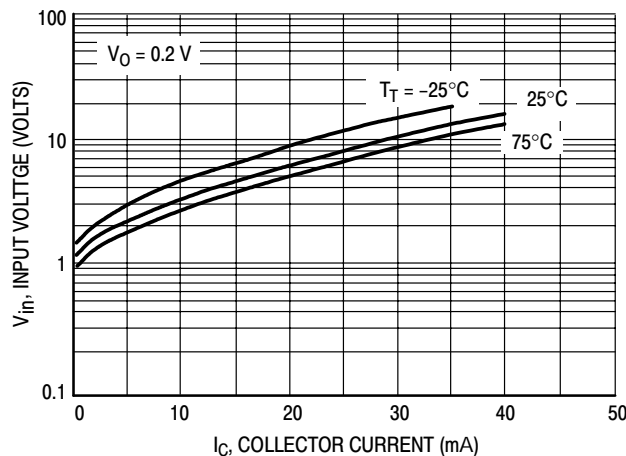

Figure 16. Input Voltage versus Output Current

LMUN5211T1G Series ;S-LMUN5211T1G Series  
 TYPICAL ELECTRICAL CHARACTERISTICS – LMUN5214T1G

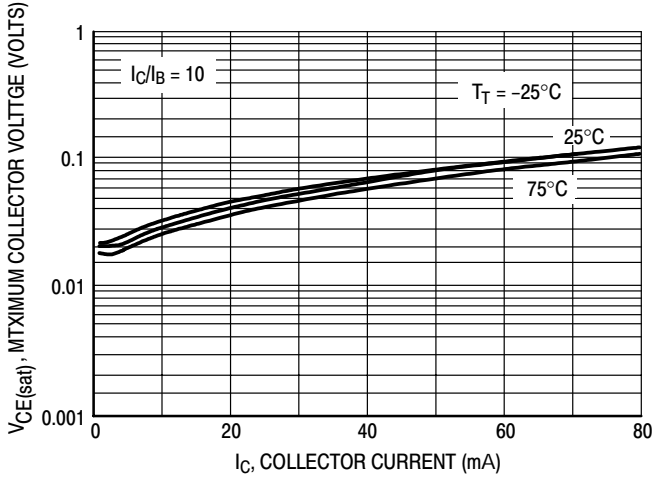

Figure 17.  $V_{CE(sat)}$  versus  $I_C$

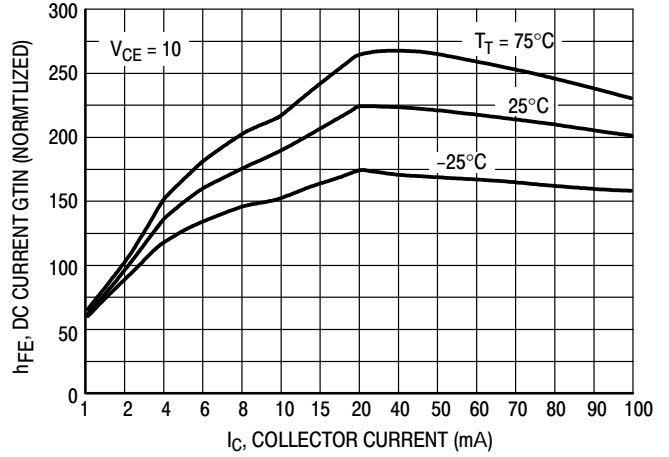

Figure 18. DC Current Gain

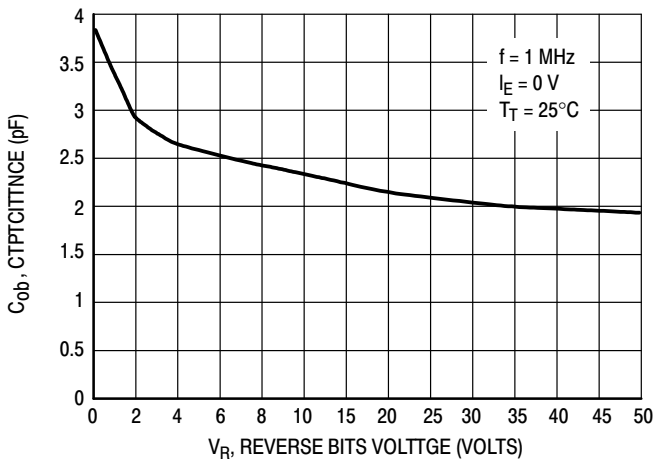

Figure 19. Output Capacitance

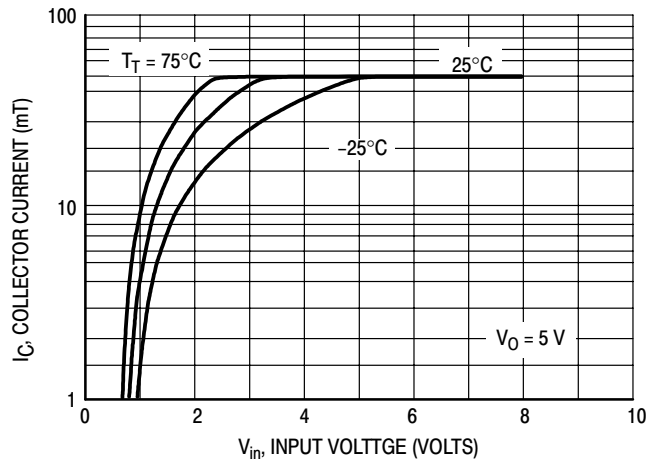

Figure 20. Output Current versus Input Voltage

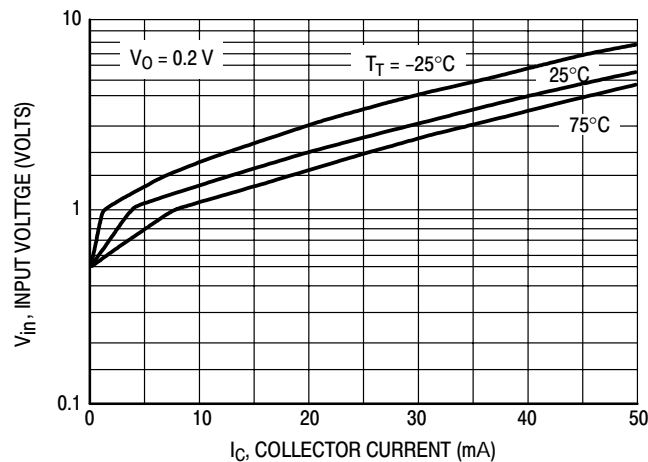

Figure 21. Input Voltage versus Output Current



LMUN5211T1G Series ;S-LMUN5211T1G Series

TYPICAL APPLICATIONS FOR NPN BRTs

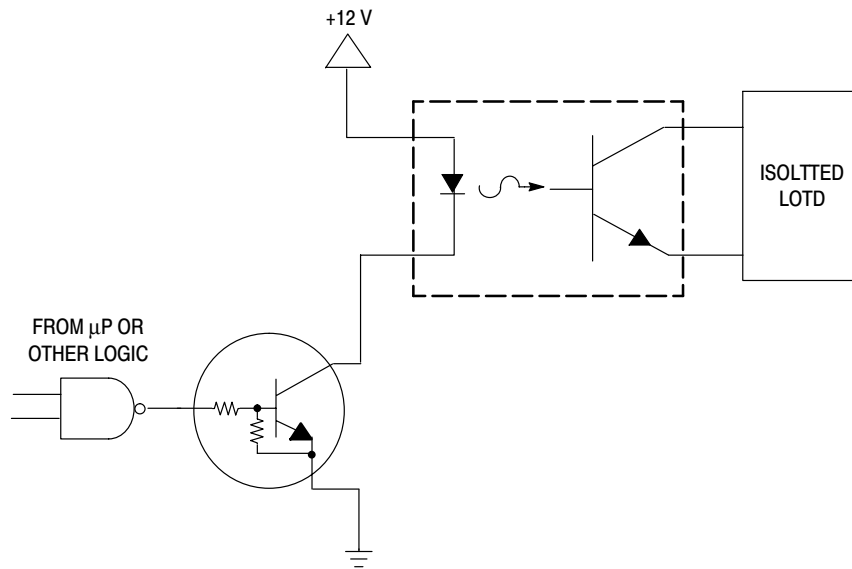

Figure 22. Level Shifter: Connects 12 or 24 Volt Circuits to Logic

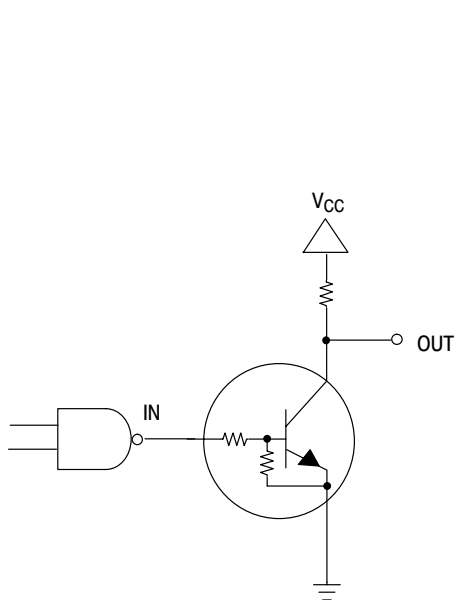

Figure 23. Open Collector Inverter: Inverts the Input Signal

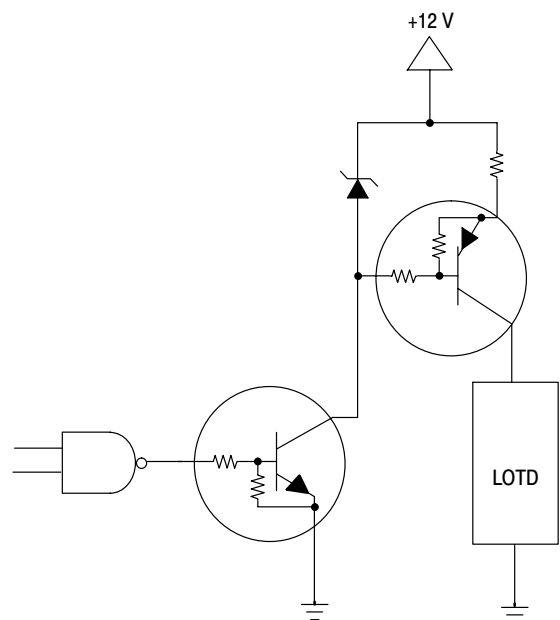

Figure 24. Inexpensive, Unregulated Current Source

LMUN5211T1G Series ;S-LMUN5211T1G Series

SC-70 / SOT-323

NOTES:

1. DIMENSIONING AND TOLERANCING PER ANSI Y14.5M, 1982.
2. CONTROLLING DIMENSION: INCH.

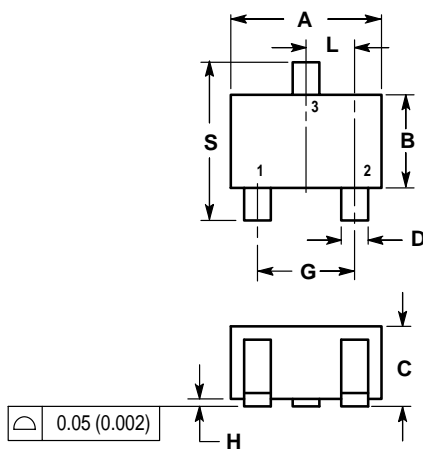

DIM	INCHES		MILLIMETERS	
	MIN	MAX	MIN	MAX
A	0.071	0.087	1.80	2.20
B	0.045	0.053	1.15	1.35
C	0.032	0.040	0.80	1.00
D	0.012	0.016	0.30	0.40
G	0.047	0.055	1.20	1.40
H	0.000	0.004	0.00	0.10
J	0.004	0.010	0.10	0.25
K	0.017 REF		0.425 REF	
L	0.026 BSC		0.650 BSC	
N	0.028 REF		0.700 REF	
S	0.079	0.095	2.00	2.40

- PIN 1. BASE  
 2. EMITTER  
 3. COLLECTOR

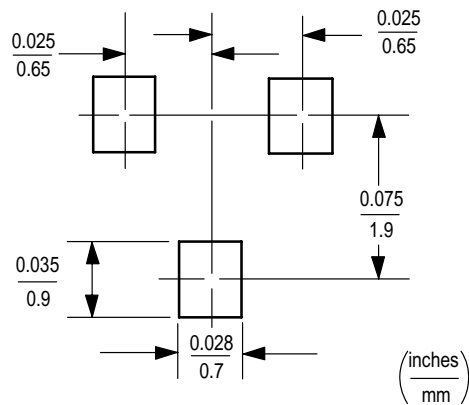

## X-ON Electronics

Largest Supplier of Electrical and Electronic Components

*Click to view similar products for [Bipolar Transistors - Pre-Biased](#) category:*

*Click to view products by [Leshan](#) manufacturer:*

Other Similar products are found below :

[DRC9A14E0L](#) [DTA124GKAT146](#) [DTA144WETL](#) [DTA144WKAT146](#) [DTC113EET1G](#) [DTC115TETL](#) [DTC115TKAT146](#)  
[DTC144VUAT106](#) [MUN5241T1G](#) [BCR158WH6327XTSA1](#) [NSBA114TDP6T5G](#) [SMUN5330DW1T1G](#) [SSVMUN5312DW1T2G](#)  
[RN1303\(TE85L,F\)](#) [RN1306\(TE85L,F\)](#) [EMH15T2R](#) [SMUN2214T3G](#) [SMUN5335DW1T1G](#) [NSBC143ZPDP6T5G](#) [NSVDTA143ZET1G](#)  
[SMUN2214T1G](#) [FMA7AT148](#) [DTC114EUA-TP](#) [SMUN5237DW1T1G](#) [SMUN5213DW1T1G](#) [SMUN5114DW1T1G](#) [SMUN2111T1G](#)  
[DTC124ECA-TP](#) [DTA114ECA-TP](#) [DTC113EM3T5G](#) [NSVMUN5135DW1T1G](#) [NSVMUN2237T1G](#) [NSVDTC143ZM3T5G](#)  
[SMUN5335DW1T2G](#) [SMUN5216DW1T1G](#) [NSVMUN5316DW1T1G](#) [NSVMUN5215DW1T1G](#) [NSVMUN5213DW1T3G](#)  
[NSVMUN2112T1G](#) [NSVIMD10AMT1G](#) [NSVEMC2DXV5T1G](#) [NSVDTC144WET1G](#) [NSVDTC123JET1G](#) [NSVDTA143EM3T5G](#)  
[NSVB1706DMW5T1G](#) [NSBC143EDP6T5G](#) [RN2101,LF\(CT](#) [NSBA144WDXV6T1G](#) [DTA115TET1G](#) [NSBC115TDP6T5G](#)