

# LN2308LT1G

## 60V N-Channel Enhancement-Mode MOSFET

### 1. FEATURES

- VDS= 60V
- RDS(ON)  $\leq$  100m $\Omega$  @VGS =10V
- RDS(ON)  $\leq$  130m $\Omega$  @VGS =4.5V
- Super high density cell design for extremely low RDS(ON).
- Exceptional on-resistance and maximum DC current capability.
- We declare that the material of product compliance with RoHS requirements and Halogen Free.

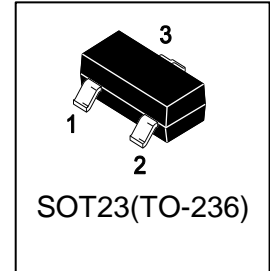

### 2. APPLICATIONS

- Power Management in Note book
- Portable Equipment
- Battery Powered System
- Load Switch
- DSC

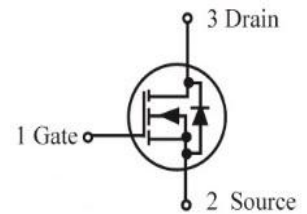

### 3. DEVICE MARKING AND ORDERING INFORMATION

Device	Marking	Shipping
LN2308LT1G	N08	3000/Tape&Reel
LN2308LT3G	N08	10000/Tape&Reel

### 4. MAXIMUM RATINGS(Ta = 25°C)

Parameter	Symbol	Limits	Unit
Drain-Source Voltage	VDSS	60	V
Gate-Source Voltage	VGS	$\pm$ 20	V
Continuous Drain Current(Tj=150°C)	ID	TA =25°C	2.6
		TA =70°C	1.8
Pulsed Drain Current	IDM	8	A
Maximum Body-Diode Continuous Current	IS	1.6	

## 5. THERMAL CHARACTERISTICS

Parameter		Symbol	Limits	Unit
Maximum Power Dissipation	TA =25°C	PD	0.7	W
	TA =70°C		0.45	
Operating Junction Temperature		TJ	150	°C
Maximum Junction-to-Ambient	T ≤10 sec	RθJA	150	°C/W
	Steady State		175	
Thermal Resistance-Junction to Case		RθJC	120	

1.The device mounted on 1in<sup>2</sup> FR4 board with 2 oz copper

## 6. ELECTRICAL CHARACTERISTICS (Ta= 25°C)

Characteristic	Symbol	Min.	Typ.	Max.	Unit	
STATIC						
Drain-Source Breakdown Voltage (VGS = 0, ID = 250μA)	V(BR)DSS	60	-	-	V	
Gate Threshold Voltage (VDS = VGS, ID = 250μA)	VGS(th)	1.0	-	3.0	V	
Gate Body Leakage (VDS =0V, VGS =±20V)	IGSS	-	-	±100	nA	
Zero Gate Voltage Drain Current (VDS =60V, VGS =0V)	IDSS	-	-	1	μA	
Drain-Source On-Resistance (VGS =10V, ID = 2.6A) (VGS =4.5V, ID = 2.1A)	RDS(on)	-	82 96	100 130	mΩ	
Diode Forward Voltage (IS =1.0A, VGS =0V)	VSD	-	0.8	1.2	V	
DYNAMIC						
Total Gate Charge (VDS =30V, VGS =10V, ID =2.6A)	Qg	-	12	-	nC	
Total Gate Charge	(VDS =30V, VGS =4.5V, ID =2.6A)	Qg	-	6.5		-
Gate-Source Charge		Qgs	-	2.2		-
Gate-Drain Charge		Qgd	-	2.7		-
Input capacitance	(VDS =30V, VGS =0V, f=1MHz)	Ciss	-	350	-	pF
Output Capacitance		Coss	-	40	-	
Reverse Transfer Capacitance		Crss	-	12	-	
Gate Resistance (VDS =0V, VGS =0V, f=1MHz)	Rg	-	0.7	-	Ω	
Turn-On Delay Time	(VDD =20V, RL =20Ω, ID =1A, VGEN =10V, RG =1Ω)	td(on)	-	10	-	ns
Turn-On Rise Time		tr	-	11	-	
Turn-Off Delay Time		td(off)	-	29	-	
Turn-Off Fall Time		tf	-	3	-	

2.Pulse test; pulse width ≤300μs, duty cycle ≤2%.

**7.ELECTRICAL CHARACTERISTICS CURVES**

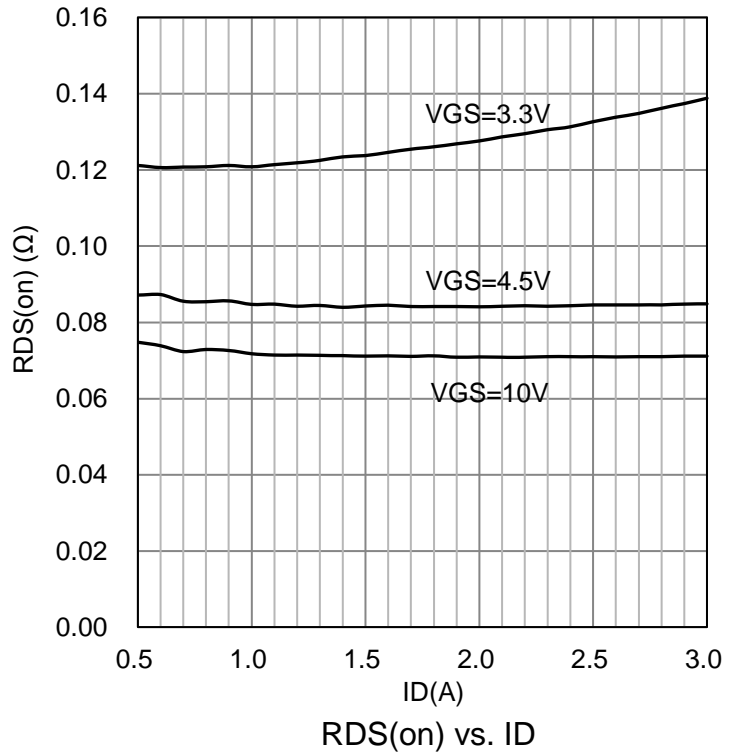
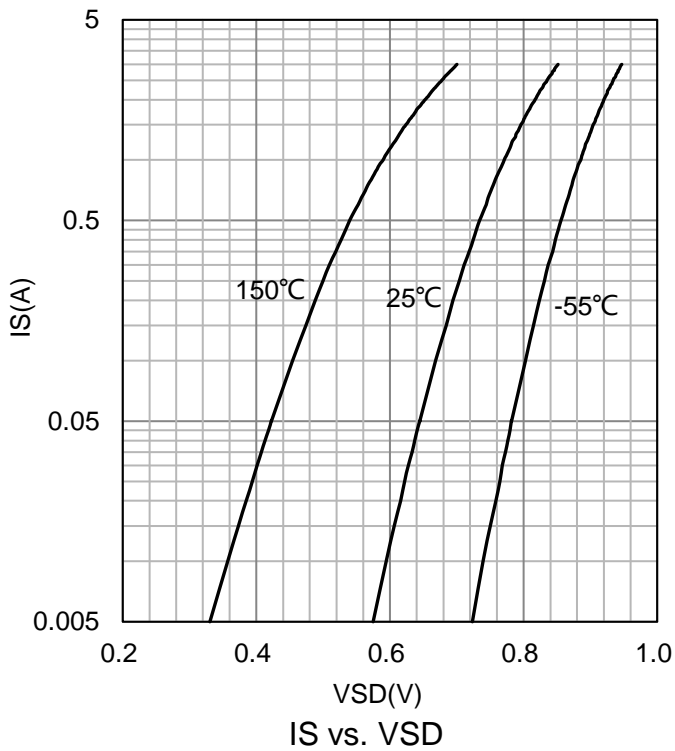
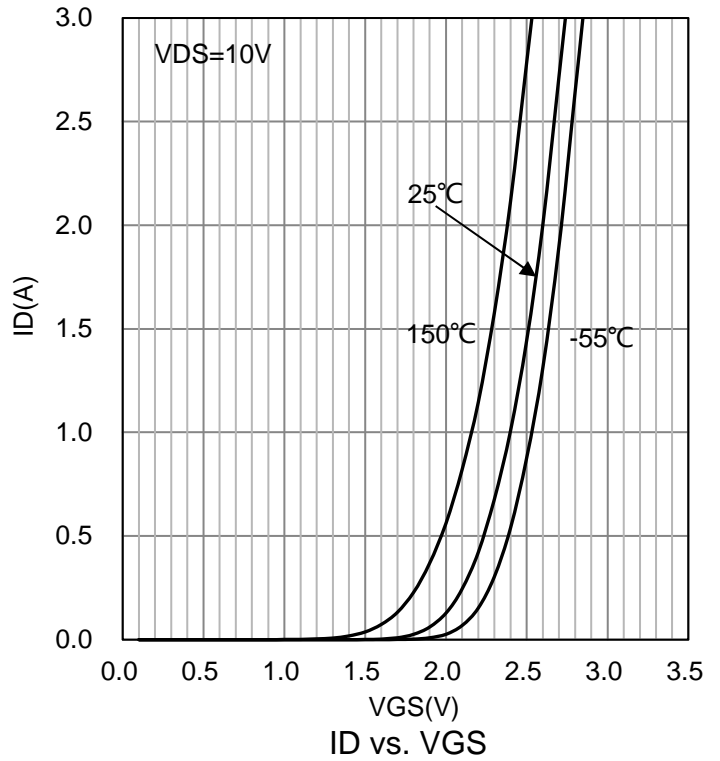
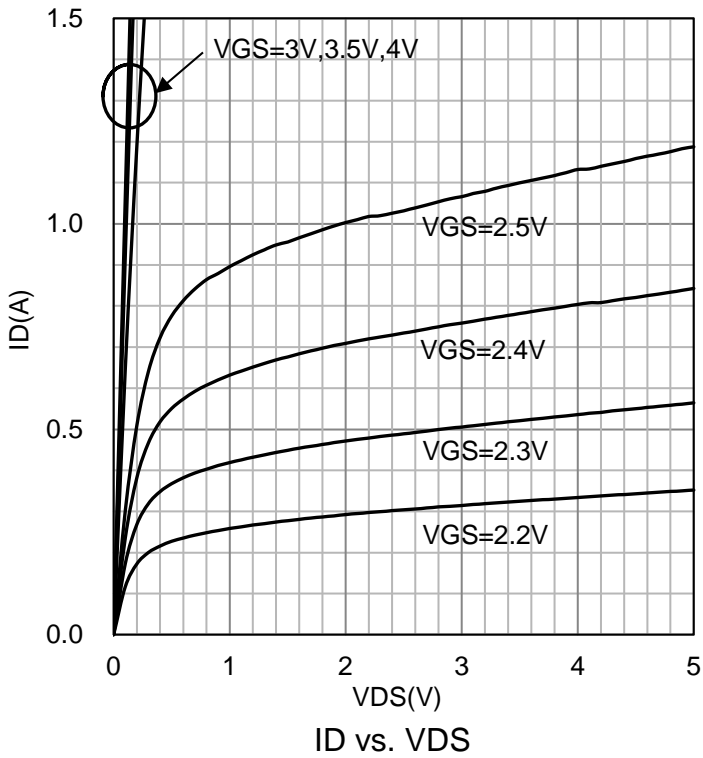

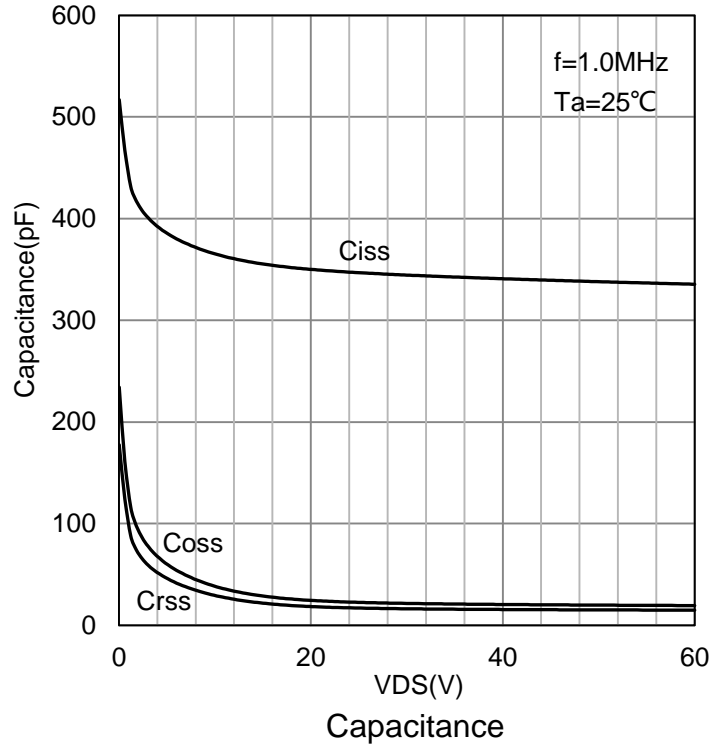
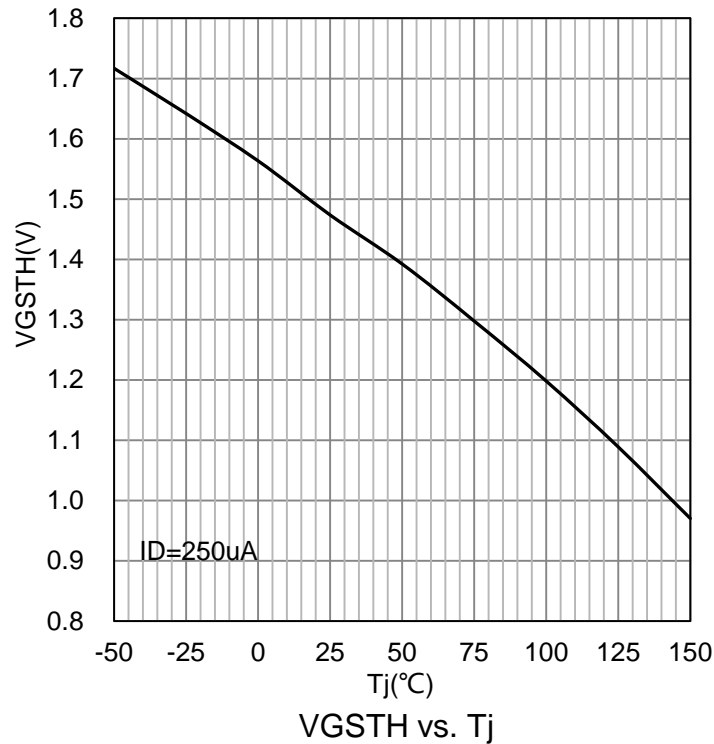
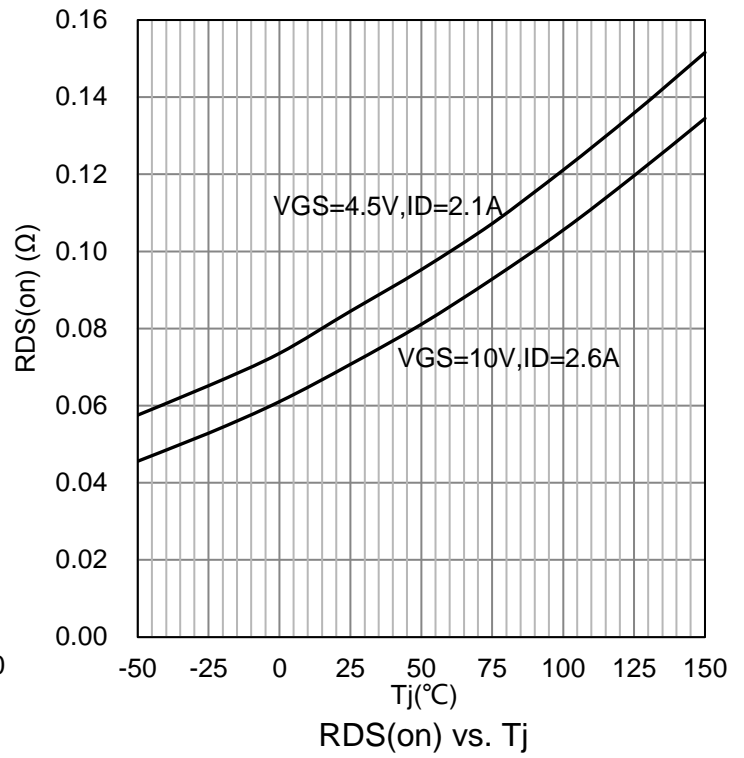
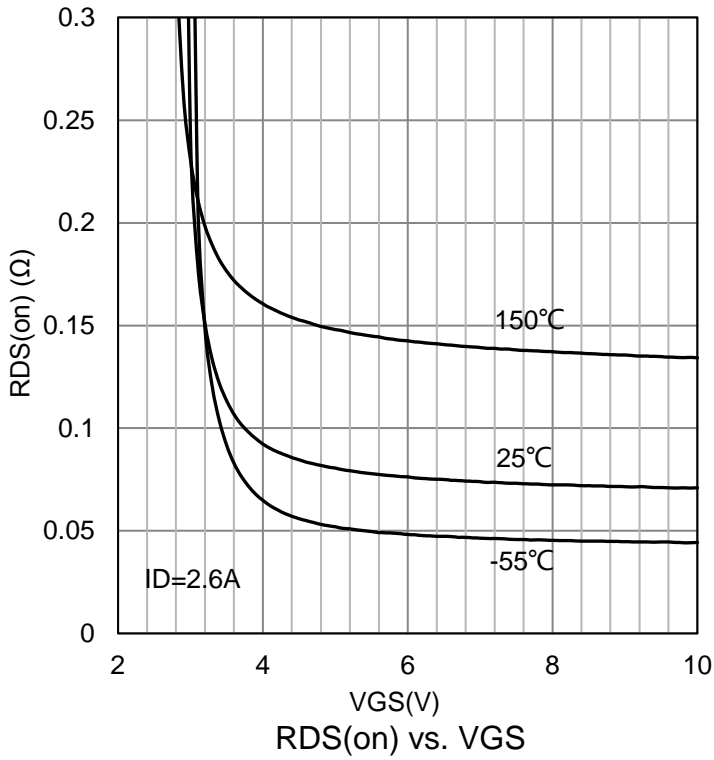
**7.ELECTRICAL CHARACTERISTICS CURVES (Con.)**

### 8.OUTLINE AND DIMENSIONS

Notes:

1. DIMENSIONING AND TOLERANCING PER ANSI Y14.5M, 1982.
2. CONTROLLING DIMENSION: MILLIMETERS.
3. MAXIMUM LEAD THICKNESS INCLUDES LEAD FINISH. MINIMUM LEAD THICKNESS IS THE MINIMUM THICKNESS OF BASE MATERIAL.
4. DIMENSIONS D AND E DO NOT INCLUDE MOLD FLASH, PROTRUSIONS OR GATE BURRS.

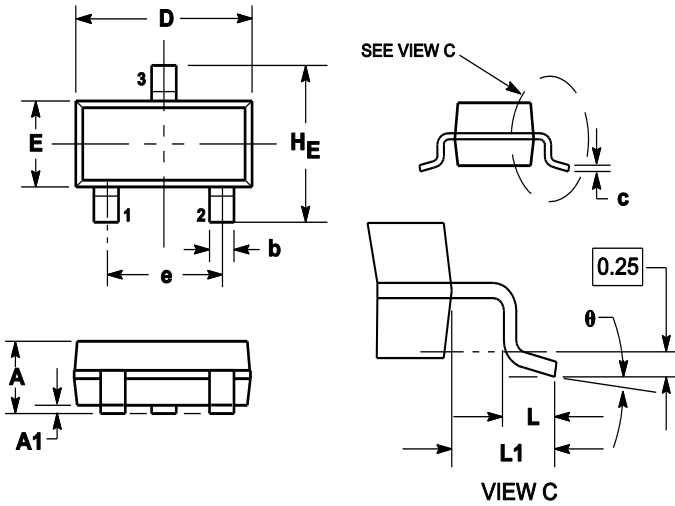

DIM	MILLIMETERS			INCHES		
	MIN	NOM	MAX	MIN	NOM	MAX
A	0.89	1	1.11	0.035	0.04	0.044
A1	0.01	0.06	0.1	0.001	0.002	0.004
b	0.37	0.44	0.5	0.015	0.018	0.02
c	0.09	0.13	0.18	0.003	0.005	0.007
D	2.80	2.9	3.04	0.11	0.114	0.12
E	1.20	1.3	1.4	0.047	0.051	0.055
e	1.78	1.9	2.04	0.07	0.075	0.081
L	0.10	0.2	0.3	0.004	0.008	0.012
L1	0.35	0.54	0.69	0.014	0.021	0.029
HE	2.10	2.4	2.64	0.083	0.094	0.104
θ	0°	---	10°	0°	---	10°

### 9.SOLDERING FOOTPRINT

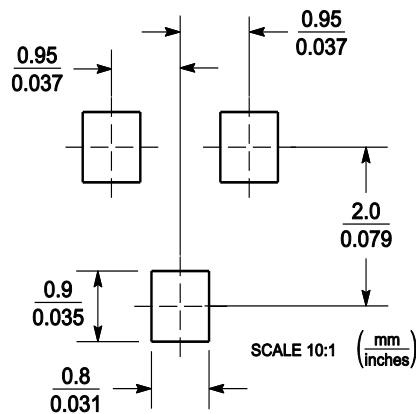

## **DISCLAIMER**

- Before you use our Products, you are requested to carefully read this document and fully understand its contents. LRC shall not be in any way responsible or liable for failure, malfunction or accident arising from the use of any LRC's Products against warning, caution or note contained in this document.
- All information contained in this document is current as of the issuing date and subject to change without any prior notice. Before purchasing or using LRC's Products, please confirm the latest information with a LRC sales representative.

## X-ON Electronics

Largest Supplier of Electrical and Electronic Components

*Click to view similar products for [MOSFET](#) category:*

*Click to view products by [Leshan](#) manufacturer:*

Other Similar products are found below :

[IRFD120](#) [JANTX2N5237](#) [2SK2267\(Q\)](#) [BUK455-60A/B](#) [TK100A10N1,S4X\(S](#) [MIC4420CM-TR](#) [VN1206L](#) [NDP4060](#) [SI4482DY](#)  
[IRS2092STRPBF-EL](#) [IPS70R2K0CEAKMA1](#) [TK31J60W5,S1VQ\(O](#) [TK31J60W,S1VQ\(O](#) [TK16J60W,S1VQ\(O](#) [2SK2614\(TE16L1,Q\)](#)  
[DMN1017UCP3-7](#) [EFC2J004NUZTDG](#) [P85W28HP2F-7071](#) [NTE2384](#) [DMC2700UDMQ-7](#) [DMN2080UCB4-7](#) [DMN61D9UWQ-13](#)  
[US6M2GTR](#) [DMN31D5UDJ-7](#) [DMP22D4UFO-7B](#) [IPS60R3K4CEAKMA1](#) [DMN1006UCA6-7](#) [DMN16M9UCA6-7](#) [STF5N65M6](#)  
[IRF40H233XTMA1](#) [STU5N65M6](#) [DMN6022SSD-13](#) [DMN13M9UCA6-7](#) [DMTH10H4M6SPS-13](#) [IPS60R360PFD7SAKMA1](#)  
[DMN2990UFB-7B](#) [SSM3K35CT,L3F](#) [IPLK60R1K0PFD7ATMA1](#) [2N7002W-G](#) [MCAC30N06Y-TP](#) [IPWS65R035CFD7AXKSA1](#)  
[MCQ7328-TP](#) [SSM3J143TU,LXHF](#) [DMN12M3UCA6-7](#) [PJMF280N65E1\\_T0\\_00201](#) [PJMF380N65E1\\_T0\\_00201](#)  
[PJMF280N60E1\\_T0\\_00201](#) [PJMF600N65E1\\_T0\\_00201](#) [PJMF900N65E1\\_T0\\_00201](#) [PJMF900N60E1\\_T0\\_00201](#)