

# LP2305ALT1G

## 20V P-Channel Enhancement-Mode MOSFET

### 1. FEATURES

- $V_{DS} = -20V$
- $R_{DS(ON)}, V_{GS@-4.5V}, I_{D@-3.5A} = 68m\Omega$
- $R_{DS(ON)}, V_{GS@-2.5V}, I_{D@-3A} = 81m\Omega$
- $R_{DS(ON)}, V_{GS@-1.8V}, I_{D@-2A} = 118m\Omega$
- Advanced trench process technology
- High Density Cell Design For Ultra Low On-Resistance
- Fully Characterized Avalanche Voltage and Current
- Improved Shoot-Through FOM
- We declare that the material of product compliance with RoHS requirements and Halogen Free.

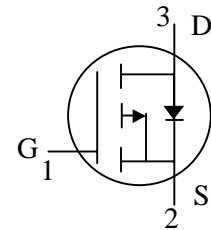
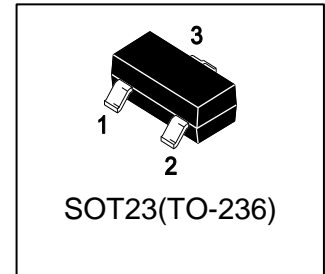

### 2. DEVICE MARKING AND ORDERING INFORMATION

Device	Marking	Shipping
LP2305ALT1G	P5A	3000/Tape&Reel
LP2305ALT3G	P5A	10000/Tape&Reel

### 3. MAXIMUM RATINGS( $T_a = 25^\circ C$ )

Parameter	Symbol	Limits	Unit
Drain–Source Voltage	$V_{DSS}$	-20	V
Gate–to–Source Voltage	$V_{GS}$	$\pm 8$	V
Continuous Drain Current	$I_D$	-4	A
Pulsed Drain Current(Note 1)	$I_{DM}$	-12	A
Power Dissipation(Note 2)	PD	1100	mW
Operating Junction and Storage Temperature Range	$T_J, T_{stg}$	-55~+150	$^\circ C$

1. Repetitive Rating: Pulse width limited by the maximum junction temperature

2.FR-5 = 1.0×0.75×0.062 in.

### 4. THERMAL CHARACTERISTICS

Parameter	Symbol	Limits	Unit
Thermal Resistance, Junction–to–Ambient	$R_{\theta JA}$	110	$^\circ C/W$

**5. ELECTRICAL CHARACTERISTICS (Ta= 25°C)**

Characteristic	Symbol	Min.	Typ.	Max.	Unit	
<b>Static</b>						
Drain–Source Breakdown Voltage (VGS = 0, ID = -250μA)	VBRDSS	-20	-	-	V	
Zero Gate Voltage Drain Current (VGS = 0, VDS = -6.4 V)	IDSS	-	-	-1	μA	
Gate–Body Leakage Current (VGS= ± 8V, VDS = 0V)	IGSS	-	-	±100	nA	
Forward Transconductance (VDS = -5V, ID = -3.5A)	gfs	-	8.5	-	S	
Gate Threshold Voltage (VDS = VGS, ID = -250μA)	VGS(th)	-0.45	-	-0.8	V	
Static Drain–Source On–State Resistance (VGS = -4.5 V, ID = -3.5 A) (VGS = -2.5 V, ID = -3 A) (VGS = -1.8 V, ID = -2 A)	RDS(on)	-	47 55 67	68 81 118	mΩ	
On-State Drain Current (VDS ≤ -5 V, VGS ≤ -4.5 V) (VDS ≤ -5 V, VGS ≤ -2.5 V)	ID(on)	-6 -3	- -	- -	A	
<b>Source-Drain Diode</b>						
Diode Forward Current	IS	-	-1.6	-	A	
Forward Voltage (IS = -1.6A, VGS = 0V)	VSD	-	-	-1.2	V	
<b>Dynamic</b>						
Total Gate Charge (VDS=-10V, VGS=-4.5V, ID=-3.0A)	Qg	-	5.76	-	nC	
Gate-Source Charge (VDS=-10V, VGS=-4.5V, ID=-3.0A)	Qgs	-	0.88	-		
Gate-Drain Charge (VDS=-10V, VGS=-4.5V, ID=-3.0A)	Qgd	-	2.2	-		
Input Capacitance (VGS = 0 V, f = 1.0MHz, VDS= -4 V)	Ciss	-	1245	-	pF	
Output Capacitance (VGS = 0 V, f = 1.0MHz, VDS= -4 V)	Coss	-	375	-	pF	
Reverse Transfer Capacitance (VGS = 0 V, f = 1.0MHz, VDS= -4 V)	Crss	-	210	-	pF	
<b>Switching</b>						
Turn-On Delay Time	(VDD = -4V, RL= 4Ω ID = -1A, VGEN = -4.5V RG = 6Ω)	td(on)	-	13	20	ns
Rise Time		tr	-	25	40	
Turn-Off Delay Time		td(off)	-	55	80	
Fall Time		tf	-	19	35	

3.Pulse Test: Pulse Width ≤300 μs, Duty Cycle ≤2.0%.

**6. ELECTRICAL CHARACTERISTICS CURVES**

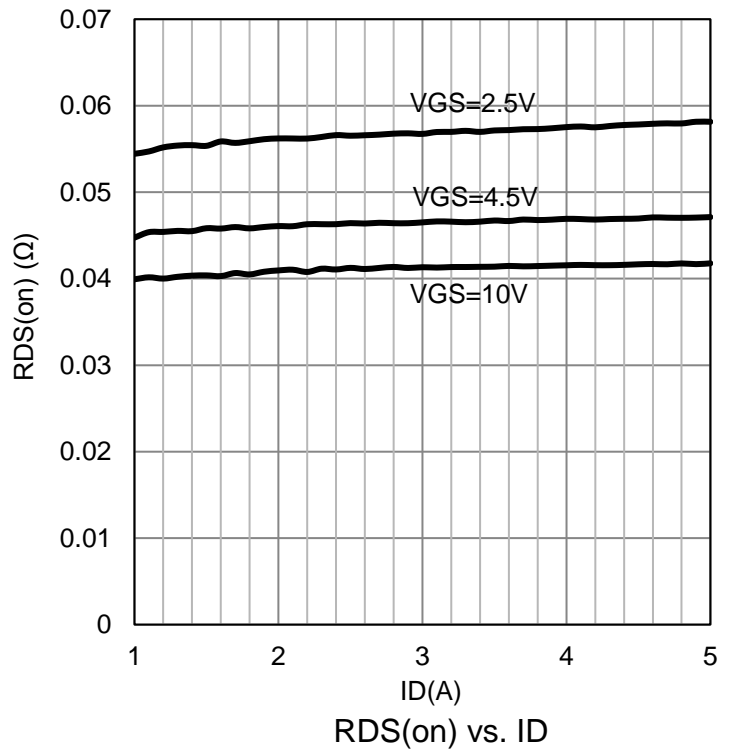
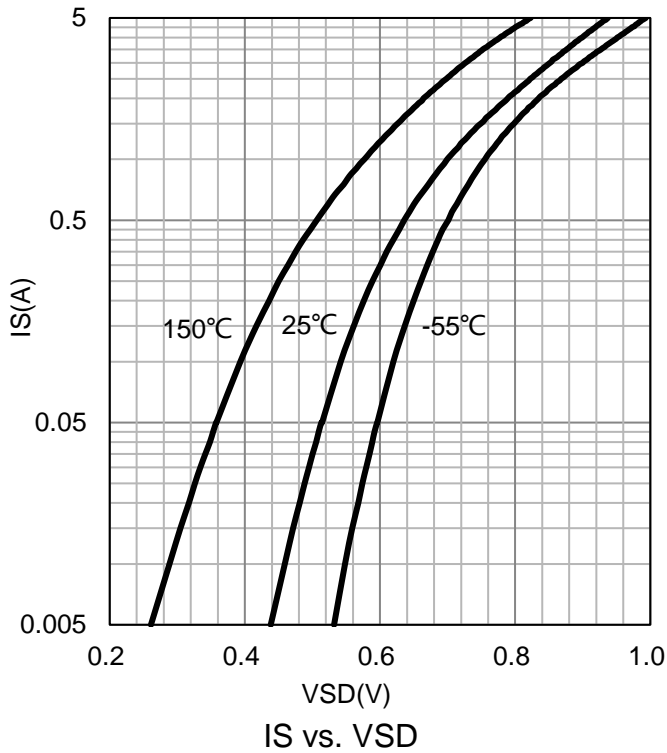
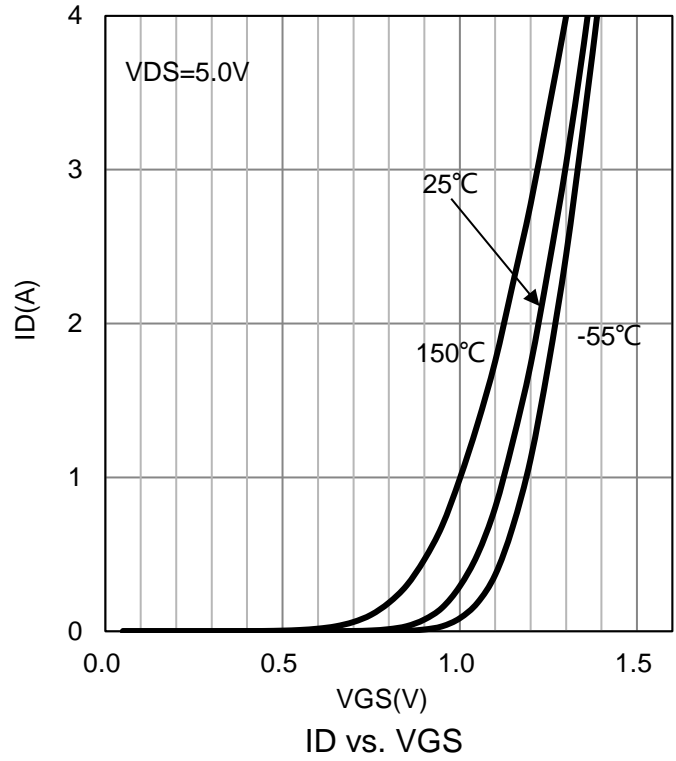
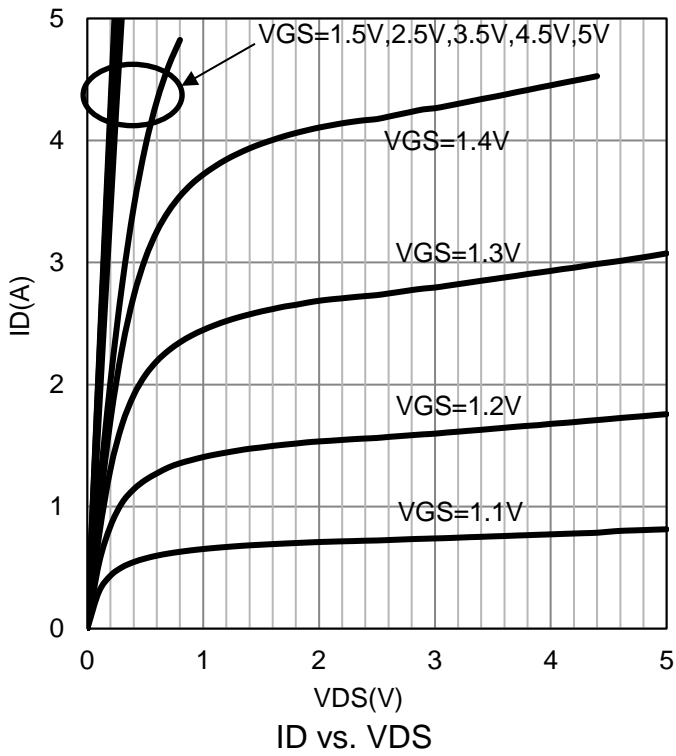

6.ELECTRICAL CHARACTERISTICS CURVES(Con.)

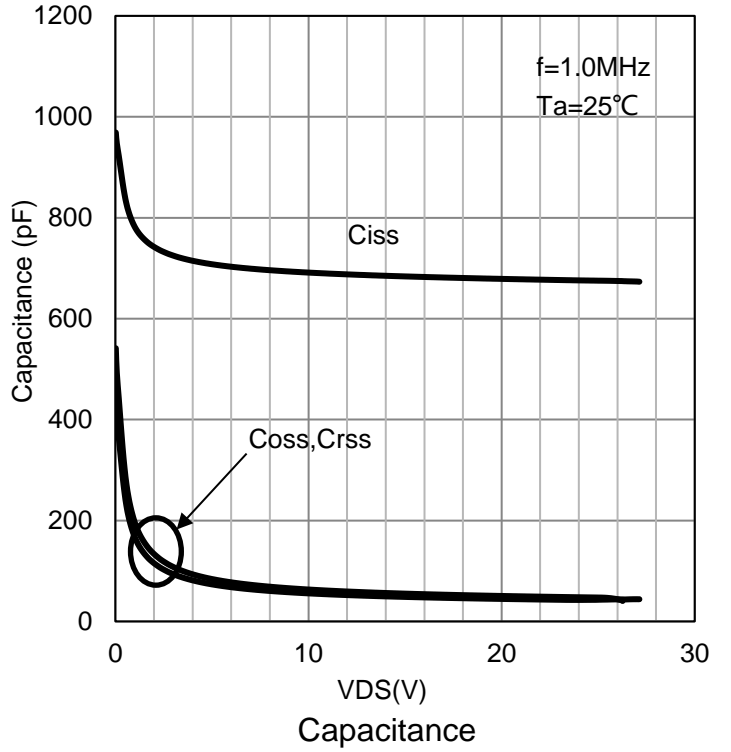
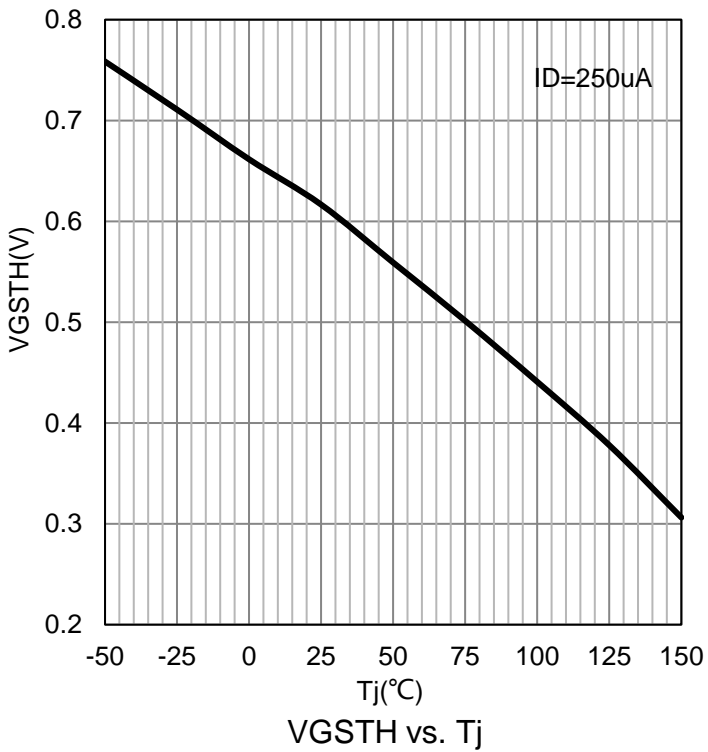
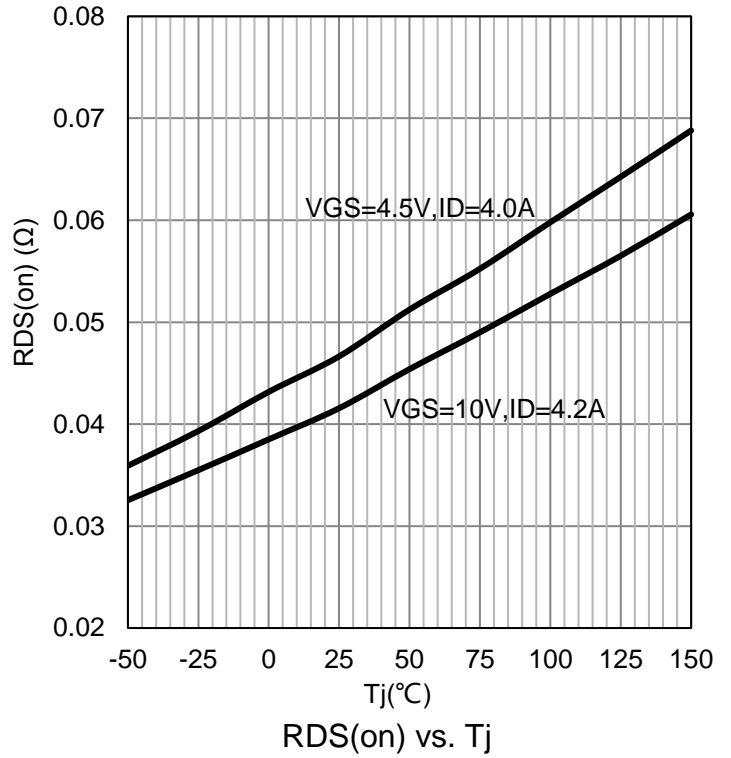
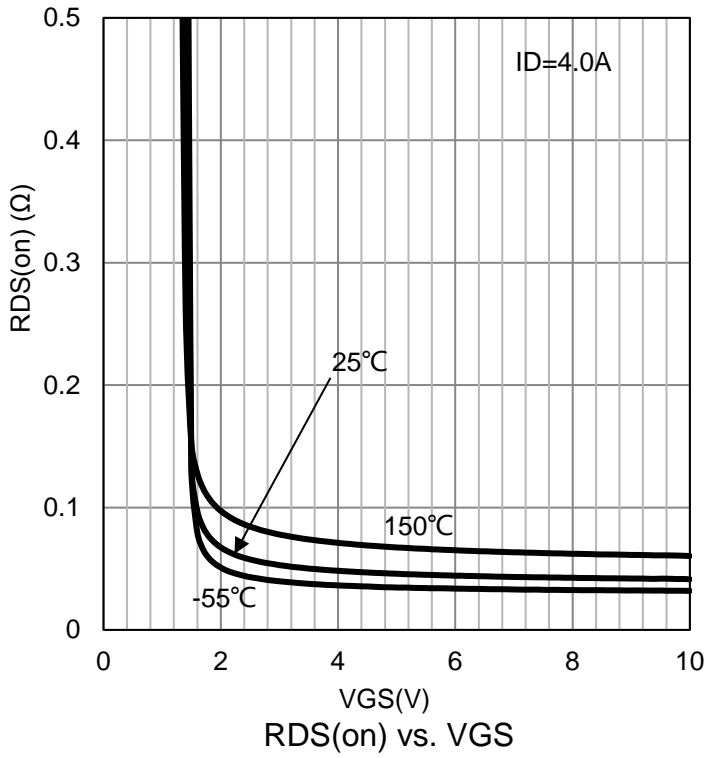

**7.OUTLINE AND DIMENSIONS**

Notes:

1. DIMENSIONING AND TOLERANCING PER ANSI Y14.5M, 1982.
2. CONTROLLING DIMENSION: MILLIMETERS.
3. MAXIMUM LEAD THICKNESS INCLUDES LEAD FINISH. MINIMUM LEAD THICKNESS IS THE MINIMUM THICKNESS OF BASE MATERIAL.
4. DIMENSIONS D AND E DO NOT INCLUDE MOLD FLASH, PROTRUSIONS OR GATE BURRS.

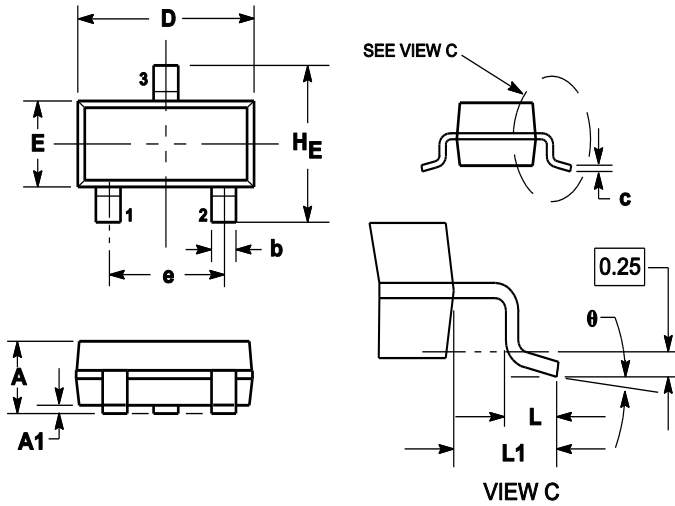

DIM	MILLIMETERS			INCHES		
	MIN	NOM	MAX	MIN	NOM	MAX
A	0.89	1	1.11	0.035	0.04	0.044
A1	0.01	0.06	0.1	0.001	0.002	0.004
b	0.37	0.44	0.5	0.015	0.018	0.02
c	0.09	0.13	0.18	0.003	0.005	0.007
D	2.80	2.9	3.04	0.11	0.114	0.12
E	1.20	1.3	1.4	0.047	0.051	0.055
e	1.78	1.9	2.04	0.07	0.075	0.081
L	0.10	0.2	0.3	0.004	0.008	0.012
L1	0.35	0.54	0.69	0.014	0.021	0.029
HE	2.10	2.4	2.64	0.083	0.094	0.104
θ	0°	---	10°	0°	---	10°

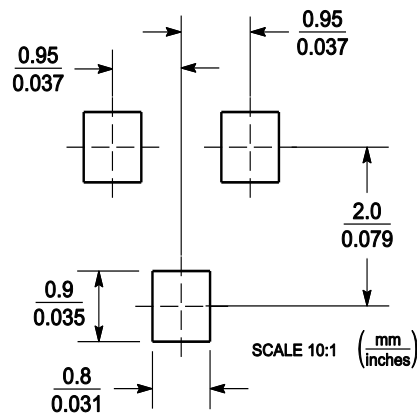
**8.SOLDERING FOOTPRINT**

## X-ON Electronics

Largest Supplier of Electrical and Electronic Components

*Click to view similar products for [MOSFET](#) category:*

*Click to view products by [Leshan](#) manufacturer:*

Other Similar products are found below :

[IRFD120](#) [JANTX2N5237](#) [2SK2267\(Q\)](#) [BUK455-60A/B](#) [TK100A10N1,S4X\(S](#) [MIC4420CM-TR](#) [VN1206L](#) [NDP4060](#) [SI4482DY](#)  
[IRS2092STRPBF-EL](#) [IPS70R2K0CEAKMA1](#) [SQM120N06-3M5L-GE3](#) [TK31J60W5,S1VQ\(O](#) [TK31J60W,S1VQ\(O](#) [TK16J60W,S1VQ\(O](#)  
[2SK2614\(TE16L1,Q\)](#) [DMN1017UCP3-7](#) [EFC2J004NUZTDG](#) [P85W28HP2F-7071](#) [NTE2384](#) [DMC2700UDMQ-7](#) [DMN2080UCB4-7](#)  
[DMN61D9UWQ-13](#) [US6M2GTR](#) [DMN31D5UDJ-7](#) [DMP22D4UFO-7B](#) [IPS60R3K4CEAKMA1](#) [DMN1006UCA6-7](#) [DMN16M9UCA6-7](#)  
[STF5N65M6](#) [IRF40H233XTMA1](#) [STU5N65M6](#) [DMN6022SSD-13](#) [DMN13M9UCA6-7](#) [DMTH10H4M6SPS-13](#) [IPS60R360PFD7SAKMA1](#)  
[DMN2990UFB-7B](#) [SSM3K35CT,L3F](#) [IPLK60R1K0PFD7ATMA1](#) [2N7002W-G](#) [MCAC30N06Y-TP](#) [IPWS65R035CFD7AXKSA1](#)  
[MCQ7328-TP](#) [SSM3J143TU,LXHF](#) [DMN12M3UCA6-7](#) [PJMF280N65E1\\_T0\\_00201](#) [PJMF380N65E1\\_T0\\_00201](#)  
[PJMF280N60E1\\_T0\\_00201](#) [PJMF600N65E1\\_T0\\_00201](#) [PJMF900N65E1\\_T0\\_00201](#)