

LP9435LT1G

S-LP9435LT1G

30V P-Channel Enhancement-Mode MOSFET

1. FEATURES

- $V_{DS} = -30V$
- $R_{DS(ON)}, V_{GS@-10V}, I_{DS@-5.3A} = 70m\Omega$
- $R_{DS(ON)}, V_{GS@-4.5V}, I_{DS@-4.2A} = 100m\Omega$
- We declare that the material of product compliance with RoHS requirements and Halogen Free.
- S- prefix for automotive and other applications requiring unique site and control change requirements; AEC-Q101 qualified and PPAP capable.

2. APPLICATIONS

- Advanced trench process technology
- High density cell design for ultra low on-resistance.

3. DEVICE MARKING AND ORDERING INFORMATION

Device	Marking	Shipping
LP9435LT1G	P94	3000/Tape&Reel
LP9435LT3G	P94	10000/Tape&Reel

4. MAXIMUM RATINGS($T_a = 25^\circ C$)

Parameter	Symbol	Limits	Unit
Drain–Source Voltage	V_{DSS}	-30	V
Gate–to–Source Voltage – Continuous	V_{GS}	± 20	V
Drain Current			A
– Continuous $T_A = 25^\circ C$	ID	-5.3	
– Pulsed (Note 1)	IDM	-20	

5. THERMAL CHARACTERISTICS

Parameter	Symbol	Limits	Unit
Power Dissipation	PD	1.4	W
Thermal Resistance, Junction–to–Ambient(Note 2)	$R_{\theta JA}$	90	$^\circ C/W$
Junction and Storage temperature	T_J, T_{stg}	$-55 \sim +150$	$^\circ C$

1.Repetitive Rating: Pulse width limited by the maximum junction temperature

2.1-in² 2oz Cu PCB board.

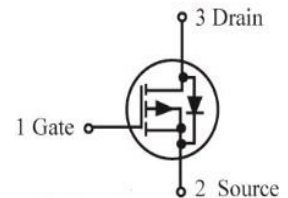
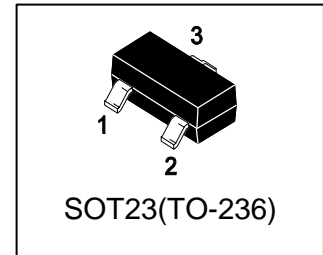

6. ELECTRICAL CHARACTERISTICS (Ta= 25°C)

Characteristic	Symbol	Min.	Typ.	Max.	Unit	
Static						
Drain–Source Breakdown Voltage (VGS = 0, ID = -250μA)	VBRDSS	-30	-	-	V	
Zero Gate Voltage Drain Current (VGS = 0, VDS = -24V)	IDSS	-	-	-1	μA	
Gate–Body Leakage Current, Forward (VGS = 20V)	IGSSF	-	-	100	nA	
Gate–Body Leakage Current, Reverse (VGS = - 20V)	IGSSR	-	-	-100	nA	
Gate Threshold Voltage (VDS = VGS, ID = -250μA)	VGS(th)	-1	-1.7	-3	V	
Static Drain–Source On–State Resistance(Note 3) (VGS = -10V, ID = -5.3A) (VGS = -4.5V, ID = -4.2A)	RDS(on)	-	50 70	70 100	mΩ	
Forward Voltage (VGS = 0V, ISD = -2.6A)	VSD	-	-	-1.3	V	
Dynamic						
Input Capacitance (VGS = 0V, f = 1.0MHz, VDS= -15V)	Ciss	-	644	-	pF	
Output Capacitance (VGS = 0V, f = 1.0MHz, VDS= -15V)	Coss	-	65	-	pF	
Reverse Transfer Capacitance (VGS = 0V, f = 1.0MHz, VDS= -15V)	Crss	-	51	-	pF	
Turn-On Delay Time	(VDD = -15V, RL = 15Ω ID = -1A, VGEN = -10V RG = 6.2Ω)	td(on)	-	3.6	-	ns
Rise Time		tr	-	4.2	-	
Turn-Off Delay Time		td(off)	-	22	-	
Fall Time		tf	-	6.3	-	
Total Gate Charge	(VDS = -15V, VGS = -10V, ID = -5.3A)	Qg	-	10	-	nC
Gate-Source Charge		Qgs	-	1.6	-	
Gate-Drain Charge		Qgd	-	1.8	-	

3.Pulse Test: Pulse Width ≤300 μs, Duty Cycle ≤2.0%.

7. ELECTRICAL CHARACTERISTICS CURVES

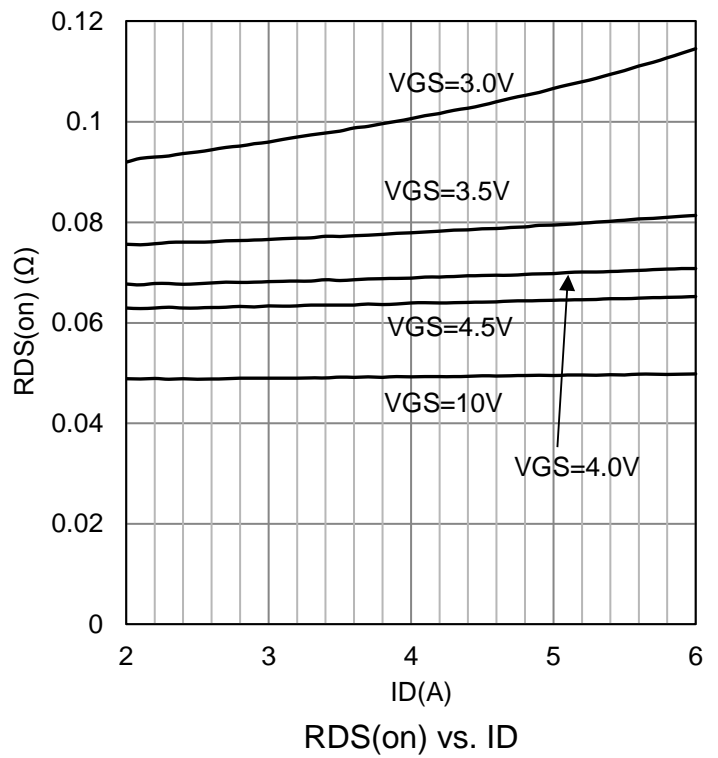
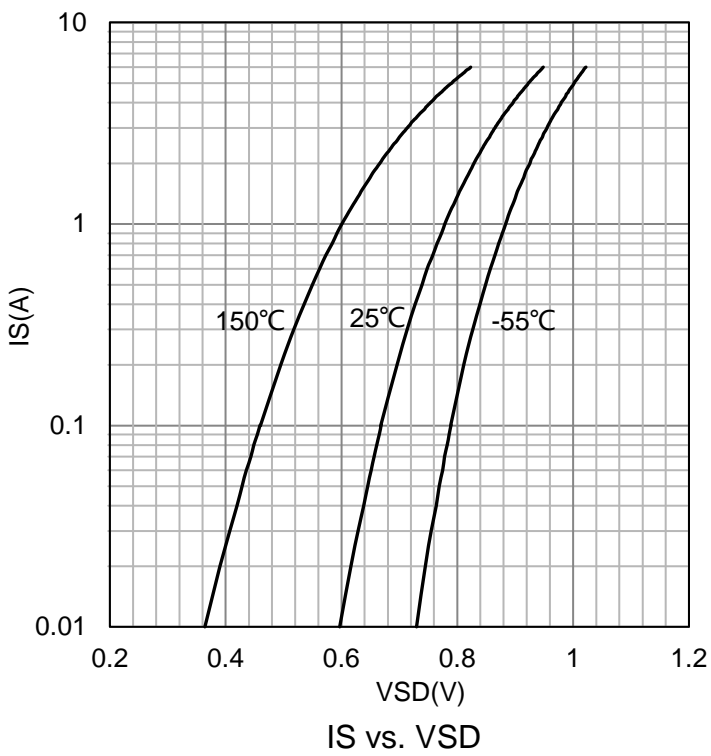
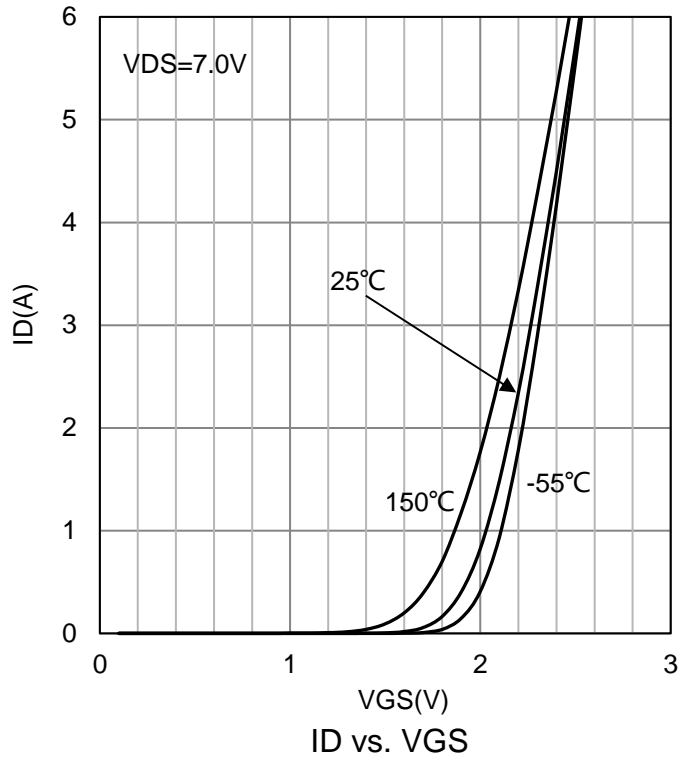
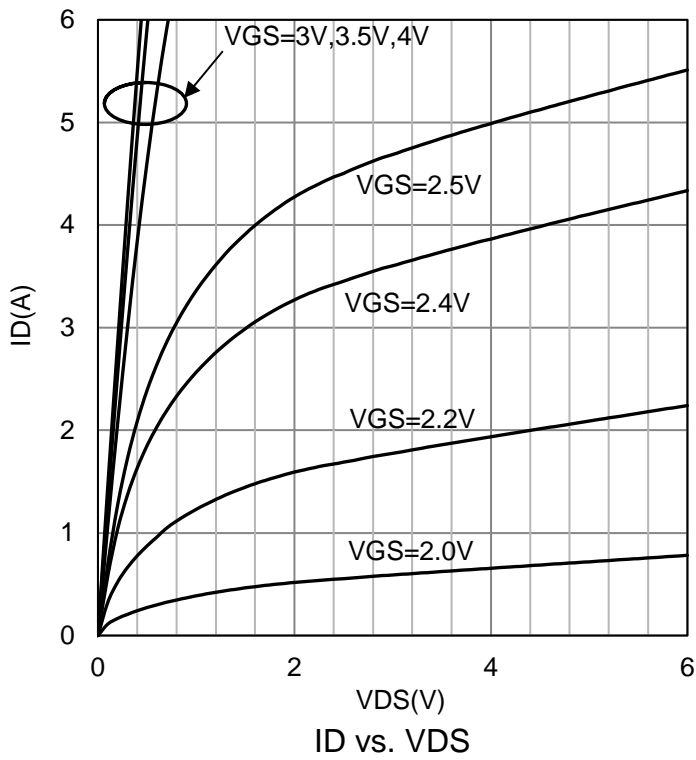

7. ELECTRICAL CHARACTERISTICS CURVES(Con.)

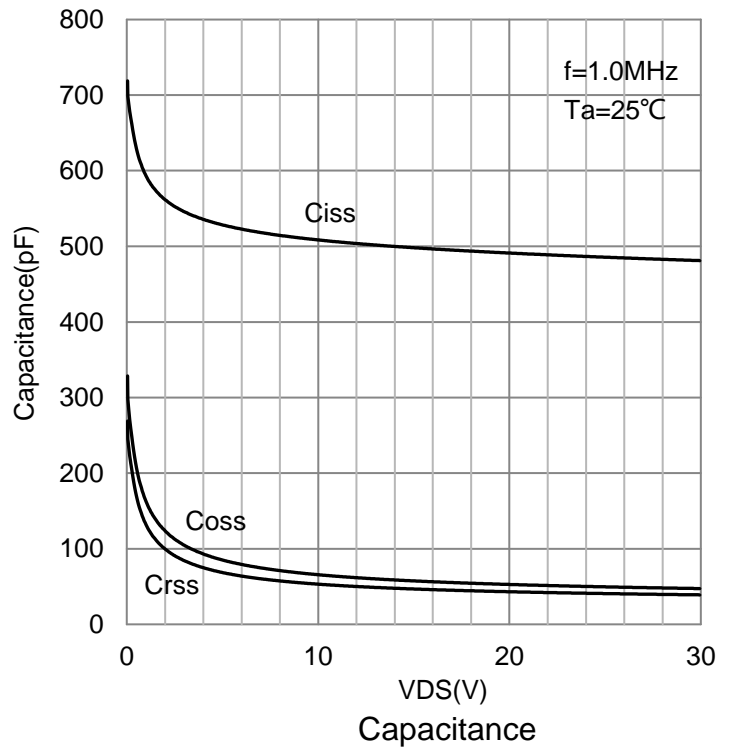
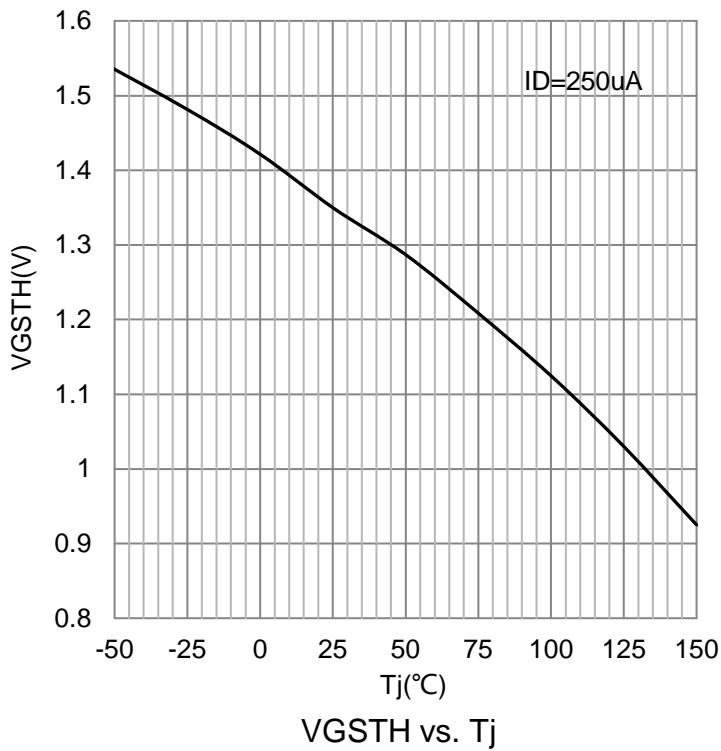
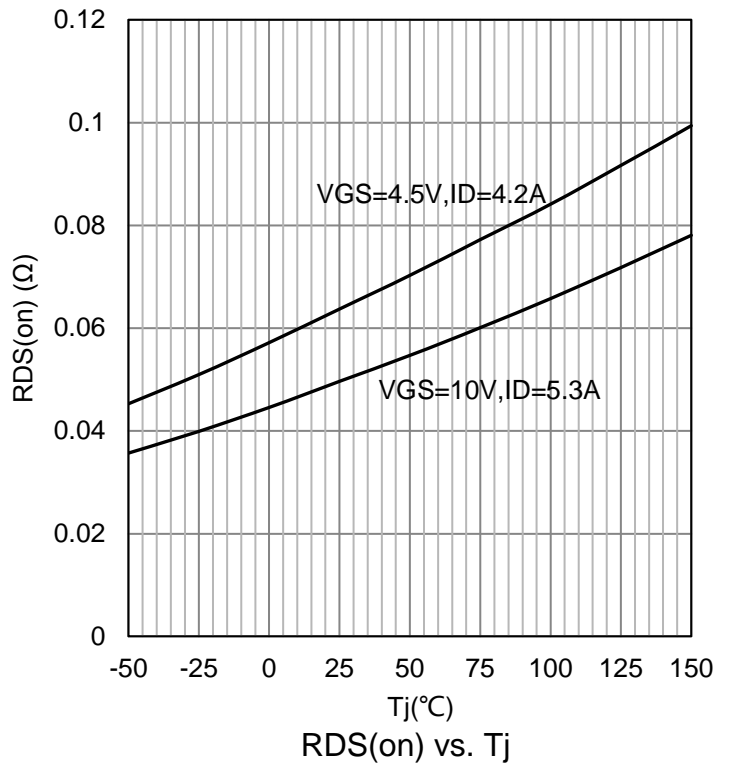
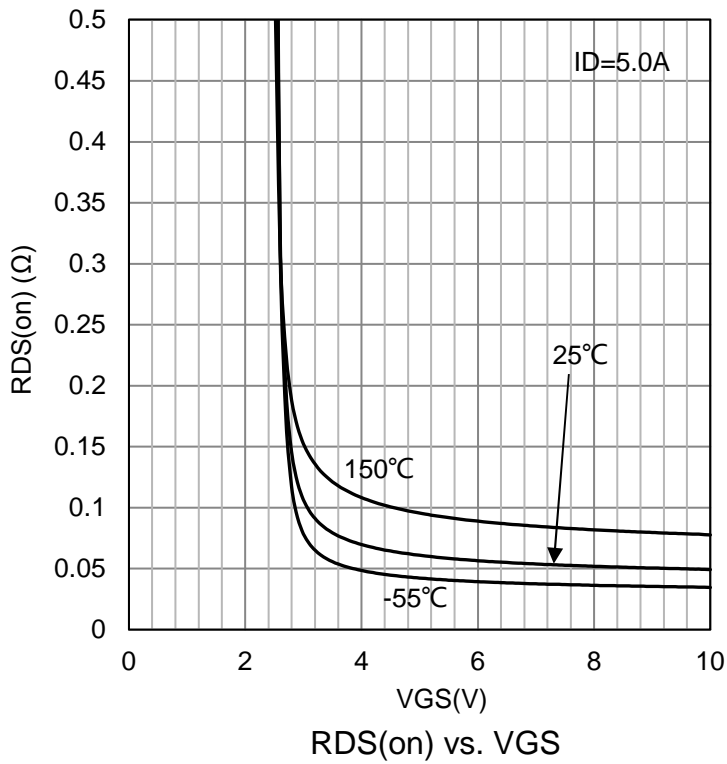

7. ELECTRICAL CHARACTERISTICS CURVES(Con.)

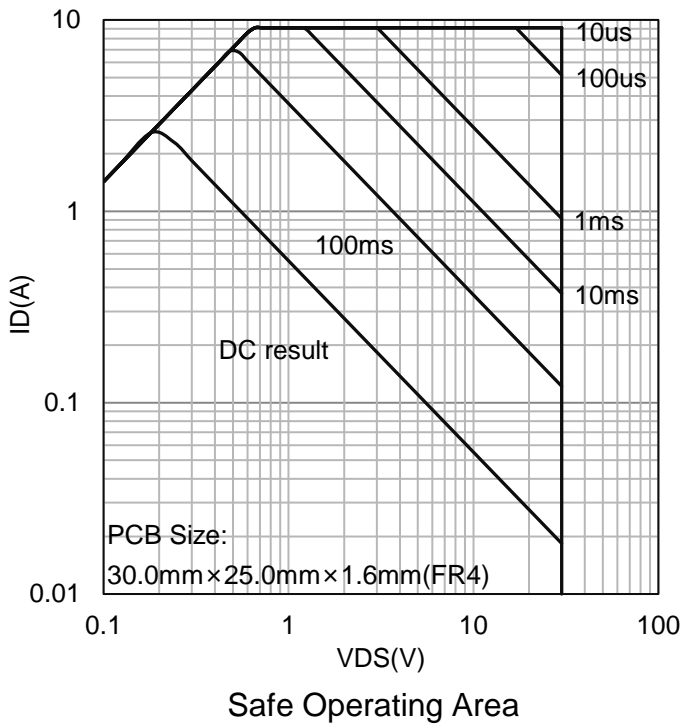

8.OUTLINE AND DIMENSIONS

Notes:

1. DIMENSIONING AND TOLERANCING PER ANSI Y14.5M, 1982.
2. CONTROLLING DIMENSION: MILLIMETERS.
3. MAXIMUM LEAD THICKNESS INCLUDES LEAD FINISH. MINIMUM LEAD THICKNESS IS THE MINIMUM THICKNESS OF BASE MATERIAL.
4. DIMENSIONS D AND E DO NOT INCLUDE MOLD FLASH, PROTRUSIONS OR GATE BURRS.

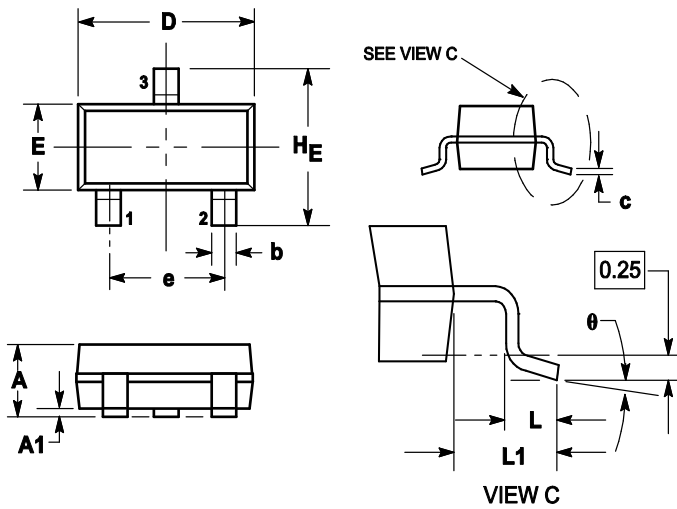

DIM	MILLIMETERS			INCHES		
	MIN	NOM	MAX	MIN	NOM	MAX
A	0.89	1	1.11	0.035	0.04	0.044
A1	0.01	0.06	0.1	0.001	0.002	0.004
b	0.37	0.44	0.5	0.015	0.018	0.02
c	0.09	0.13	0.18	0.003	0.005	0.007
D	2.80	2.9	3.04	0.11	0.114	0.12
E	1.20	1.3	1.4	0.047	0.051	0.055
e	1.78	1.9	2.04	0.07	0.075	0.081
L	0.10	0.2	0.3	0.004	0.008	0.012
L1	0.35	0.54	0.69	0.014	0.021	0.029
HE	2.10	2.4	2.64	0.083	0.094	0.104
θ	0°	---	10°	0°	---	10°

9.SOLDERING FOOTPRINT

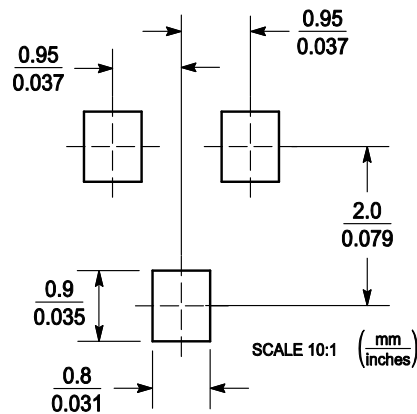

DISCLAIMER

- Before you use our Products, you are requested to carefully read this document and fully understand its contents. LRC shall not be in any way responsible or liable for failure, malfunction or accident arising from the use of any LRC's Products against warning, caution or note contained in this document.
- All information contained in this document is current as of the issuing date and subject to change without any prior notice. Before purchasing or using LRC's Products, please confirm the latest information with a LRC sales representative.

X-ON Electronics

Largest Supplier of Electrical and Electronic Components

Click to view similar products for [MOSFET](#) category:

Click to view products by [Leshan](#) manufacturer:

Other Similar products are found below :

[IRFD120](#) [IRFF430](#) [JANTX2N5237](#) [2SK2267\(Q\)](#) [BUK455-60A/B](#) [TK100A10N1,S4X\(S](#) [MIC4420CM-TR](#) [VN1206L](#) [NDP4060](#) [SI4482DY](#)
[IRS2092STRPBF-EL](#) [IPS70R2K0CEAKMA1](#) [SQM120N06-3M5L-GE3](#) [TK31J60W5,S1VQ\(O](#) [TK31J60W,S1VQ\(O](#) [TK16J60W,S1VQ\(O](#)
[2SK2614\(TE16L1,Q\)](#) [DMN1017UCP3-7](#) [EFC2J004NUZTDG](#) [P85W28HP2F-7071](#) [NTE2384](#) [DMC2700UDMQ-7](#) [DMN2080UCB4-7](#)
[DMN61D9UWQ-13](#) [US6M2GTR](#) [DMN31D5UDJ-7](#) [DMP22D4UFO-7B](#) [IPS60R3K4CEAKMA1](#) [DMN1006UCA6-7](#) [DMN16M9UCA6-7](#)
[STF5N65M6](#) [IRF40H233XTMA1](#) [STU5N65M6](#) [DMN6022SSD-13](#) [DMN13M9UCA6-7](#) [DMTH10H4M6SPS-13](#) [IPS60R360PFD7SAKMA1](#)
[DMN2990UFB-7B](#) [SSM3K35CT,L3F](#) [IPLK60R1K0PFD7ATMA1](#) [2N7002W-G](#) [MCAC30N06Y-TP](#) [IPWS65R035CFD7AXKSA1](#)
[MCQ7328-TP](#) [SSM3J143TU,LXHF](#) [DMN12M3UCA6-7](#) [PJMF280N65E1_T0_00201](#) [PJMF380N65E1_T0_00201](#)
[PJMF280N60E1_T0_00201](#) [PJMF600N65E1_T0_00201](#)