

4-CHANNEL LOW CAPACITANCE ESD PROTECTION DIODES ARRAY

The LRC1043-04DT1G is a 4-channel ultra low capacitance rail clam ESD protection diodes array . Each channel consists of a pair of diodes that steer positive or negative ESD current to either the positive or negative rail . A zener diode is integrated in to the array between the positive and negative supply rails. In the typical applications, the negative rail pin (assigned as GND) is connected with system ground . The Positive ESD current is steered to the ground through an ESD diode and Zener diode and the positive ESD voltage is clamped to the zener voltage.

The LRC1043-04DT1G is idea to protect high speed data lines.

LRC1043-04DT1G

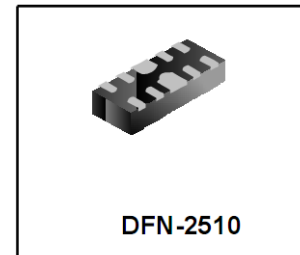

DFN-2510

● APPLICATIONS

- 1) HDMI / DVI ports
- 2) Display Port interface
- 3) 10M / 100M / 1G Ethernet
- 4) USB 2.0 interface
- 4) VGA interface
- 5) Set-top box
- 6) Flat panel Monitors / TVs
- 7) PC / Note book

● FEATURES

- 1) 4 channels of ESD protection;
- 2) Provides ESD protection to IEC61000-4-2 level 4
 - ±15kV air discharge
 - ±10kV contact discharge;
- 3) Channel I/O to GND capacitance: 0.65pF(Max)
- 4) Channel I/O to I/O capacitance: 0.6pF(Max)
- 5) Low clamping voltage;
- 6) Low operating voltage;
- 7) Improved zener structure;
- 8) Optimized package for easy high speed data lines PCB layout;
- 9) RoHS compliant and Halogen Free.

PIN CONFIGURATION

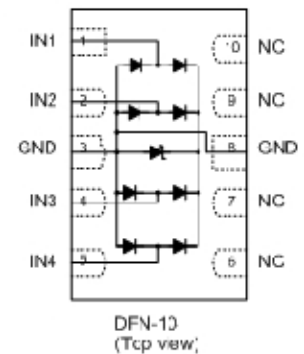

● DEVICE MARKING AND ORDERING INFORMATION

Device	Marking	Package	Shipping
LRC1043-04DT1G	59	DFN-2510	3000/Tape&Reel

● ABSOLUTE MAXIMUM RATINGS

Parameter	Symbol	Limits	Unit
Peak Pulse Power(8/20us)	PPP	70	W
Peak Pulse Current(8/20us)	IPP	5	A
ESD per IEC 61000-4-2(Air)	VESD1	±15kV	kV
ESD per IEC 61000-4-2(Contact)	VESD2	±10kV	kV
Operating Temperature Range	Topr	-55 ~ +125	℃
Storage Temperature Range	Tstg	-55 ~ +150	℃

● ELECTRICAL CHARACTERISTICS (Ta= 25℃)

Parameter	Symbol	Min.	Typ.	Max.	Unit	Conditions
Reverse Working Voltage	VRWM	–	–	3.3	V	Any I/O pin to GND
Reverse Breakdown Voltage	VBR	5.6	–	–	V	It =1mA; Any I/O pin to GND
Reverse Leakage Current	IR	–	–	1	μA	VRWM =3V, T=25℃; Any I/O pin to GND
Positive Clamping Voltage	VC1	–	8	13	V	IPP=5A, tP=8/20μs; Positive pulse; Any I/O pin to GND
Negative Clamping Voltage	VC2	–	1.8	–	V	IPP=1A, tP=8/20μs; Negative pulse; Any I/O pin to GND
Junction Capacitance Between Channel	CJ1	–	0.45	0.65	pF	VR=0V, f=1MHz; Between I/O pins
Junction Capacitance Between I/O And GND	CJ2	–	0.5	0.6	pF	VR=0V, f=1MHz; Any I/O pin to GND

ELECTRICAL CHARACTERISTIC CURVES

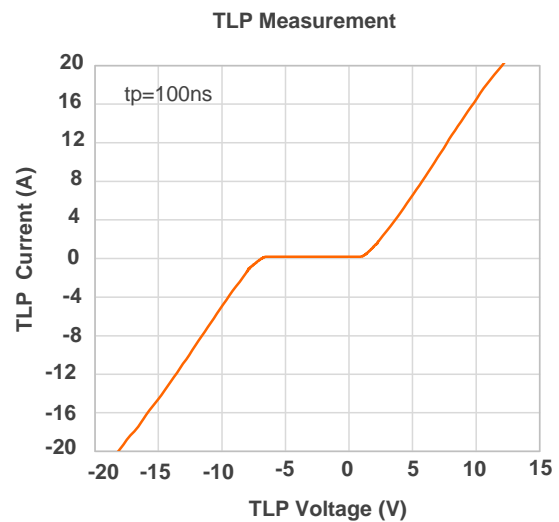
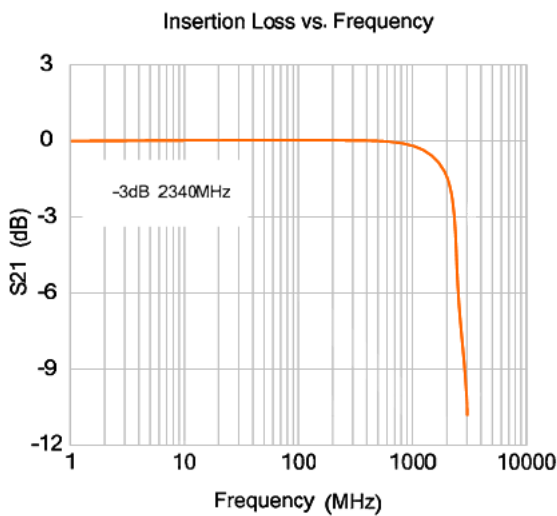
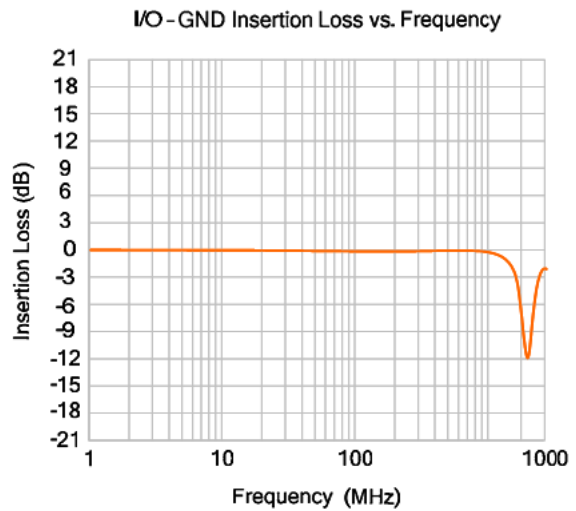
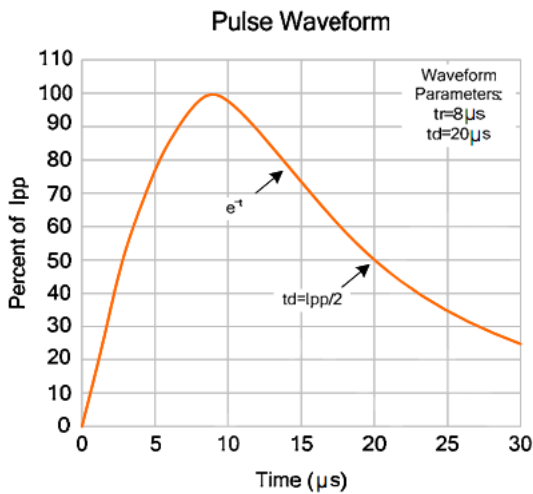
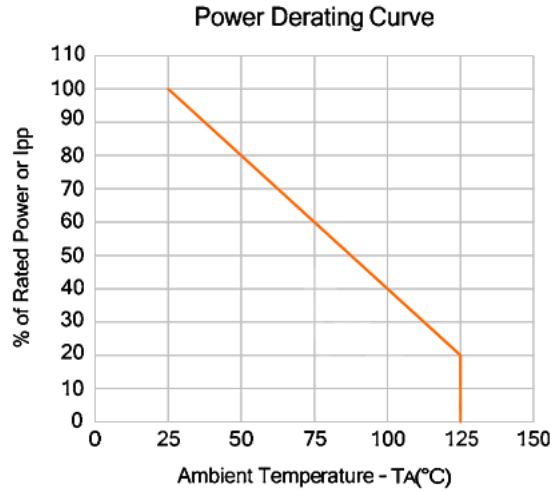
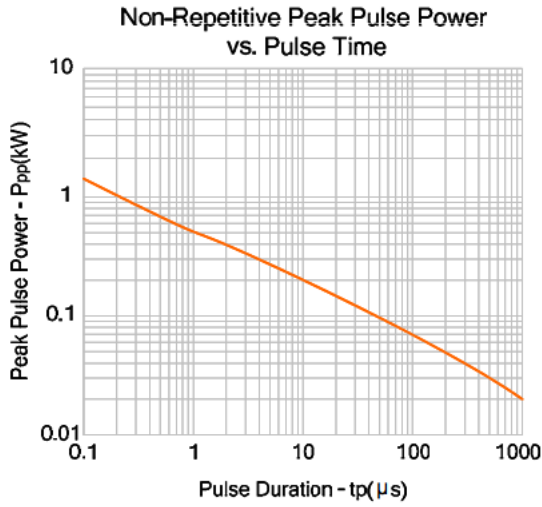

LRC1043-04DT1G

Package Outline Dimension

DFN2510

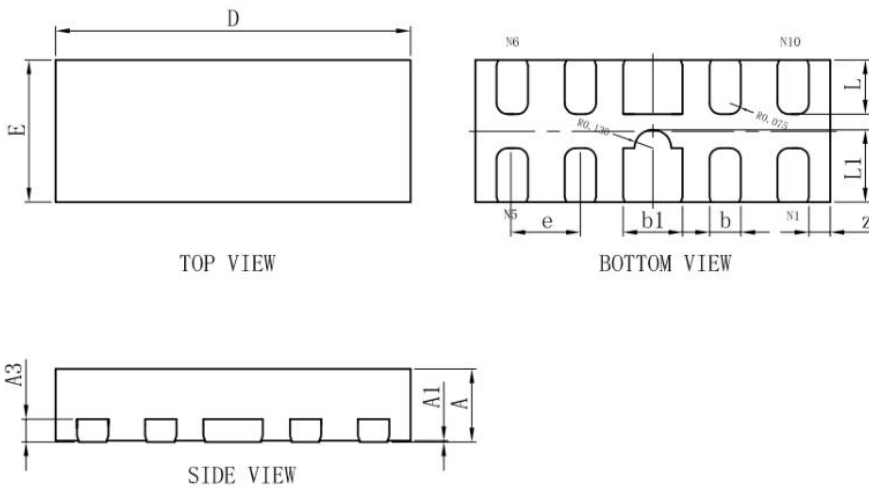

DFN2510			
Dim	Min	Typ	Max
A	0.48	0.53	0.58
A1	0	0.02	0.05
A3	-	0.152	-
b	0.17	0.22	0.27
b1	0.37	0.42	0.47
D	2.45	2.50	2.55
e	0.45	0.50	0.55
E	0.95	1.00	1.05
L	0.33	0.38	0.43
L1	0.46	0.51	0.56
z	0.10	0.15	0.20
All Dimensions in mm			

Suggested Pad layout

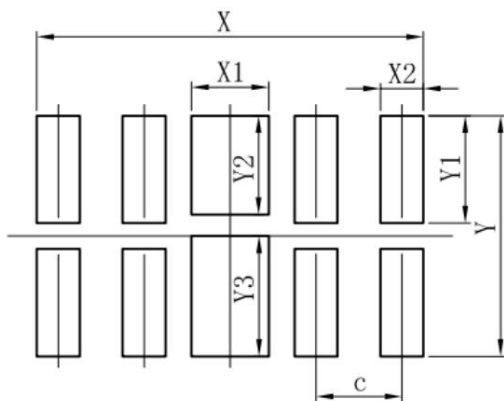

DFN2510	mm
c	0.5
X	2.25
X1	0.45
X2	0.25
Y	1.4
Y1	0.625
Y2	0.575
Y3	0.7

X-ON Electronics

Largest Supplier of Electrical and Electronic Components

Click to view similar products for [ESD Suppressors / TVS Diodes](#) category:

Click to view products by [Leshan](#) manufacturer:

Other Similar products are found below :

[60KS200C](#) [D18V0L1B2LP-7B](#) [D5V0F4U5P5-7](#) [NTE4902](#) [P4KE27CA](#) [P6KE11CA](#) [P6KE8.2A](#) [SA60CA](#) [SA64CA](#) [SMBJ12CATR](#)
[SMBJ33CATR](#) [SMBJ6.5A](#) [SMBJ8.0A](#) [ESD101-B1-02ELS](#) [E6327](#) [ESD112-B1-02EL](#) [E6327](#) [ESD7451N2T5G](#) [19180-510](#) [CPDT-5V0USP-](#)
[HF](#) [3.0SMCJ33CA-F](#) [3.0SMCJ36A-F](#) [HSPC16701B02TP](#) [JANTX1N6126A](#) [D3V3Q1B2DLP3-7](#) [D55V0M1B2WS-7](#) [SCM1293A-04SO](#)
[ESD200-B1-CSP0201](#) [E6327](#) [SM12-7](#) [CEN955](#) [W/DATA](#) [VESD12A1A-HD1-GS08](#) [CPDQC5V0-HF](#) [D1213A-01LP4-7B](#) [ESD101-B1-02EL](#)
[E6327](#) [AOZ8808DI-03](#) [5KP15A](#) [5KP48A](#) [5KP90A](#) [ESD3V3D7-TP](#) [15KPA36A-LF](#) [P4KE56CA](#) [P4KE68A](#) [P4KE91CATR](#) [P6KE120A](#)
[P6KE13CA](#) [P6KE43CA](#) [P6KE6.8CA](#) [P6KE8.2](#) [P6SMBJ20CA](#) [JANTX1N6072A](#) [SR2835ESKG](#) [SA90CA](#)