

S3MC

Surface Mount Glass Passivated Rectifiers
Reverse Voltage 1000V Forward Current 3.0A

1. FEATURES

- We declare that the material of product compliance with RoHS requirements and Halogen Free.
- Plastic package has Underwriters Laboratory Flammability Classification 94V-0.
- High temperature metallurgically bonded construction.
- Cavity-free glass passivated junction.
- Capable of meeting environmental standards of MIL-S-19500.
- For use in high frequency rectifier circuits.
- Fast Switching for high efficiency
- Typical IR less than 1.0 μ A.
- High temperature soldering guaranteed:260 $^{\circ}$ C/10 seconds.
- Weight: 0.26g



2. DEVICE MARKING AND ORDERING INFORMATION

Device	Marking	Shipping
S3MC	S3MC	3000/Tape&Reel

3. MAXIMUM RATINGS(Ta = 25 $^{\circ}$ C)

Parameter	Symbol	Limits	Unit
Maximum repetitive peak reverse voltage	VRRM	1000	V
Maximum RMS voltage	VRMS	700	V
Maximum DC blocking voltage	VDC	1000	V
Maximum average forward rectified current at TC = 75 $^{\circ}$ C	IF(AV)	3	A
Peak forward surge current 8.3ms single half sine-wave superimposed on rated load (JEDEC Method)	IFSM	100	A
Typical thermal resistance (Note 1)	R θ JA	80	$^{\circ}$ C/W
	R θ JC	20	
Operating junction and storage temperature range	TJ, TSTG	-50 ~+150	$^{\circ}$ C

4. ELECTRICAL CHARACTERISTICS (Ta= 25 $^{\circ}$ C)

Characteristic	Symbol	Min.	Typ.	Max.	Unit
Maximum instantaneous forward voltage at 3.0A	VF	-	-	1.1	V
Maximum DC reverse current TA = 25 $^{\circ}$ C at rated DC blocking voltage TJ = 125 $^{\circ}$ C	IR	-	-	5	μ A
		-	-	100	
Typical junction capacitance at 4.0V, 1MHz	CJ	-	15	-	PF

1. Mounted on 0.31 x 0.31" (8.0 x 8.0mm) copper pads to each terminal

5. ELECTRICAL CHARACTERISTICS CURVES

Fig. 1 - Forward Current Derating Curve

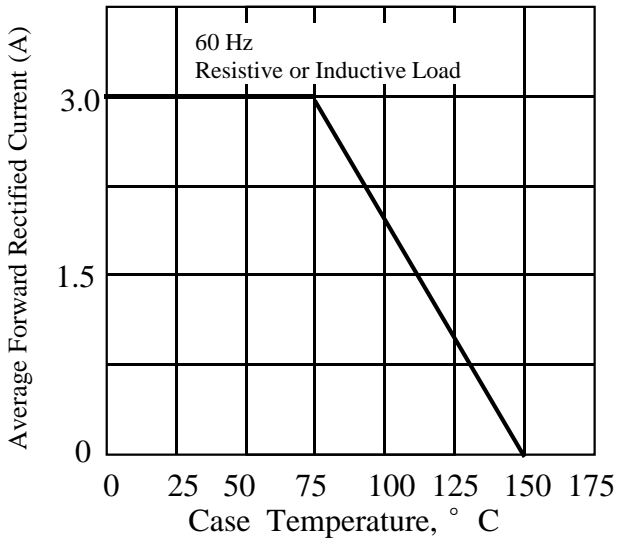

Fig. 3. - Typical Instantaneous Forward Characteristics

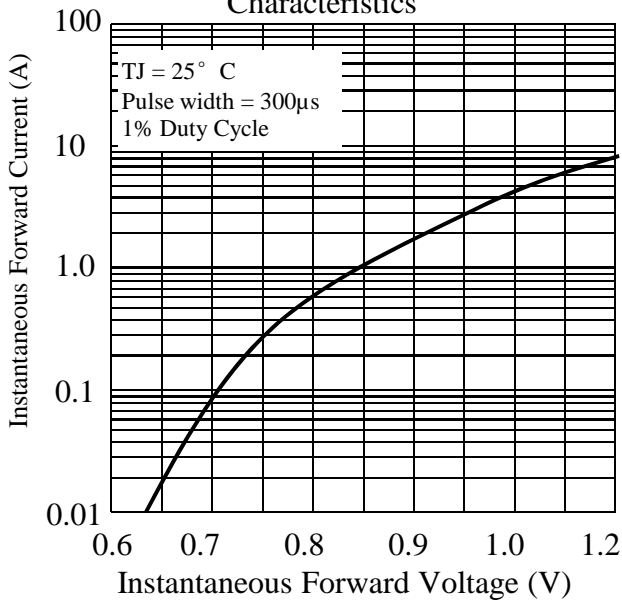

Fig. 5. - Typical Junction Capacitance

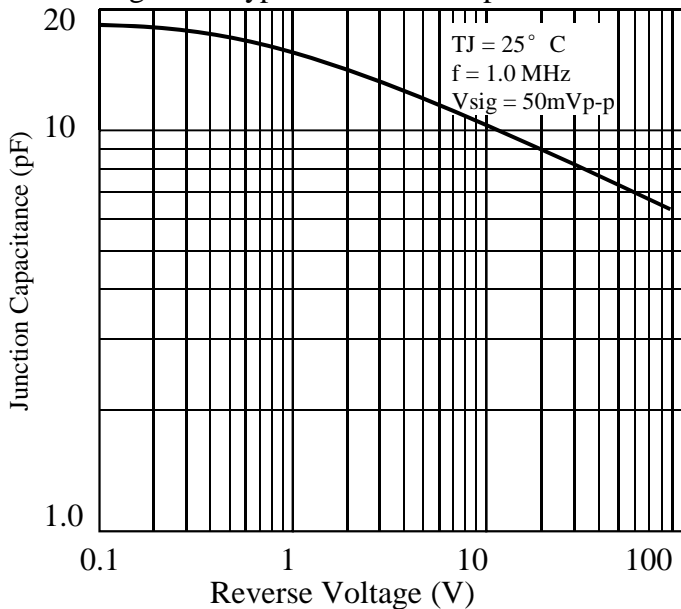

Fig. 2 - Maximum Non-repetitive Peak Forward Surge Current

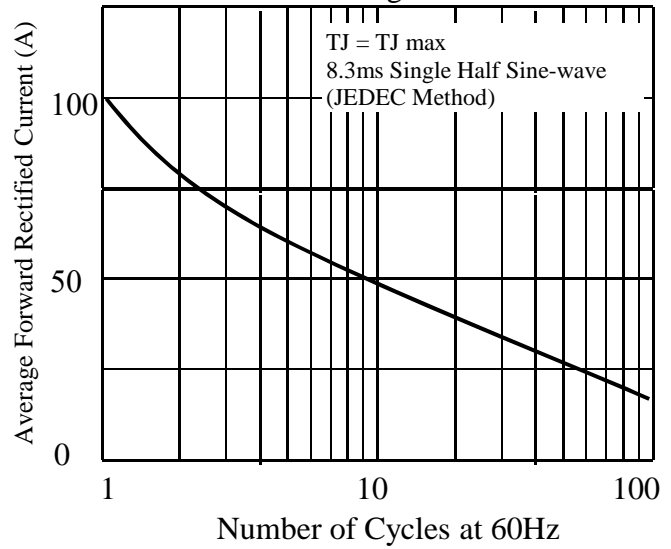
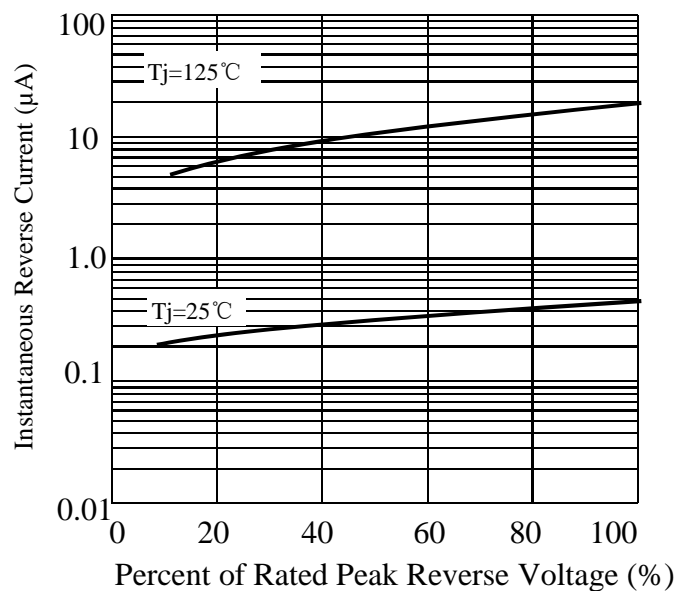
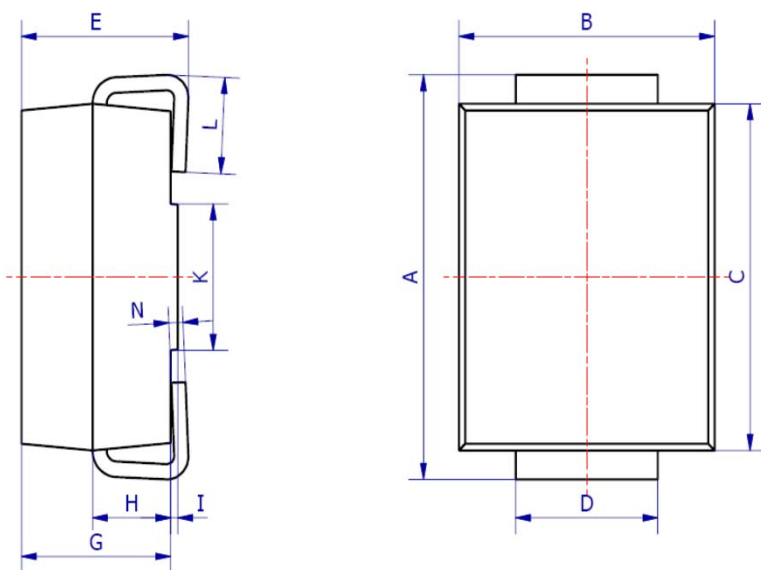

Fig. 4. - Typical Reverse Characteristics



6. OUTLINE AND DIMENSIONS



SMC			
DIM	Min	Max	Typ.
A	7.70	8.30	8.00
B	5.85	6.25	6.05
C	6.65	7.05	6.85
D	2.80	3.20	3.00
E	2.45	2.85	2.65
G	2.10	2.50	2.30
H	1.00	1.40	1.20
I	0.05	0.15	0.10
K	4.30	4.70	4.50
L	1.00	1.50	1.25
N	0.10	0.30	0.20
All Dimensions in mm			

7. SOLDERING FOOTPRINT

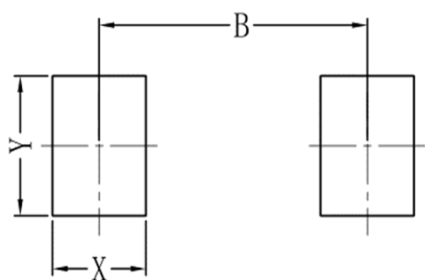

SMC	
DIM	(mm)
X	1.60
Y	3.30
B	6.60

X-ON Electronics

Largest Supplier of Electrical and Electronic Components

Click to view similar products for [Diodes - General Purpose, Power, Switching category:](#)

Click to view products by [Leshan manufacturer:](#)

Other Similar products are found below :

[MCL4151-TR3](#) [MMBD3004S-13-F](#) [RD0306T-H](#) [1N3611](#) [NTE156A](#) [NTE574](#) [NTE6244](#) [1SS193,LF](#) [1SS400CST2RA](#) [SDAA13](#)
[SHN2D02FUTW1T1G](#) [LS4151GS08](#) [1N4449](#) [1N456A](#) [1N4934-E3/73](#) [1N914BTR](#) [RFUH20TB3S](#) [D291S45T](#) [BAV300-TR](#) [BAW56DWQ-](#)
[7-F](#) [BAW56M3T5G](#) [BAW75-TAP](#) [MM230L-CAA](#) [IDW40E65D1](#) [JAN1N3600](#) [JAN1N4454UR-1](#) [LL4151-GS18](#) [SMMSD4148T3G](#)
[BYW95B/A52A](#) [NSVDAN222T1G](#) [CDSZC01100-HF](#) [LL4150-M-08](#) [1N4454-TR](#) [BAV70HDW-7](#) [BAS28-7](#) [JANTX1N6640](#) [BAW56HDW-](#)
[13](#) [BAS28 TR](#) [VS-HFA04SD60STR-M3](#) [NSVM1MA152WKT1G](#) [1SS388-TP](#) [RGP30D-E3/73](#) [VS-8EWF02S-M3](#) [BAV99TQ-13-F](#)
[BAV99HDW-13](#) [MMDB30-E28X](#) [IDP20C65D2XKSA1](#) [LS4148](#) [IDV15E65D2](#) [NSVM1MA152WAT1G](#)