

LBTN180Z4TZHG

S-LBTN180Z4TZHG

80V NPN medium power transistors

1. FEATURES

- High current
- Three current gain selections
- High power dissipation capability
- We declare that the material of product compliance with RoHS requirements and Halogen Free.
- S- prefix for automotive and other applications requiring unique site and control change requirements; AEC-Q101 qualified and PPAP capable.

2. DEVICE MARKING AND ORDERING INFORMATION

Device	Marking	Shipping
LBTN180Z4TZHG	NA	1000/Tape&Reel

3. MAXIMUM RATINGS(Ta = 25°C)

Parameter	Symbol	Limits	Unit
Collector–Emitter Voltage	VCEO	80	V
Collector–Base Voltage	VCBO	100	V
Emitter–Base Voltage	VEBO	5	V
Collector Current	IC	1	A
Peak Collector Current (tp≤1 ms)	ICM	2	A
Base Current	IB	0.3	A
Peak Base Current (tp≤1 ms)	IBM	0.3	A
Junction and Storage temperature	TJ, Tstg	-55~+150	°C

4. THERMAL CHARACTERISTICS

Parameter	Symbol	Limits	Unit
Total Device Dissipation, FR-4 Board (Note 1) @ TA = 25°C	PD	833	mW
Thermal Resistance, Junction–to–Ambient(Note 1)	RθJA	150	°C/W

1. FR-4 = 30.0mm×25.0mm×1.6mm.

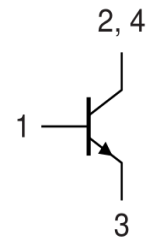
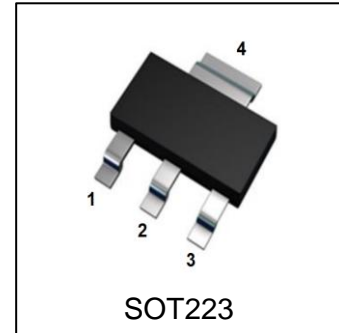

5. ELECTRICAL CHARACTERISTICS (Ta= 25°C)

Characteristic	Symbol	Min.	Typ.	Max.	Unit
Collector–Emitter Breakdown Voltage (IC = 1.0 mA, IB = 0)	VBR(CEO)	80	-	-	V
Collector–Base Breakdown Voltage (IC = 100 μA, IE = 0)	VBR(CBO)	100	-	-	V
Emitter–Base Breakdown Voltage (IE = 100 μA, IC = 0)	VBR(EBO)	5	-	-	V
Collector-Base Cutoff Current (VCB = 30 V, IE = 0 A) (VCB = 30 V, IE = 0 A, Tj = 150°C)	ICBO	-	-	100 10	nA μA
Emitter-Base CutOff Current (VEB = 5 V, IC = 0 A)	IEBO	-	-	100	nA
Collector-Emitter cutoff Current (VCE= 80V, IB=0)	ICEO	-	-	10	μA
DC Current Gain (IC = 5mA, VCE =2V) (IC =150mA, VCE =2V) (IC =500mA, VCE = 2V)	HFE	63 100 40	- - -	- 250 -	
Collector–Emitter Saturation Voltage (IC = 500 mA, IB = 50 mA)	VCE(sat)	-	-	0.5	V
Base–Emitter Saturation Voltage (IC = 500 mA, IB = 50 mA)	VBE(sat)	-	-	1	V
Base–Emitter Voltage (VCE = 2 V, IC = 500 mA)	VBE	-	-	1	V
Transitional Frequency (VCE = 5 V, IC = 50 mA, f = 100 MHz)	fT	100	180	-	MHz
Collector Capacitance (VCB = 10 V, IE = ie = 0 A, f = 1 MHz)	Cc	-	6	-	pF

1. Pulse Test: Pulse Width ≤300 μs, Duty Cycle ≤2.0%.

6.ELECTRICAL CHARACTERISTICS CURVES

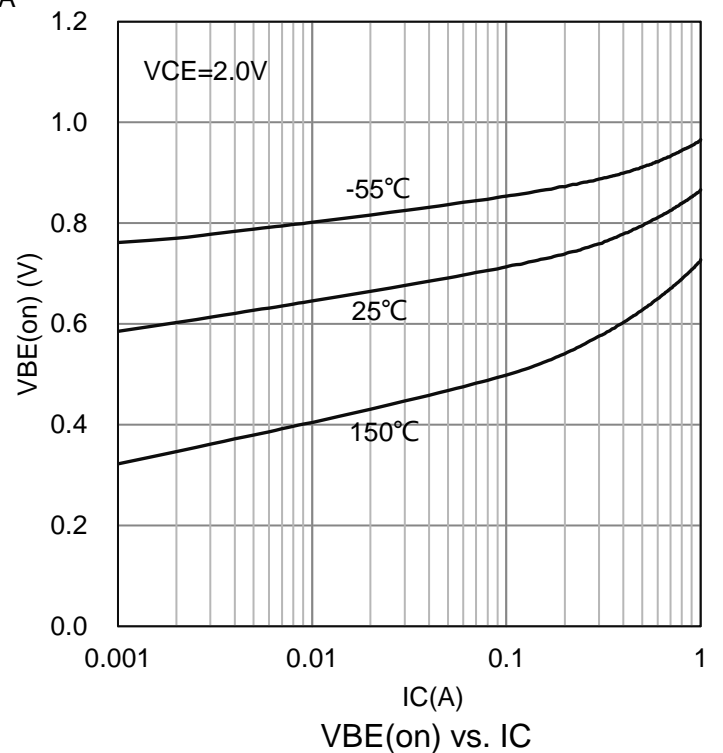
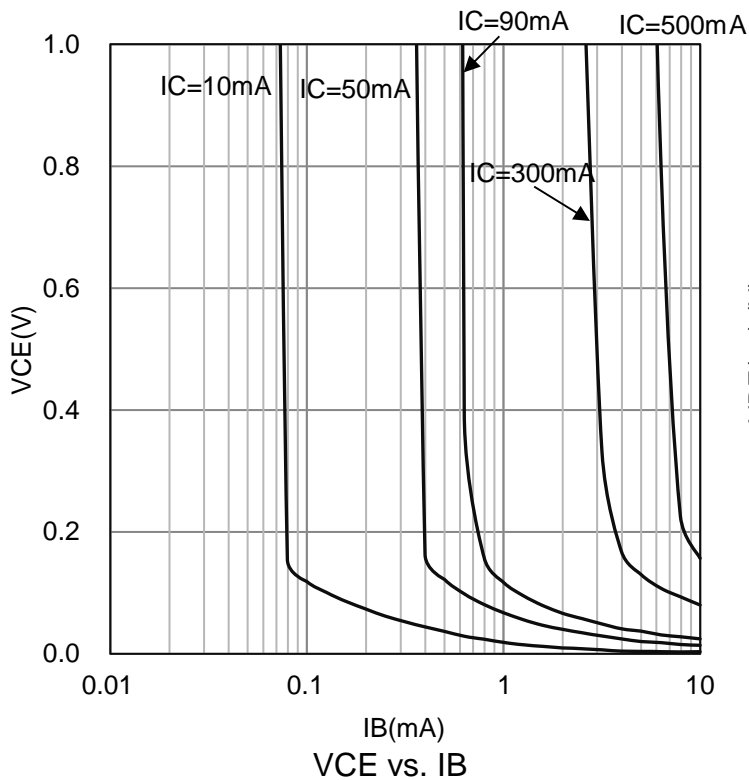
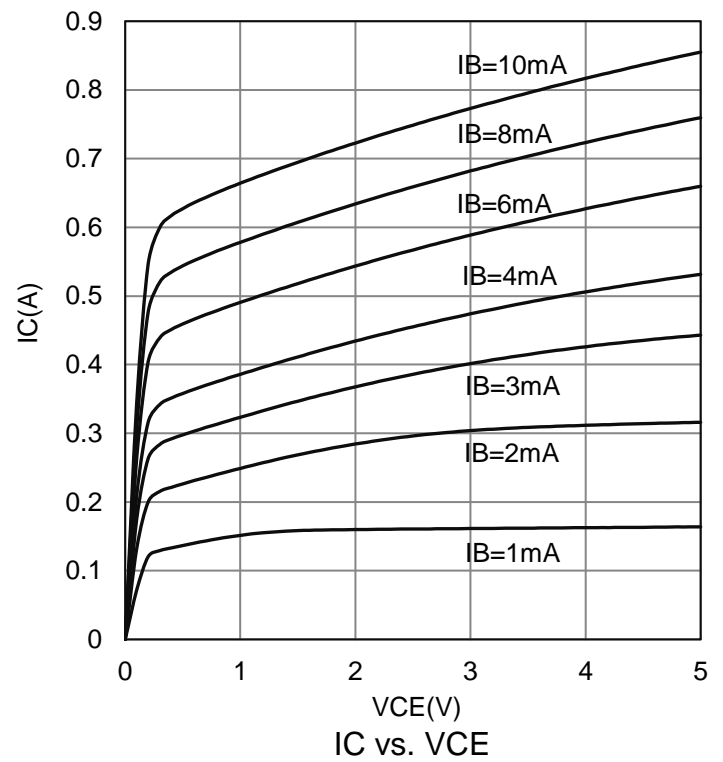
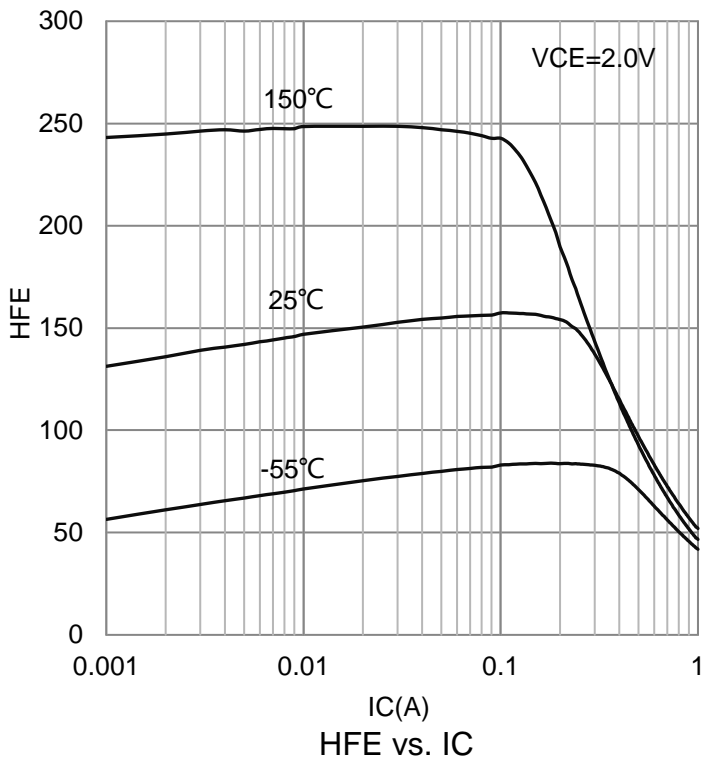

6.ELECTRICAL CHARACTERISTICS CURVES(Con.)

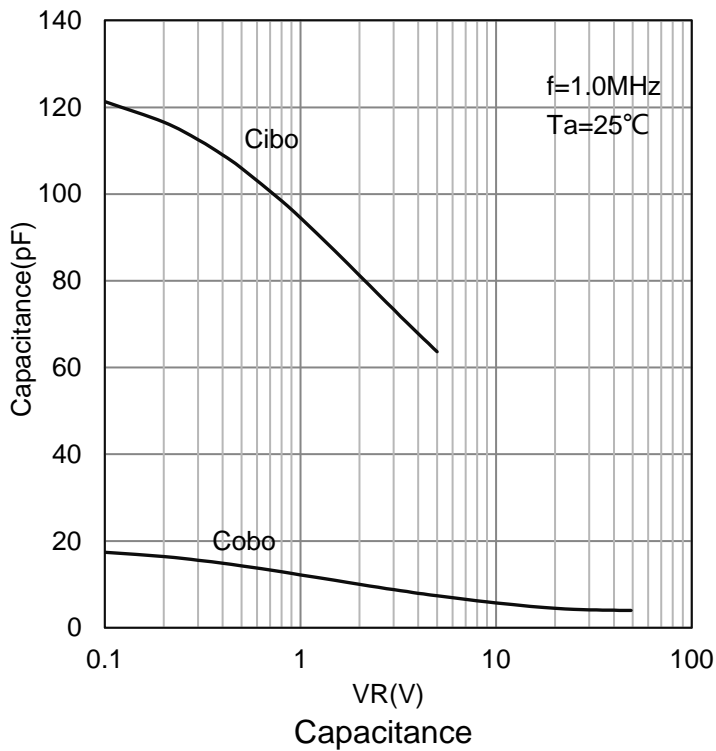
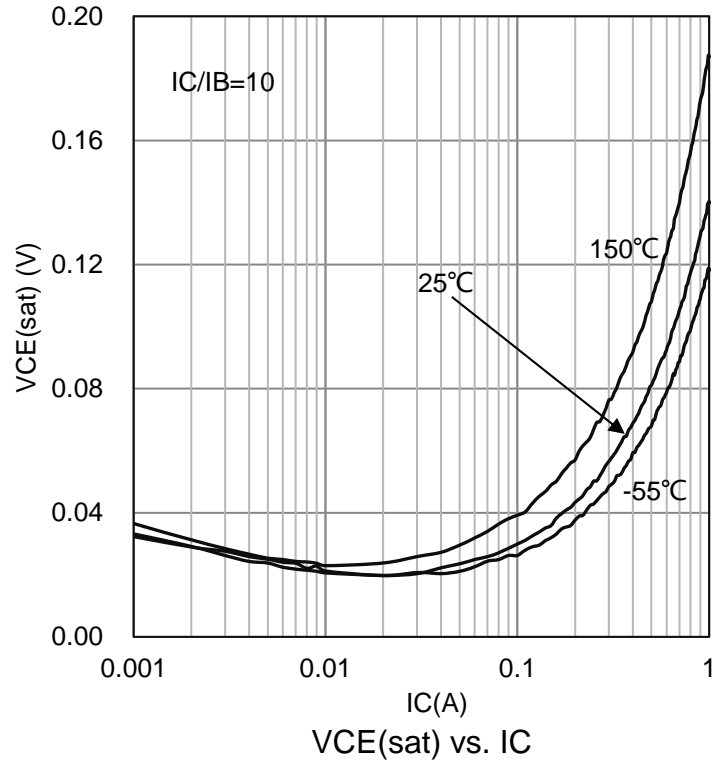
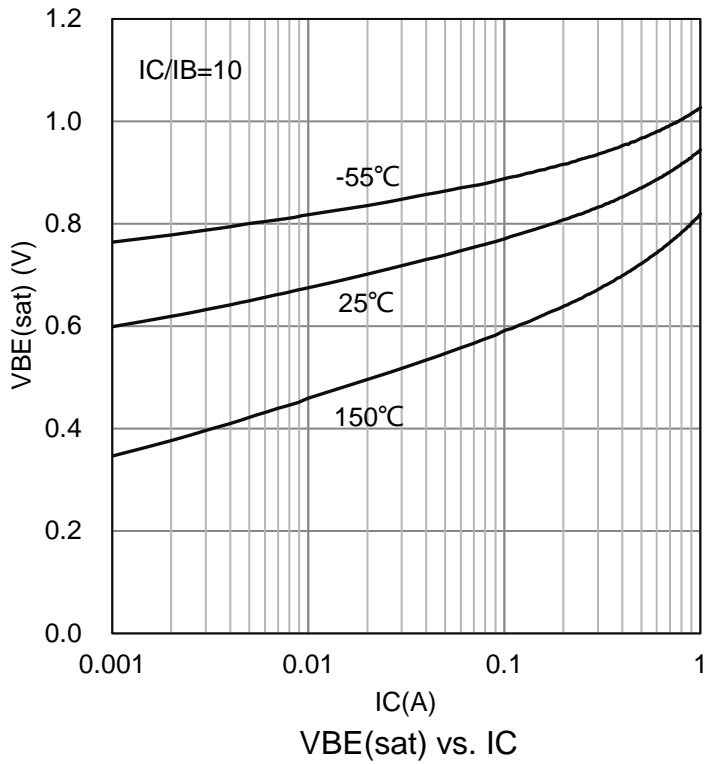

7. OUTLINE AND DIMENSIONS

SOT223

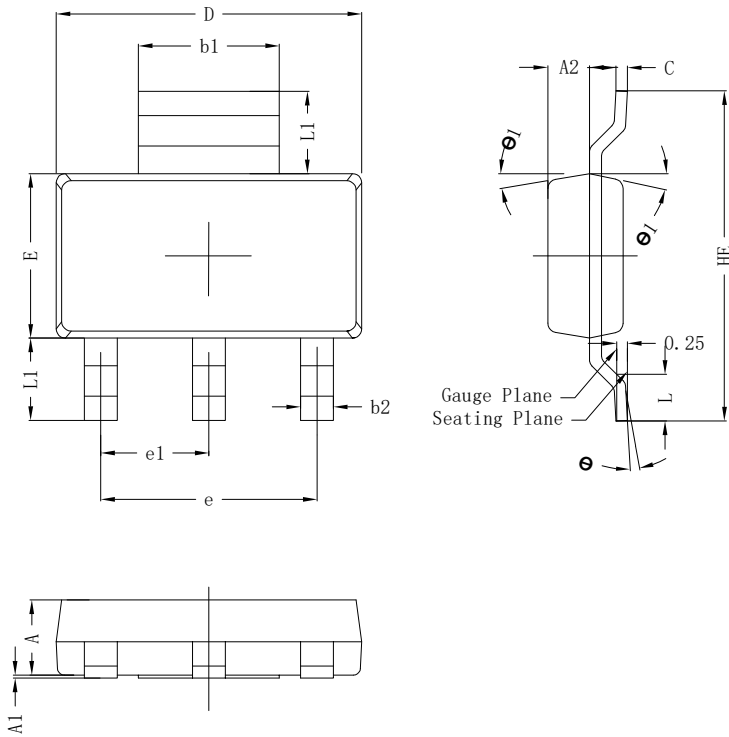

SOT223			
DIM	MIN	NOR	MAX
A	1.50	1.60	1.70
A1	0.00	0.05	0.10
A2	0.80	0.90	1.00
b1	2.90	3.02	3.10
b2	0.60	0.72	0.80
c	0.20	0.27	0.35
D	6.30	6.50	6.70
E	3.30	3.50	3.70
e	4.60BSC		
e1	2.30BSC		
HE	6.80	7.00	7.20
L	0.80	1.00	1.20
L1	1.75(REF)		
θ	0°~8°		
θ 1	8°	10°	12°
All Dimensions in mm			

GENERAL NOTES

1. Top package surface finish Ra0.4±0.2um
2. Bottom package surface finish Ra0.7±0.2um
3. Side package surface finish Ra0.4±0.2um
4. Protrusion or Gate Burrs shall not exceed 0.10mm per side.

8. SOLDERING FOOTPRINT

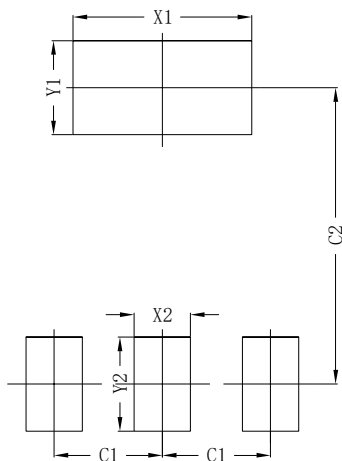

SOT223	
DIM	(mm)
X1	3.80
Y1	2.00
X2	1.20
Y2	2.00
C1	2.30
C2	6.30

DISCLAIMER

- Curve guarantee in the specification. The curve of test items with electric parameter is used as quality guarantee. The curve of test items without electric parameter is used as reference only.
- Before you use our Products for new Project, you are requested to carefully read this document and fully understand its contents. LRC shall not be in any way responsible or liable for failure, malfunction or accident arising from the use of any LRC's Products against warning, caution or note contained in this document.
- All information contained in this document is current as of the issuing date and subject to change without any prior notice. Before purchasing or using LRC's Products, please confirm the latest information with a LRC sales representative.

X-ON Electronics

Largest Supplier of Electrical and Electronic Components

Click to view similar products for [Bipolar Transistors - BJT category](#):

Click to view products by [Leshan manufacturer](#):

Other Similar products are found below :

[BC559C](#) [MCH4017-TL-H](#) [MMBT-2369-TR](#) [BC546/116](#) [NJVMJD148T4G](#) [NTE16](#) [NTE195A](#) [IMX9T110](#) [2N4401-A](#) [2N6728](#) [2SA1419T-TD-H](#) [2SA2126-E](#) [2SB1204S-TL-E](#) [FMC5AT148](#) [2N2369ADCSM](#) [2N2907A](#) [2N3904-NS](#) [2N5769](#) [2SC4618TLN](#) [CPH6501-TL-E](#) [MCH4021-TL-E](#) [US6T6TR](#) [BAX18/A52R](#) [BC556/112](#) [IMZ2AT108](#) [MMST8098T146](#) [UMX21NTR](#) [MCH6102-TL-E](#) [TTA1452B,S4X\(S](#) [2N3879](#) [NTE13](#) [NTE282](#) [NTE323](#) [NTE350](#) [NTE81](#) [JANTX2N2920L](#) [JANTX2N3735](#) [JANSR2N2222AUB](#) [CMLT3946EG TR](#) [SNSS40600CF8T1G](#) [2N6987](#) [CMLT3906EG TR](#) [GRP-DATA-JANS2N2907AUB](#) [GRP-DATA-JANS2N2222AUA](#) [MMDT3946FL3-7](#) [2N4240](#) [JANS2N3019](#) [MSB30KH-13](#) [2N2221AUB](#) [2SD1815T-TL-E](#)