

# SMBJ\*\*\* CA Series

SURFACE MOUNT TRANSIENT VOLTAGE SUPPRESSOR  
VOLTAGE 5.0 TO 440 Volts, 600 Watt Peak Pulse Power

## 1. FEATURES

- We declare that the material of product compliance with RoHS requirements and Halogen Free.
- Plastic package has Underwriters Laboratory Flammability Classification 94V-0
- For surface mounted applications in order to optimize board space
- Low profile package
- Built-in strain relief
- Glass passivated junction
- Low inductance
- Excellent clamping capability
- Repetition Rate (duty cycle): 0.01%
- Fast response time: typically less than 1.0ps
- Typical IR less than 1mA above 10V
- High temperature soldering guaranteed:  
260°C/10 seconds,
- Weight: 0.088g

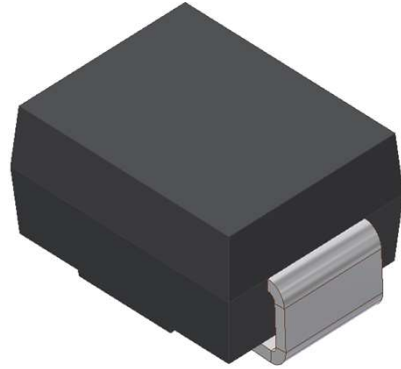

## 2. MECHANICAL DATA

**Case:** Epoxy, Molded

**Terminals:** Plated leads, solderable per MIL-STD-202, Method 208

**Polarity:** Without Color band denoted cathode

**Mounting Position:** Any

## 3. MAXIMUM RATINGS (Ta = 25°C)

Ratings at 25°C ambient temperature unless otherwise specified.

Single phase, half wave, 60Hz, resistive or inductive load.

For capacitive load, derate current by 20%.

RATING	VALUE	UNITS
Peak Power Dissipation at $T_A=25^\circ\text{C}$ , $T_P=1\text{ms}$ (Note 1)	Minimum 600	Watts
Steady State Power Dissipation at $T_L=75^\circ\text{C}$	3.0	Watts
Operating Temperature Range	-55 to +150	°C
Storage Temperature Range	-55 to +150	°C
Max junction capacitance at 4.0V, 1MHz	550	PF

NOTES:

1. Non-repetitive current pulse, per Fig. 3 and derated above  $T_A=25^\circ\text{C}$  per Fig. 2.

## SMBJ\*\*\* CA Series

Bi-Directional Part Number	Device marking code	Reverse Stand-off Voltage VRWM (V)	Breakdown Voltage VBR (V)	Breakdown Voltage VBR (V)	Test Current IT (mA)	Maximum Clamping Voltage @IPP VC (V)	Peak Pulse Current Ipp (A)	Reverse Leakage @VRWM IR (uA)
			Min. @IT	Max. @IT				
SMBJ5.0CA	SMBJ5.0CA	5.00	6.40	7.00	10.00	9.20	65.30	800
SMBJ6.0CA	SMBJ6.0CA	6.00	6.67	7.37	10.00	10.30	58.30	800
SMBJ6.5CA	SMBJ6.5CA	6.50	7.22	7.98	10.00	11.20	53.60	500
SMBJ7.0CA	SMBJ7.0CA	7.00	7.78	8.60	10.00	12.00	50.00	200
SMBJ7.5CA	SMBJ7.5CA	7.50	8.33	9.21	1.00	12.90	46.60	100
SMBJ8.0CA	SMBJ8.0CA	8.00	8.89	9.83	1.00	13.60	44.20	50
SMBJ8.5CA	SMBJ8.5CA	8.50	9.44	10.40	1.00	14.40	41.70	20
SMBJ9.0CA	SMBJ9.0CA	9.00	10.00	11.10	1.00	15.40	39.00	10
SMBJ10CA	SMBJ10CA	10.00	11.10	12.30	1.00	17.00	35.30	1
SMBJ11CA	SMBJ11CA	11.00	12.20	13.50	1.00	18.20	33.00	1
SMBJ12CA	SMBJ12CA	12.00	13.30	14.70	1.00	19.90	30.20	1
SMBJ13CA	SMBJ13CA	13.00	14.40	15.90	1.00	21.50	28.00	1
SMBJ14CA	SMBJ14CA	14.00	15.60	17.20	1.00	23.20	25.90	1
SMBJ15CA	SMBJ15CA	15.00	16.70	18.50	1.00	24.40	24.60	1
SMBJ16CA	SMBJ16CA	16.00	17.80	19.70	1.00	26.00	23.10	1
SMBJ17CA	SMBJ17CA	17.00	18.90	20.90	1.00	27.60	21.80	1
SMBJ18CA	SMBJ18CA	18.00	20.00	22.10	1.00	29.20	20.60	1
SMBJ20CA	SMBJ20CA	20.00	22.20	24.50	1.00	32.40	18.60	1
SMBJ22CA	SMBJ22CA	22.00	24.40	26.90	1.00	35.50	16.90	1
SMBJ24CA	SMBJ24CA	24.00	26.70	29.50	1.00	38.90	15.50	1
SMBJ26CA	SMBJ26CA	26.00	28.90	31.90	1.00	42.10	14.30	1
SMBJ28CA	SMBJ28CA	28.00	31.10	34.40	1.00	45.40	13.30	1
SMBJ30CA	SMBJ30CA	30.00	33.30	36.80	1.00	48.40	12.40	1
SMBJ33CA	SMBJ33CA	33.00	36.70	40.60	1.00	53.30	11.30	1
SMBJ36CA	SMBJ36CA	36.00	40.00	44.20	1.00	58.10	10.40	1
SMBJ40CA	SMBJ40CA	40.00	44.40	49.10	1.00	64.50	9.30	1
SMBJ43CA	SMBJ43CA	43.00	47.80	52.80	1.00	69.40	8.70	1
SMBJ45CA	SMBJ45CA	45.00	50.00	55.30	1.00	72.70	8.30	1
SMBJ48CA	SMBJ48CA	48.00	53.30	58.90	1.00	77.40	7.80	1
SMBJ51CA	SMBJ51CA	51.00	56.70	62.70	1.00	82.40	7.30	1
SMBJ54CA	SMBJ54CA	54.00	60.00	66.30	1.00	87.10	6.90	1
SMBJ58CA	SMBJ58CA	58.00	64.40	71.20	1.00	93.60	6.50	1
SMBJ60CA	SMBJ60CA	60.00	66.70	73.70	1.00	96.80	6.20	1
SMBJ64CA	SMBJ64CA	64.00	71.10	78.60	1.00	103.00	5.90	1
SMBJ70CA	SMBJ70CA	70.00	77.80	86.00	1.00	113.00	5.30	1
SMBJ75CA	SMBJ75CA	75.00	83.30	92.10	1.00	121.00	5.00	1
SMBJ78CA	SMBJ78CA	78.00	86.70	95.80	1.00	126.00	4.80	1
SMBJ85CA	SMBJ85CA	85.00	94.40	104.00	1.00	137.00	4.40	1
SMBJ90CA	SMBJ90CA	90.00	100.00	111.00	1.00	146.00	4.10	1
SMBJ100CA	SMBJ100CA	100.00	111.00	123.00	1.00	162.00	3.70	1
SMBJ110CA	SMBJ110CA	110.00	122.00	135.00	1.00	177.00	3.40	1
SMBJ120CA	SMBJ120CA	120.00	133.00	147.00	1.00	193.00	3.10	1
SMBJ130CA	SMBJ130CA	130.00	144.00	159.00	1.00	209.00	2.90	1
SMBJ150CA	SMBJ150CA	150.00	167.00	185.00	1.00	243.00	2.50	1
SMBJ160CA	SMBJ160CA	160.00	178.00	197.00	1.00	259.00	2.30	1
SMBJ170CA	SMBJ170CA	170.00	189.00	209.00	1.00	275.00	2.20	1
SMBJ180CA	SMBJ180CA	180.00	198.00	221.00	1.00	291.00	2.10	1
SMBJ190CA	SMBJ190CA	190.00	209.00	233.00	1.00	307.00	2.00	1
SMBJ200CA	SMBJ200CA	200.00	220.00	246.00	1.00	324.00	1.90	1
SMBJ220CA	SMBJ220CA	220.00	246.00	272.00	1.00	356.00	1.70	1
SMBJ250CA	SMBJ250CA	250.00	279.00	309.00	1.00	405.00	1.50	1
SMBJ300CA	SMBJ300CA	300.00	335.00	371.00	1.00	486.00	1.30	1
SMBJ350CA	SMBJ350CA	350.00	391.00	432.00	1.00	567.00	1.10	1
SMBJ400CA	SMBJ400CA	400.00	447.00	494.00	1.00	648.00	0.90	1
SMBJ440CA	SMBJ440CA	440.00	492.00	543.00	1.00	713.00	0.90	1

### 5. ELECTRICAL CHARACTERISTICS CURVES

Fig. 1-Peak Pulse Power Rating Curve

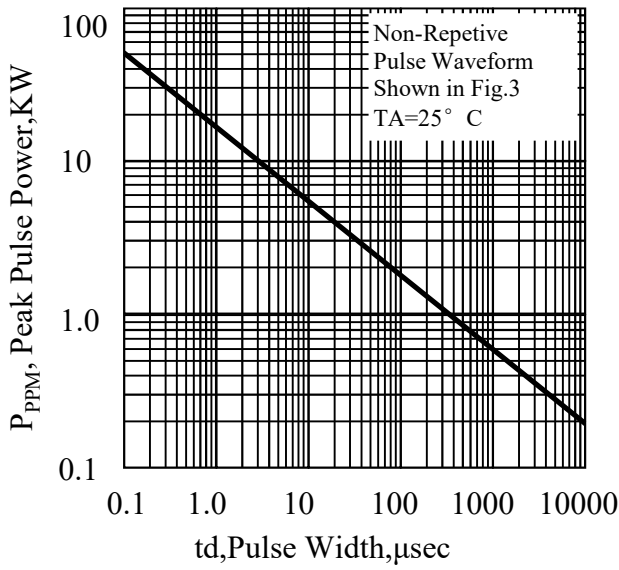

Fig. 2-Pulse Derating Curve

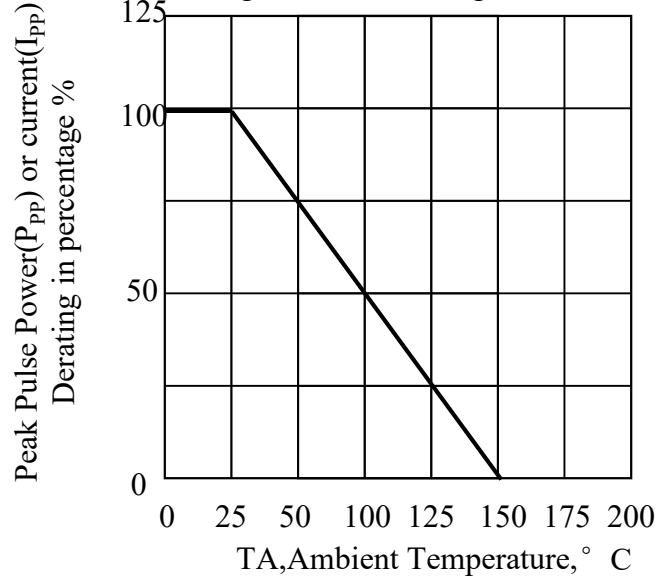

Fig. 3-Pulse Waveform

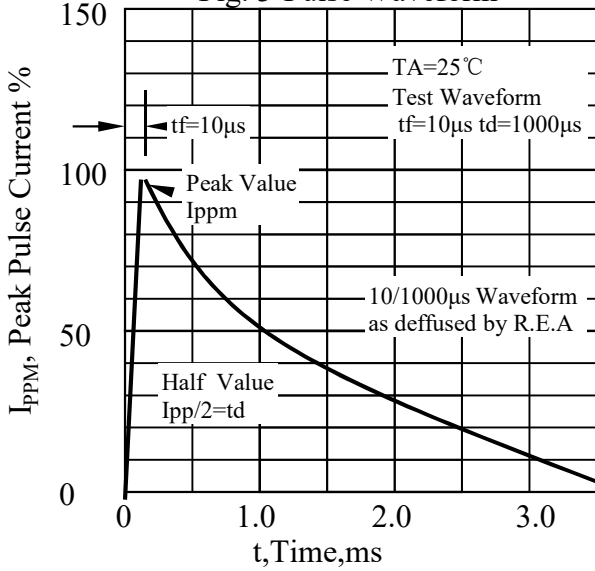
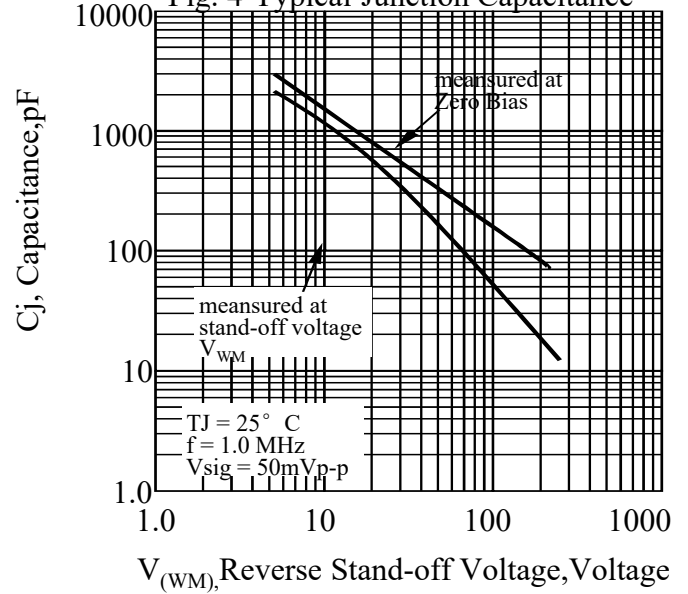
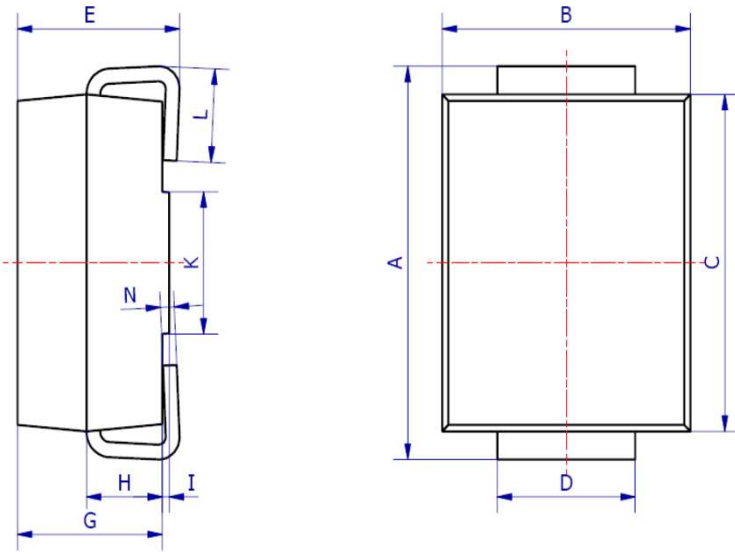

Fig. 4-Typical Junction Capacitance



## 6. OUTLINE AND DIMENSIONS



SMB			
DIM	Min	Max	Typ.
A	5.00	5.45	5.25
B	3.20	4.00	3.60
C	4.30	4.70	4.50
D	1.80	2.20	2.00
E	2.20	2.50	2.35
G	1.90	2.30	2.10
H	0.95	1.25	1.10
I	0.05	0.15	0.10
K	1.70	2.10	1.90
L	0.90	1.50	1.20
N	0.10	0.30	0.20
All Dimensions in mm			

## 7. SOLDERING FOOTPRINT

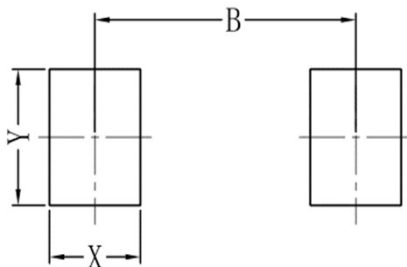

SMB	
DIM	(mm)
X	1.60
Y	2.20
B	4.60

## X-ON Electronics

Largest Supplier of Electrical and Electronic Components

*Click to view similar products for [ESD Suppressors / TVS Diodes](#) category:*

*Click to view products by [Leshan](#) manufacturer:*

Other Similar products are found below :

[60KS200C](#) [D18V0L1B2LP-7B](#) [D5V0F4U5P5-7](#) [NTE4902](#) [P4KE27CA](#) [P6KE11CA](#) [P6KE39CA-TP](#) [P6KE8.2A](#) [JANTX1N6053A](#)  
[SA110CA](#) [SA60CA](#) [SA64CA](#) [SMBJ12CATR](#) [SMBJ33CATR](#) [SMBJ8.0A](#) [ESD101-B1-02ELS E6327](#) [ESD105-B1-02EL E6327](#) [ESD112-B1-02EL E6327](#) [ESD119B1W01005E6327XTSA1](#) [ESD5V0L1B02VH6327XTSA1](#) [ESD7451N2T5G](#) [19180-510](#) [CPDT-5V0USP-HF](#)  
[3.0SMCJ33CA-F](#) [3.0SMCJ36A-F](#) [HSPC16701B02TP](#) [JANTX1N6126A](#) [JANTX1N6462](#) [JANTX1N6465](#) [USB50805e3/TR7](#)  
[D3V3Q1B2DLP3-7](#) [D55V0M1B2WS-7](#) [DRTR5V0U4SL-7](#) [SCM1293A-04SO](#) [ESD200-B1-CSP0201 E6327](#) [SM12-7](#) [SM1605E3/TR13](#)  
[SMLJ45CA-TP](#) [CEN955 W/DATA](#) [82350120560](#) [VESD12A1A-HD1-GS08](#) [CPDUR5V0R-HF](#) [CPDQC5V0U-HF](#) [CPDQC5V0USP-HF](#)  
[CPDQC5V0-HF](#) [D1213A-01LP4-7B](#) [ESD101-B1-02EL E6327](#) [824500181](#) [MMAD1108/TR13](#) [5KP100A](#)