

# SODSF11-SH thru SODSF18-SH

Surface Mount Glass Passivated Junction Fast Recovery Rectifiers

Reverse Voltage 50 to 600V Forward Current 1.0A

## FEATURES

- \* Plastic package has Underwriters Laboratory Flammability Classification 94V-0
- \* High temperature metallurgically bonded construction
- \* Cavity-free glass passivated junction
- \* Capable of meeting environmental standards of MIL-S-19500
- \* Typical IR less than 1.0 $\mu$ A
- \* High temperature soldering guaranteed: 260°C/10 seconds

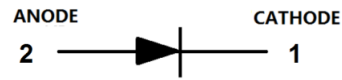
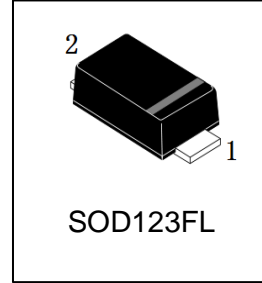

## Mechanical Data

**Case:** JEDEC SOD123-FL/MINI SMA, molded plastic over glass DIE

**Terminals:** Tin Plated, solderable per MIL-STD-750, Method 2026

**Polarity:** Color band denotes cathode end

**Mounting Position:** Any

**Weight:** 0.0155 g

**Handling precaution:** None

## Electrical Characteristic

### 1. Maximum & Thermal Characteristics Ratings at 25°C ambient temperature unless otherwise specified.

Parameter Symbol	symbol	SOD SF11-SH	SOD SF12-SH	SOD SF13-SH	SOD SF14-SH	SOD SF15-SH	SOD SF16-SH	SOD SF17-SH	SOD SF18-SH	Unit
Device marking code		SF11	SF12	SF13	SF14	SF15	SF16	SF17	SF18	
Maximum repetitive peak reverse voltage	$V_{RRM}$	50	100	150	200	300	400	500	600	V
Maximum RMS voltage	$V_{RMS}$	35	70	105	140	210	280	350	420	V
Maximum DC blocking voltage	$V_{DC}$	50	100	150	200	300	400	500	600	V
Maximum average forward rectified current lead length at $T_C = 75^\circ\text{C}$ (Note 2)	$I_{F(AV)}$	1.0								A
Peak forward surge current 8.3ms single half sine-wave superimposed on rated load (JEDEC Method)	$I_{FSM}$	30								A
Typical reverse recovery time (Note 1)	$t_{rr}$	35								ns
Typical thermal resistance (Note 2)	$R\theta_{JA}$ $R\theta_{JL}$	170 40								$^\circ\text{C/W}$
Operating junction temperature range	$T_J$	-55 to +150								$^\circ\text{C}$
storage temperature range	$T_{STG}$	-55 to +150								$^\circ\text{C}$

### Electrical Characteristics Ratings at 25°C ambient temperature unless otherwise specified.

Parameter Symbol	symbol	SOD SF11-SH	SOD SF12-SH	SOD SF13-SH	SOD SF14-SH	SOD SF15-SH	SOD SF16-SH	SOD SF17-SH	SOD SF18-SH	Unit
Maximum instantaneous forward voltage at 1.0A	$V_F$	0.95			1.25		1.7			V
Maximum DC reverse current at rated DC blocking voltage $T_A = 25^\circ\text{C}$ $T_J = 100^\circ\text{C}$	$I_R$	5.0 100								$\mu\text{A}$
Typical junction capacitance at 4.0V, 1MHz (Note 2)	$C_J$	15.0								PF

#### NOTES:

1.  $I_F = 0.5\text{A}$ ,  $I_R = 1.0\text{A}$ ,  $I_{RR} = 0.25\text{A}$
2. 8.0mm<sup>2</sup> (.013mm thick) land areas

# SODSF11-SH thru SODSF18-SH

## 2. Characteristic Curves (TA = 25°C unless otherwise noted)

Fig. 1 – Forward Current Derating Curve

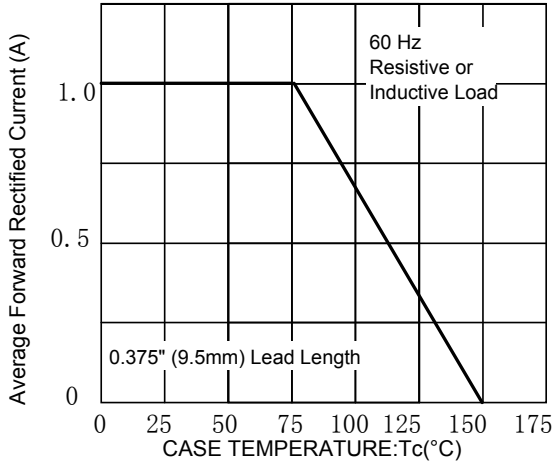

Fig. 2 – Maximum Non-repetitive Peak Forward Surge Current

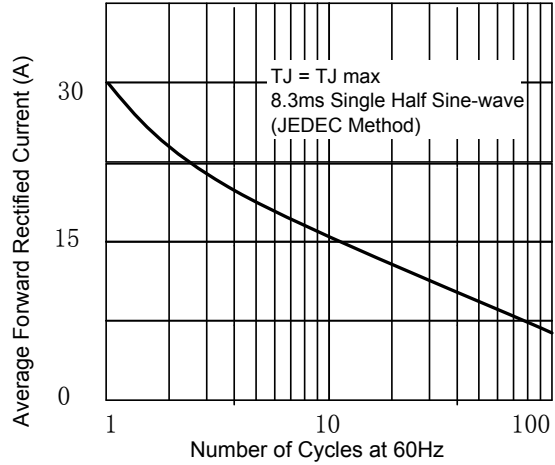

Fig 3. – Typical Instantaneous Forward Characteristics

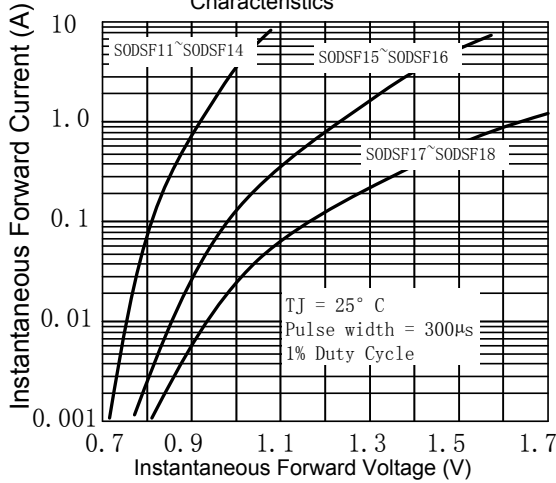

Fig 4. – Typical Reverse Characteristics

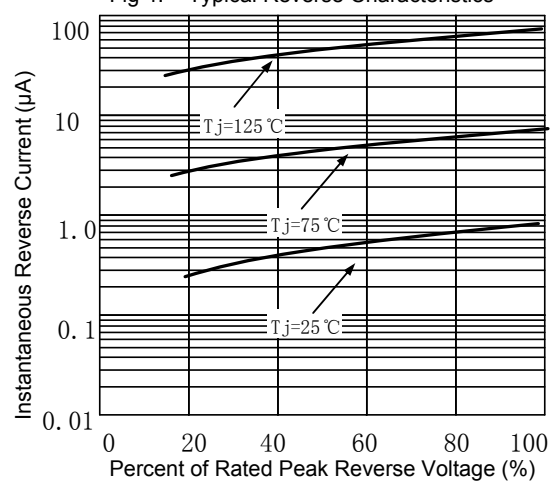

Fig 5. – typical transient thermal impedance

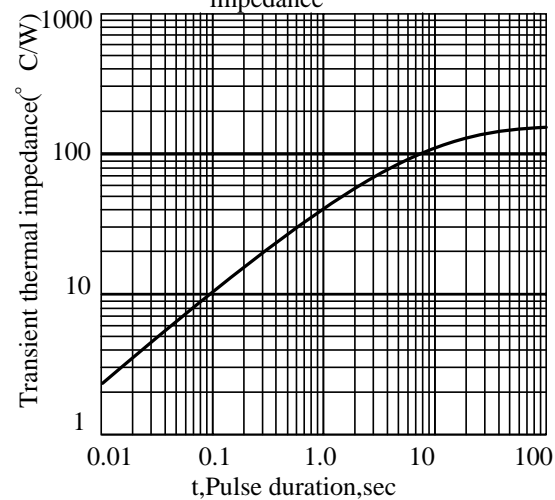
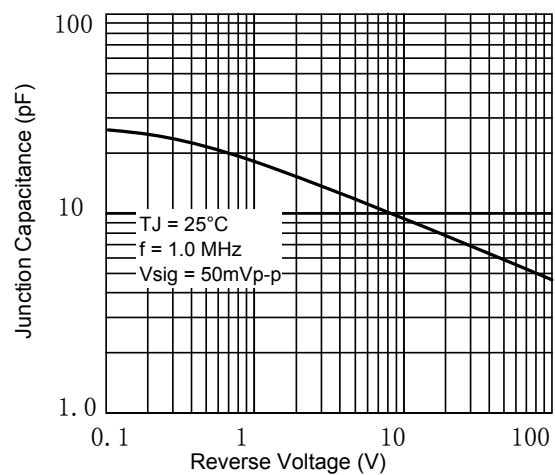
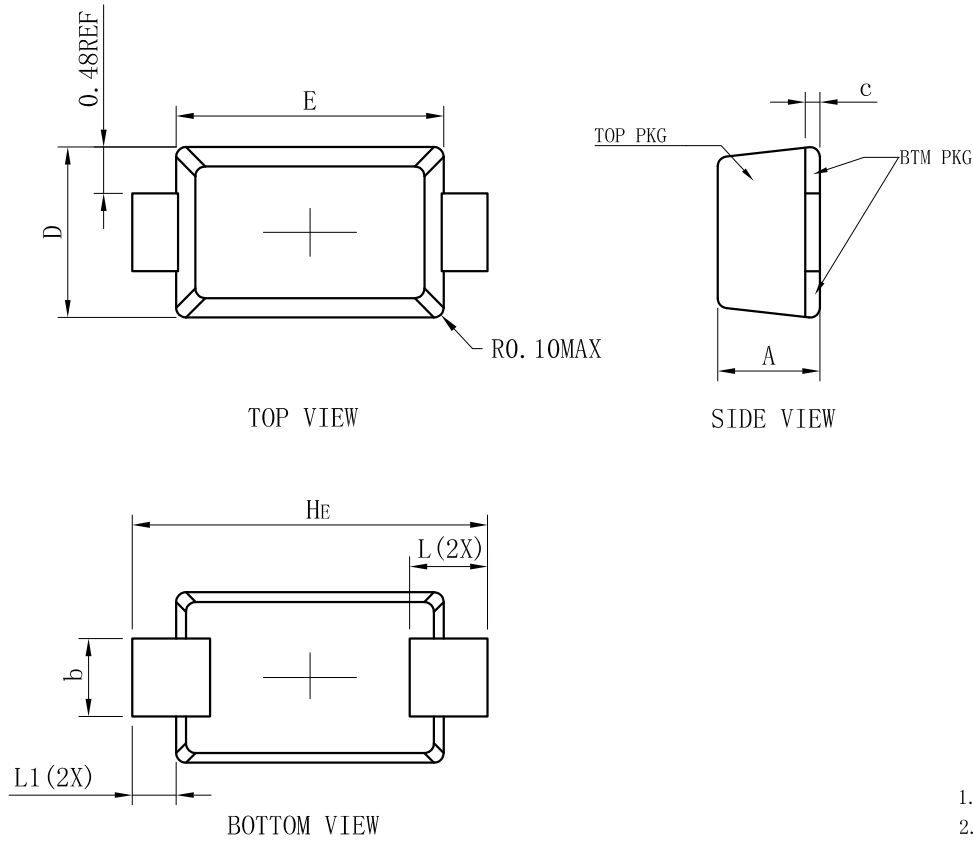

Fig 6. – Typical Junction Capacitance



### 3.OUTLINE AND DIMENSIONS



SOD123FL			
DIM	MIN	NOR	MAX
A	0.90	1.05	1.15
b	0.75	0.80	0.95
L	0.80REF.		
E	2.60	2.75	2.90
D	1.60	1.75	1.90
$H_E$	3.50	3.65	3.80
c	0.12	0.17	0.22
L1	0.45REF.		
All Dimensions in mm			

#### GENERAL NOTES

- 1.Top package surface finish  $Ra0.4\pm0.2\mu\text{m}$
- 2.Bottom package surface finish  $Ra0.7\pm0.2\mu\text{m}$
- 3.Side package surface finish  $Ra0.4\pm0.2\mu\text{m}$

### 4.SOLDERING FOOTPRINT

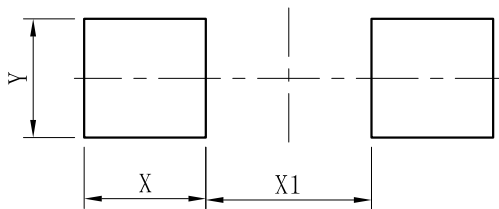

DIM	(mm)
X	1.20
Y	1.10
X1	2.00

# SODSF11-SH thru SODSF18-SH

## 5. Suggested thermal profile for soldering process

1. Storage environment : Temperature=5~40°C Humidity=55±25%
2. Reflow soldering of surface-mount device

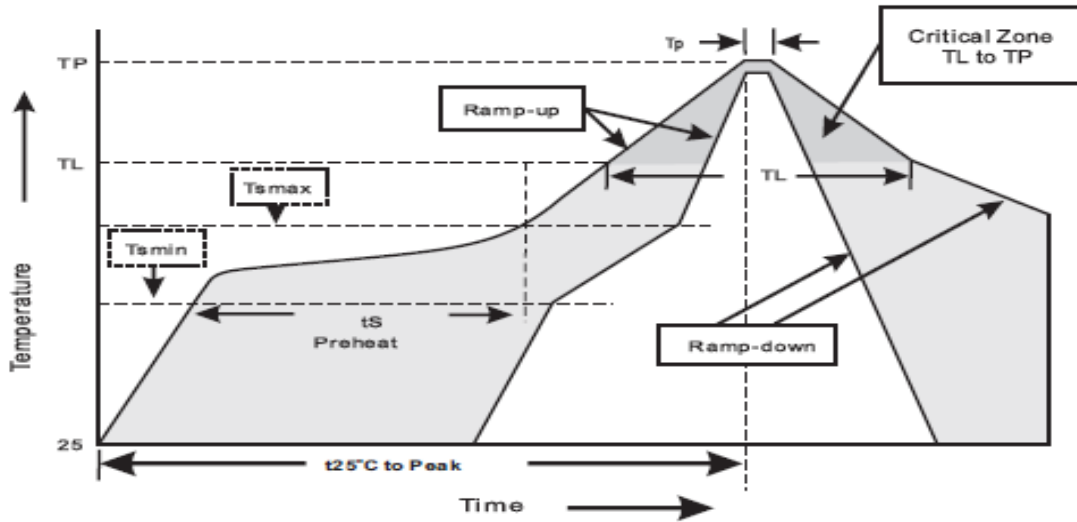

3. Reflow soldering

Profile Feature	Soldering Condition
Average ramp-up rate(T <sub>L</sub> to T <sub>P</sub> )	<3°C/sec
Preheat - Temperature Min(T <sub>smin</sub> ) - Temperature Max(T <sub>smax</sub> ) - Time(min to max)(t <sub>s</sub> )	150°C 200°C 60~120sec
T <sub>smax</sub> to T <sub>L</sub> - Ramp-up Rate	<3sec
Time maintained above: - Temperature (T <sub>L</sub> ) - Time(t <sub>L</sub> )	217°C 60-260sec
Peak Temperature(T <sub>P</sub> )	255 -0/+5°C
Time within 5°C of actual Peak Temperature(T <sub>P</sub> )	10~30sec
Ramp-down Rate	<6°C/sec
Time 25°C to Peak Temperature	<6minutes

## SODSF11-SH thru SODSF18-SH

### 6.High reliability test capabilities

Item Test	Condition	Reference
Solder Resistance	at 260±5°C for 10±2sec immerse body into solder 1/16" ± 1/32"	MIL-STD-750D METHOD-2031
Solderability	at 245±5°C for 5 sec	MIL-STD-202F METHOD-208
High Temperature Reverse Bias	VR=80% rate at Tj=150°C for 168hrs	MIL-STD-750D METHOD-1038
Forward Operation Life	Rated average rectifier current TA=25°C for 500hrs	MIL-STD-750D METHOD-1027
Intermittent Operation Life	TA=25°C , IF=Io On state:power on for 5 min. Off state:power off for 5 min. on and off for 500 cycles	MIL-STD-750D METHOD-1036
Pressure Cooker	15P <sub>SIG</sub> at TA=121°C for 4hrs	JESD22-A102
Temperature Cycling	-55°C to +125°C dwelled for 30 min. and transferred for 5min. Total 10 cycles	MIL-STD-750D METHOD-1051
Thermal Shock	0°C for 5min. Rise to 100°C for 5min. Total 10 cycles	MIL-STD-750D METHOD-1056
Forward Surge	8.3ms single half sine-wave superimposed on rated load,one surge	MIL-STD-750D METHOD-4066-2
Humidity	at TA=85°C , RH=85% for 1000hrs	MIL-STD-750D METHOD-1021
High Temperature Storage Life	at 175°C for 1000hrs	MIL-STD-750D METHOD-1031



Proprietary Information

# Title: Power Packages Product Packing Specification

## 功率产品包装规范

Document Number: APS-QA-QS-009

Revision C

Page 3 of 6



8.1.2 Label position and QA stamp position.(Empty area) 标签张贴位置及QA印章位置。(印章盖在标签空白区)



7英寸卷盘标签张贴及QA印章位置



13英寸卷盘标签张贴及QA印章位置

8.1.3 Ensure direction In the same reel. The same steel coil plate direction, With antistatic bubble to package reel. Refer to the below picture.  
同一箱内的卷盘方向一致,用防静电泡沫对卷盘进行包裹。

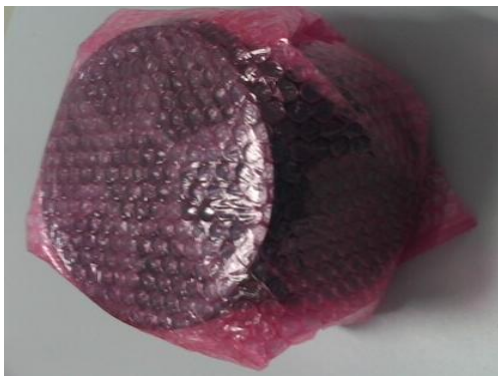

7英寸卷盘防静电泡沫包裹



13英寸卷盘防静电泡沫包裹



Proprietary Information

# Title: Power Packages Product Packing Specification

## 功率产品包装规范

Document Number: APS-QA-QS-009

Revision C

Page 4 of 6

8.1.4 Put in the antistatic packing box after packaged reels. And QA stamp on the box label .

将包装好的卷盘放入防静电纸箱中，并在盒标签上盖章。



7 英寸卷盘内盒及标签



13 英寸卷盘内盒及标签

8.1.5 Product use printing inner box. 产品使用LRC印字内箱。



7英寸卷盘内箱印字（侧面）



13英寸卷盘内箱印字（正面）

8.1.6 Inner box packing quantity requirement. 内盒包装数量要求。

Product Description	QTY
SOD123-FL	1-10Reels
SOD323-HE	1-10Reels
SMA-FL	1-7Reels
SMB-FL	1-4Reels

8.1.7 With transparent tape sealing. 透明胶带封箱。



Proprietary Information

# Title: Power Packages Product Packing Specification

## 功率产品包装规范

Document Number: APS-QA-QS-009

Revision C

Page 5 of 6



7英寸内箱封盒



13英寸内箱封盒

### 8.1.8 Outer box size and packing quantity requirement, 外箱尺寸及包装数量要求。

Product Description	卷盘尺寸	Height (H)	Width (W)	Length (L)	Max. Qty
Power Device	7 英寸	410mm	400mm	445mm	12
Power Device	13 英寸	410mm	400mm	445mm	5



7 英寸卷盘产品装箱



13 英寸卷盘产品装箱

统一方向





Proprietary Information

# Title: Power Packages Marking & Taping Specification

## 功率封装字模和编带规范

Document Number: APS-QA-QS-010

Revision C

Page 6 of 9

### 8.2 Standard Products Taping Specification

标准产品编带规范

#### 8.2.1 Tape length of no component

空带长度说明

Taping leader length 引导部分:  $440\text{mm} \pm 40\text{mm}$  , Tape trailer 尾部:  $200\text{mm} \pm 40\text{mm}$

Figure 4

Tape Ends For Finished Goods Reel

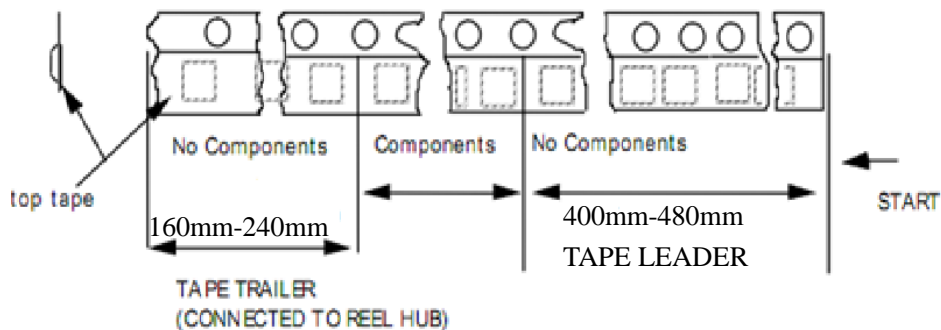

#### 8.2.2 Component packaging orientation: The cathode lead is close to the carrier tape's index hole.

产品放置方向: 印阴极带引脚邻近载带索引孔





Proprietary Information

# Title: Power Packages Marking & Taping Specification

功率封装字模和编带规范

Document Number: APS-QA-QS-010

Revision C

Page 7 of 9

## 8.2.3 Tape enwind orientation

编带缠绕方向要求

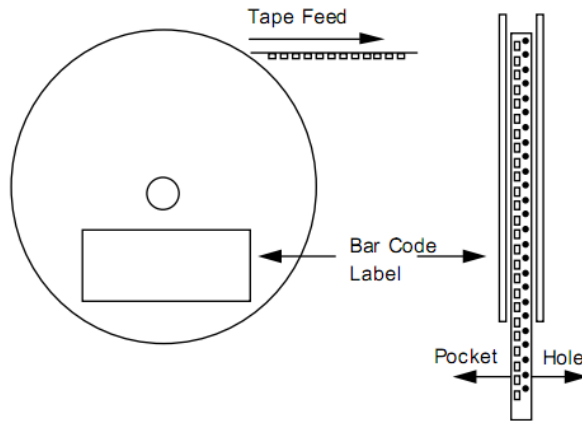

## X-ON Electronics

Largest Supplier of Electrical and Electronic Components

*Click to view similar products for [Rectifiers](#) category:*

*Click to view products by [Leshan](#) manufacturer:*

Other Similar products are found below :

[D91A](#) [DA24F4100L](#) [DD89N1600K-A](#) [DD89N16K-K](#) [RL252-TP](#) [DLA11C-TR-E](#) [DSA17G](#) [1N4005-TR](#) [BAV199-TP](#) [UFS120Je3/TR13](#)  
[JANS1N6640US](#) [VS-80-1293](#) [DD89N16K](#) [DD89N16K-A](#) [481235F](#) [DSP10G-TR-E](#) [067907F](#) [MS306](#) [ND104N08K](#) [SPA2003-B-D-A01](#) [VS-](#)  
[80-6193](#) [VS-66-9903](#) [VGF0136AB](#) [US2JFL-TP](#) [UFS105Je3/TR13](#) [A1N5404G-G](#) [ACGRA4007-HF](#) [ACGRB207-HF](#) [RF301B2STL](#)  
[RF501B2STL](#) [UES1306](#) [UES1302](#) [BAV199E6433HTMA1](#) [ACGRC307-HF](#) [ACEFC304-HF](#) [JANTXV1N5660A](#) [UES1106](#) [GS2K-LTP](#)  
[D126A45C](#) [D251N08B](#) [SCHJ22.5K](#) [SM100](#) [SCPA2](#) [SCH10000](#) [SDHD5K](#) [STTH20P035FP](#) [VS-8EWS12S-M3](#) [VS-12FL100S10](#)  
[ACGRA4001-HF](#) [MUR420GP-TP](#)