

Photo DMOS-FET Relay

Description

The **LT236** is a miniature 1-Form A solid state relay in a 4 pin SOP package that employs optically coupled MOSFET technology to provide 1500V of input to output isolation. The optically coupled input is controlled by a highly efficient GaAlAs infrared LED and MOS FETs on the output side.

Features

- SOP package 4 Pin type in miniature design (4.4×4.3×2.0mm / .173×.169×.083inch)
- Low driver power requirements (TTL/CMOS Compatible)
- Low CxR . Output capacitance=22pF(Typ.)
- No moving parts
- High reliability
- Arc-Free with no snubbing circuits
- 1500Vrms Input/Output isolation
- Tape & Reel version available

Applications

- Telecommunications (PC, Electronic notepad)
- Measuring and Testing equipment
- Industrial control
- Security equipments
- High speed inspection machine

Outline Dimensions

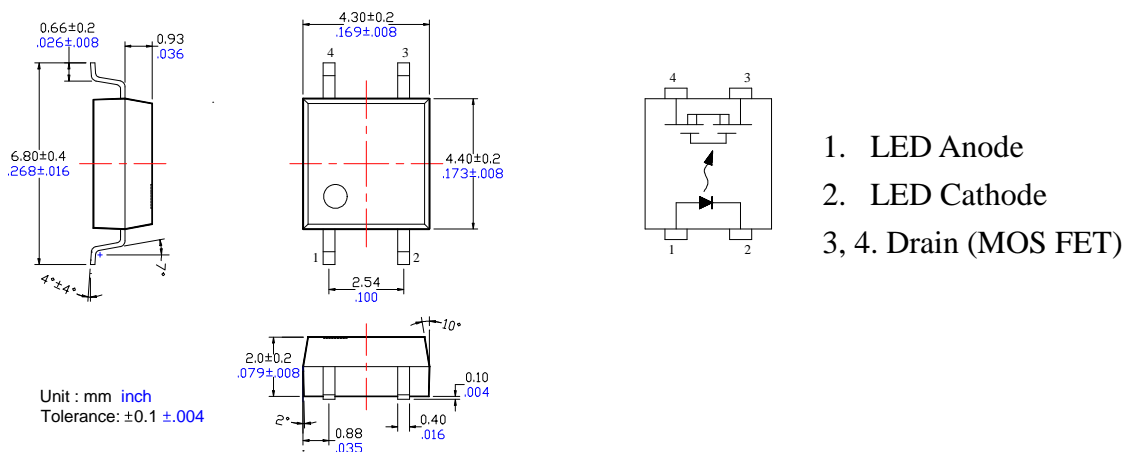

Photo DMOS-FET Relay Specifications

Part Name: LT236

(Load voltage: 100V / Load current: 400mA)

Absolute Maximum Ratings (Ambient Temperature: 25°C)

Item		Symbol	Value	Units	Note
Input	Continuous LED Current	I _F	50	mA	
	Peak LED Current	I _{FP}	1000	mA	f=100Hz, duty=1%
	LED Reverse Voltage	V _R	5	V	
	Input Power Dissipation	P _{In}	75	mW	
Output	Load Voltage	V _L	100	V(AC peak or DC)	
	Load Current	I _L	400	mA	
	Peak Load Current	I _{Peak}	1.0	A	100ms(1 pulse)
	Output Power Dissipation	P _{out}	450	mW	
Total Power Dissipation		P _T	500	mW	
I/O Breakdown Voltage		V _{I/O}	1500	V _{rms}	RH=60%, 1min
Operating Temperature		T _{opr}	-40 to +85	°C	
Storage Temperature		T _{stg}	-40 to +100	°C	
Pin Soldering Temperature		T _{sol}	260	°C	10 sec max.

Electrical Specifications (Ambient Temperature: 25°C)

Item		Symbol	MIN.	TYP.	MAX.	Units	Conditions
Input	LED Forward Voltage	V _F		1.2	1.4	V	I _F =10mA
	Operation LED Current	I _{F on}		0.5	2.0	mA	
	Recovery LED Current	I _{F off}		0.35	3.0	mA	
	Recovery LED Voltage	V _{F off}	0.7			V	
Output	On-Resistance	R _{on}		2.0	2.5	Ω	I _F =5mA, I _L =100mA, Time to flow is within 1 sec.
	Off-State Leakage Current	I _{Leak}			1.0	uA	V _L =Rating
	Output Capacitance	C _{out}		22		pF	V _L =0, f=1MHz
Transmission	Turn-On Time	T _{on}		0.3	0.6	ms	I _F =5mA, I _L =100mA,
	Turn-Off Time	T _{off}		0.05	0.1	ms	
Coupled	I/O Isolation Resistance	R _{I/O}	10 ¹⁰			Ω	DC500V
	I/O Capacitance	C _{I/O}		0.8	1.5	pF	f=1MHz

Reference Data

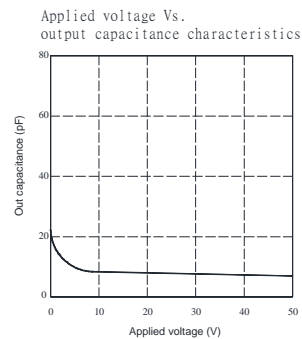
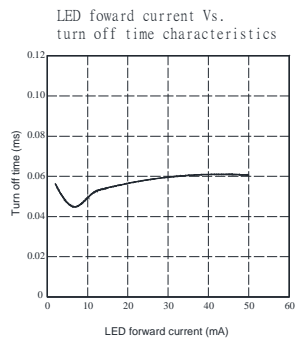
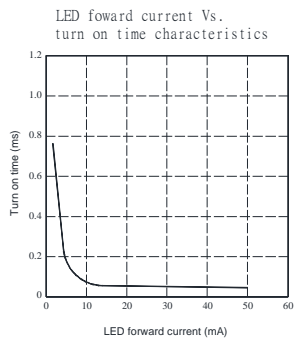
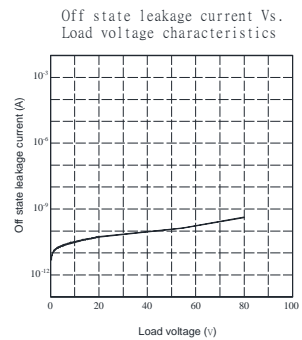
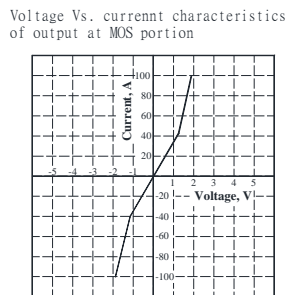
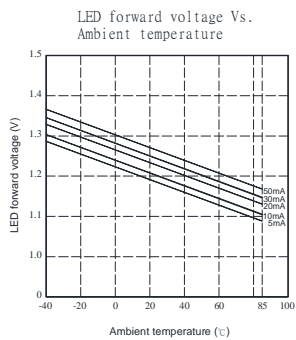
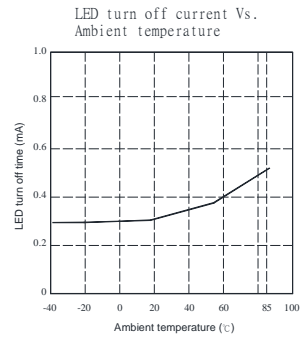
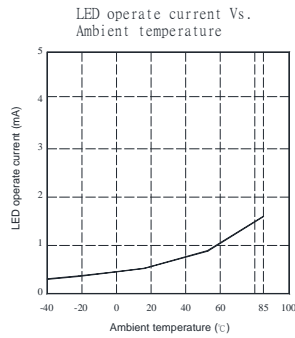
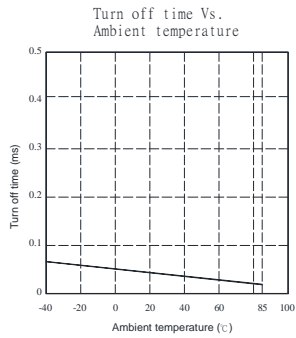
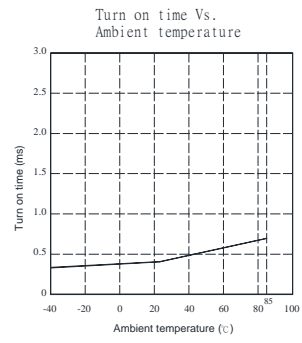
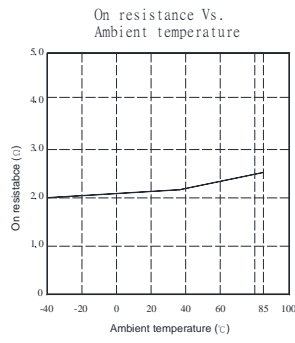
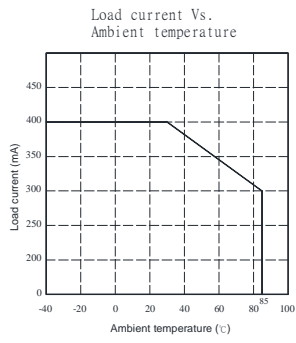

Taping Specifications for Surface Mount Devices

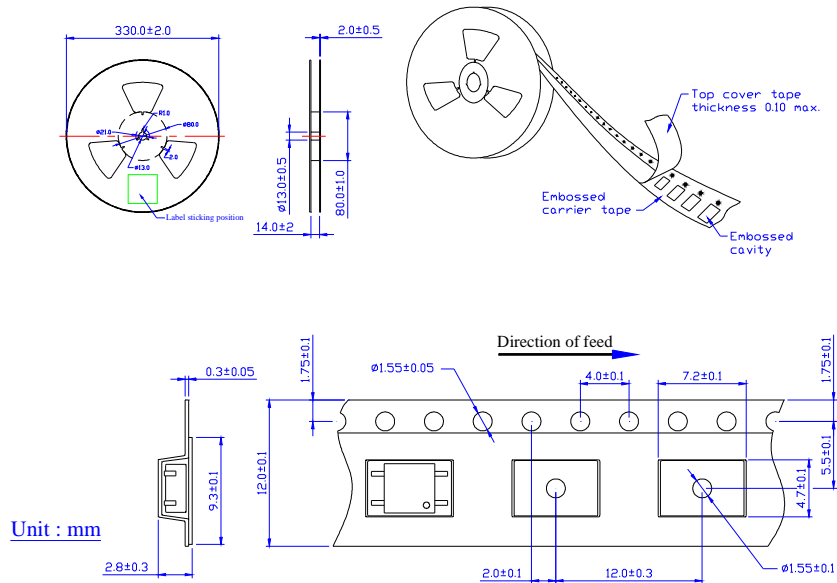

Recommended Mounting Pad

(Top view)

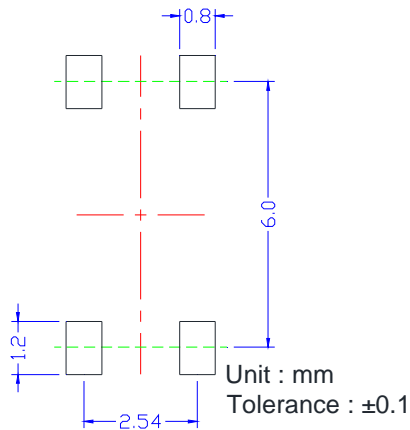

Marking

(Each photo MOS Relay shall be marked with the following information)

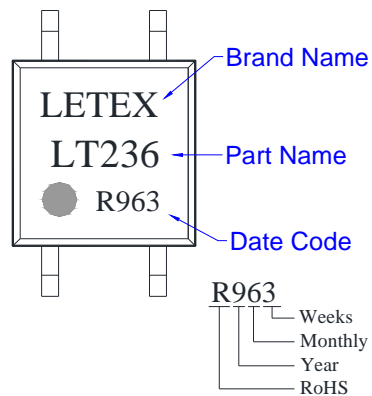

- Note: 1. There shall be leader of 230 mm minimum which may consist of carrier and or cover tape follower by a minimum of 160 mm of carrier tape sealed with cover tape.
2. There shall be a minimum of 160 mm of empty component pockets sealed with cover tape.
3. Devices are pockets in accordance with EIA standard EIA-481-A and specifications given above.
4. Packaging: 2,000pcs per reel, 2 reel per box, 5 boxes per carton.

X-ON Electronics

Largest Supplier of Electrical and Electronic Components

Click to view similar products for Solid State Relays - PCB Mount category:

Click to view products by Letex Technology manufacturer:

Other Similar products are found below :

[M86F-2W](#) [M90F-2W](#) [M90F-2Y](#) [901-SX](#) [G2-1A07-ST](#) [G2-1A07-TT](#) [G2-1B02-TT](#) [G2-DA06-ST](#) [PLA134S](#) [DS11-1005](#) [AQH3213J](#)
[AQV210EHJ](#) [AQV212J](#) [AQV252GAJ](#) [AQV258AJ](#) [AQY210ST](#) [AQY221N2SJ](#) [AQY221R2SJ](#) [EFR1200480A150](#) [901-7](#) [LCA220](#) [LCB110S](#)
[1618400-5](#) [SR75-1ST](#) [AQV112KLJ](#) [AQV212AJ](#) [AQV238AD01](#) [AQV252GAXJ](#) [AQW414TS](#) [AQY212ST](#) [AQY275AXJ](#) [AQY414SXE01](#)
[G2-1A02-ST](#) [G2-1A03-ST](#) [G2-1A03-TT](#) [G2-1A05-ST](#) [G2-1A06-TT](#) [G2-1A23-TT](#) [G2-1B01-ST](#) [G2-1B01-TT](#) [G2-1B02-ST](#) [G2-DA03-ST](#)
[G2-DA03-TT](#) [G2-DA06-TT](#) [3-1617776-2](#) [CTA2425](#) [TLP3131\(F\)](#) [LBA110S](#) [LBB110S](#) [LCA110LSTR](#)