

## PHOTOVOLTAIC MOSFET DRIVER

### Features

- SOP package 4 Pin type in miniature design (4.4×4.3×2.0mm / .173×.169×.083inch)
- High-speed switching
- 2500Vrms Input/Output isolation
- Tape & Reel version available

### Applications

- MOSFET driver  
Power supply (Vcc) for electronic circuits

### Outline Dimensions

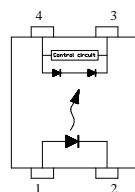
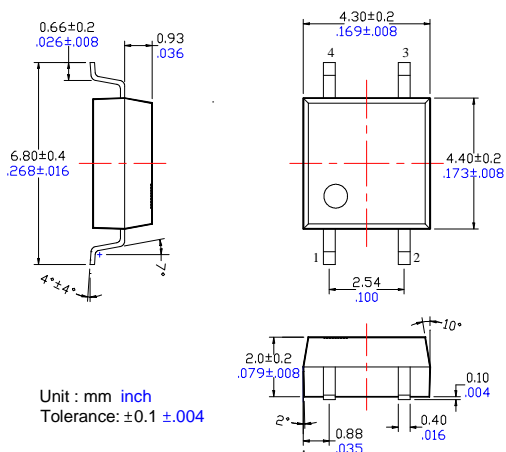

1. LED Anode
2. LED Cathode
3. Cathode
4. Anode

**PHOTOVOLTAIC MOSFET DRIVER****Part Name: LTP-1G2**

## Absolute Maximum Ratings (Ambient Temperature: 25°C)

Item	Symbol	Value	Units	Note	
Input	Continuous LED Current	I <sub>F</sub>	50	mA	
	Peak LED Current	I <sub>FP</sub>	1000	mA	f=100Hz, duty=1%
	LED Reverse Voltage	V <sub>R</sub>	5	V	
	Input Power Dissipation	P <sub>In</sub>	75	mW	
I/O Breakdown Voltage	V <sub>I/O</sub>	2500	V <sub>rms</sub>	RH=60%, 1min	
Operating Temperature	T <sub>Opr</sub>	-40 to +85	°C		
Storage Temperature	T <sub>Stg</sub>	-40 to +100	°C		

## Electrical Specifications (Ambient Temperature: 25°C)

Item	Symbol	MIN.	TYP.	MAX.	Units	Conditions
Input	LED Forward Voltage	V <sub>F</sub>	1.2	1.4	V	I <sub>F</sub> =10mA
	Operation LED Current	I <sub>F On</sub>	0.5	3.0	mA	V <sub>oc</sub> =5V
	Recovery LED Current	I <sub>F Off</sub>	0.35	0.5	mA	V <sub>oc</sub> =1V
Output	Drop-out Voltage	V <sub>cc</sub>	6	8	V	I <sub>F</sub> =10mA
	Short Circuit Current	I <sub>sc</sub>	3	8	uA	I <sub>F</sub> =10mA
Transmis sion	Turn-On Time	T <sub>On</sub>	0.23		ms	I <sub>F</sub> =10mA
	Turn-Off Time	T <sub>of</sub>	0.03		ms	C <sub>L</sub> =1000pF
Coupled	I/O Isolation Resistance	R <sub>I/O</sub>	10 <sup>10</sup>		Ω	DC500V
	I/O Capacitance	C <sub>I/O</sub>	0.8	1.5	pF	f=1MHz

# Reference Data

Drop-out voltage Vs. Ambient temperature

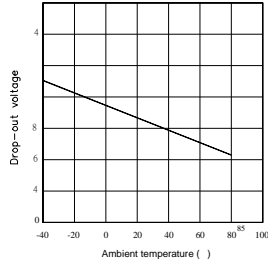

Shotr circuit current Vs. Ambient temperature

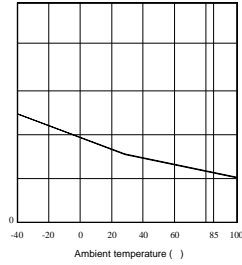

Turn on time Vs. Ambient temperature

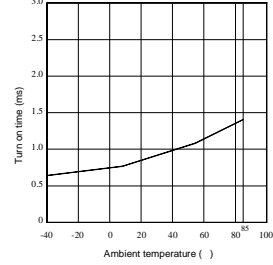

Turn off time Vs. Ambient temperature

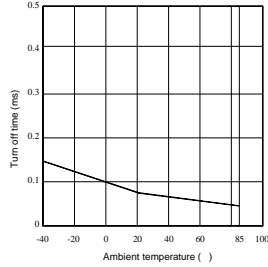

LED operate current Vs. Ambient temperature

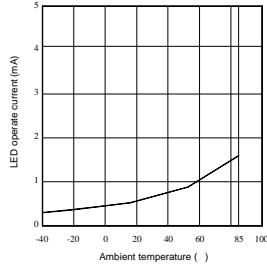

LED turn off current Vs. Ambient temperature

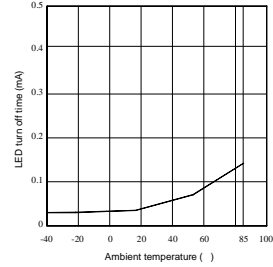

LED dropout voltage Vs. Ambient temperature

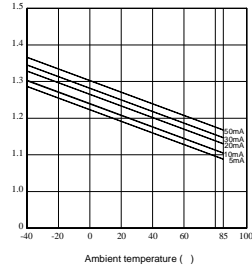

Turn on time Vs. Forward current characteristics

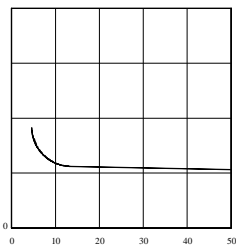

Turn off time Vs. LED forward current characteristics

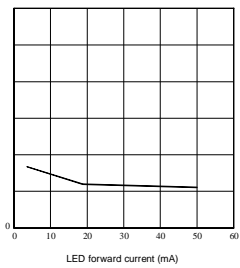

## Taping Specifications for Surface Mount Devices

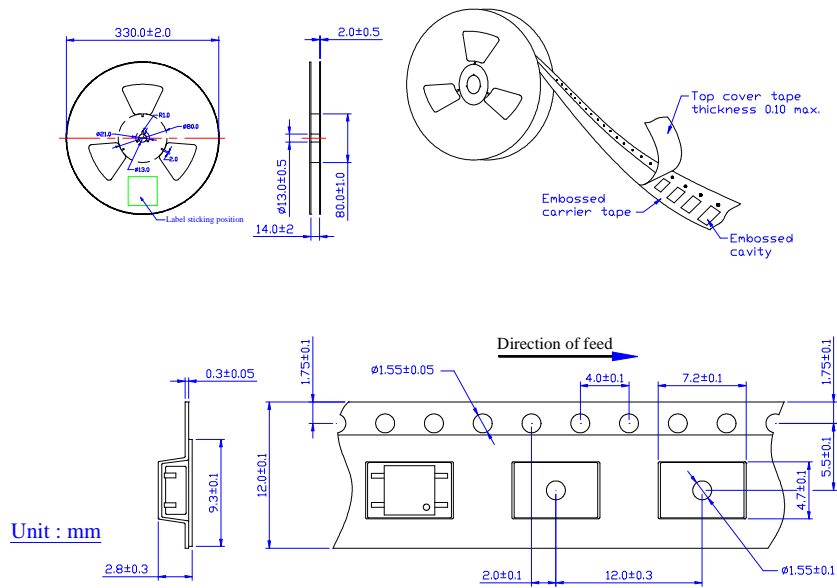

### Recommended Mounting Pad

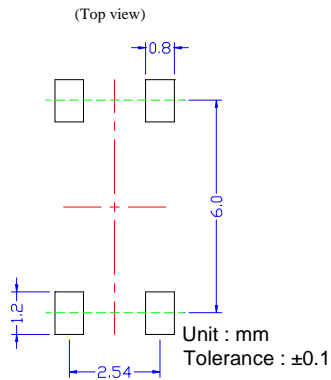

### Marking

(Each photo MOS Relay shall be marked with the following information)

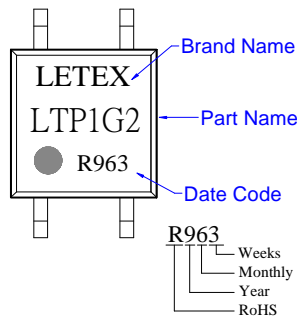

- Note: 1. There shall be leader of 230 mm minimum which may consist of carrier and or cover tape follower by a minimum of 160 mm of carrier tape sealed with cover tape.
2. There shall be a minimum of 160 mm of empty component pockets sealed with cover tape.
3. Devices are pockets in accordance with EIA standard EIA-481-A and specifications given above.
4. Packaging: 2,000pcs per reel, 2 reel per box, 5 boxes per carton.

## X-ON Electronics

Largest Supplier of Electrical and Electronic Components

*Click to view similar products for [Transistor Output Optocouplers](#) category:*

*Click to view products by [Letex Technology](#) manufacturer:*

Other Similar products are found below :

[LTV-814S-TA](#) [LTV-852S](#) [66095-001](#) [PS2561-1-A](#) [PS2561A-1-W-A](#) [PS2561L1-1-A](#) [PS2561L-1-V-A](#) [PS2706-1-A](#) [PS2815-1-A](#) [MRF658](#)  
[ELD207\(TA\)](#) [ILD2-X006](#) [ILQ615-3X016](#) [LDA102S](#) [SFH615A-4XSM TR](#) [PS2561DL-1Y-F3-A](#) [PS2561L1-1-L-A](#) [PS2562-1-V-A](#) [PS2565L-](#)  
[1-A](#) [PS2581L2-A](#) [PS2701A-1-F3-P-A](#) [PS2711-1-A](#) [PS2801-1-F3-P-A](#) [PS2833-4-A](#) [PS2841-4A-AX](#) [LTV-702FS](#) [LTV-702V](#) [LTV-702VB](#)  
[LTV-816S-TA](#) [TCET2100](#) [TLP290-4\(E\(T](#) [IL215AT](#) [WPPC-A11066AA](#) [WPPC-A11066AD](#) [WPPC-A11084ASS](#) [WPPC-A21068AA](#) [WPPC-](#)  
[D11066AA](#) [WPPC-D21068ED](#) [WPPC-D410616EA](#) [WPPC-D410616ED](#) [X4IAC24A](#) [4N26-X001](#) [EL1010\(TA\)-VG](#) [SFH600-2X007](#)  
[TCMT1118](#) [VO206AT](#) [WPPC-D21068EA](#) [WPPC-D11064AD](#) [WPPC-A410616AD](#) [WPPC-A21068AD](#)