

GENERAL DESCRIPTION

The LW52XX Series is a group of voltage regulators with high accuracy, high speed, low drop-out, high ripple rejection and fast discharge function.

The current limiter's fold-back circuit operates as a short circuit protection as well as the output current limiter for the output pin.

Output voltage is selectable from 0.8V to 5.0V which fixed by laser trimming technologies, Step=100mV.

The LW52XX Series is available in SOT23, SOT23-3L, SOT23-5L and DFN1x1-4L packages.

FEATURES

- Output Accuracy: $\pm 1.5\%$
- Low Quiescent Current: 40uA
- Low Dropout Voltage: 42mV@100mA/3.3V
- High PSRR: 95dB@1KHz, 1mA
- Output Current: 500mA
- Excellent Line and Load Transient Response
- Operating Voltage Range: from 1.5V to 6.0V
- Output Voltage Range: from 0.8V to 5.0V
- Over-Temperature Protection
- Current Limiting Protection
- Output Short-Circuit Protection
- Available in SOT23, SOT23-3L, SOT23-5L and DFN1x1-4L Packages

APPLICATIONS

- Battery-Powered Devices
- Reference Voltage Sources
- Other Low Voltage Power Suppliers

TYPICAL APPLICATION CIRCUIT

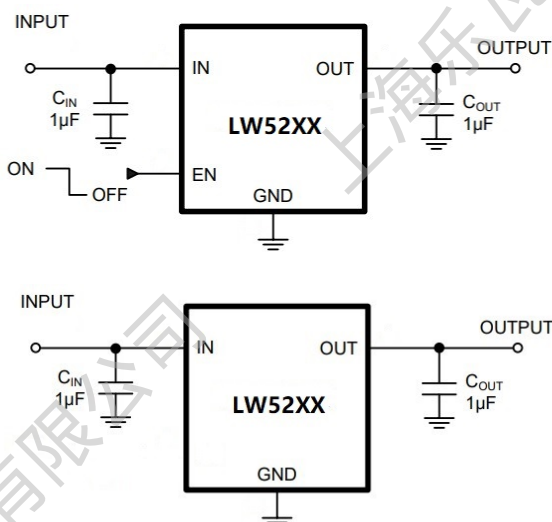

TYPICAL PERFORMANCE CHARACTERISTICS

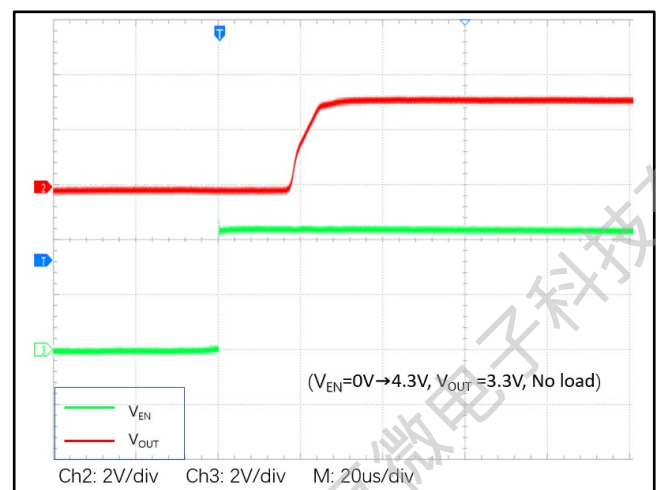

PIN DESCRIPTION:

PIN No				SYMBOL	DESCRIPTION
SOT23	SOT23-3L	SOT23-5L	DFN1x1-4L		
3	3	1	4	VIN	Power Supply Input
1	1	2	2,E-PAD	GND	Ground
--	--	3	3	EN	Chip Enable
--	--	4	--	NC	Not Connected
2	2	5	1	VOUT	Output

PIN ASSIGNMENT

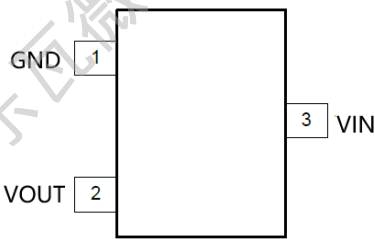

SOT23/SOT23-3L

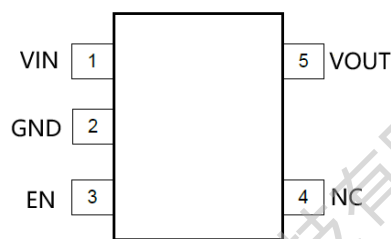

SOT23-5L

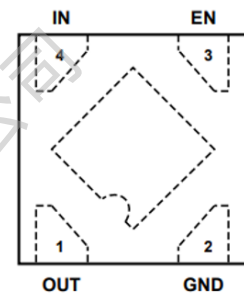

DFN1x1-4L

MARK INFORMATION:

SOT23

XX: VOLTAGE

YY: DATE CODE

52XXYY

SOT23-3/5L

XX: VOLTAGE

YY: DATE CODE

LW52XX
• YYYYY

DFN1x1-4L

X: VOLTAGE

52X

0.8V	0.9V	1.0V	1.2V	1.5V	1.8V	2.5V	2.8V	3.0V	3.3V	3.6V	4.2V	5.0V
A	R	B	C	D	G	H	J	L	M	P	S	T

ABSOLUTE MAXIMUM RATINGS ⁽¹⁾:

(T_A =25°C, unless otherwise specified.)

SYMBOL	ITEM	RATING	UNIT
V _{IN}	Supply Voltage	-0.3~7.0	V
V _{EN}	EN Pin Voltage	-0.3~7.0	V
V _{OUT}	VOUT pin Voltage	-0.3~(V _{IN} +0.3)	V
V _(ESD)	ESD Susceptibility, HBM ⁽²⁾	±4000	V
PD	Maximum Power Dissipation	SOT23	285
		SOT23-3/5L	450
		DFN1x1-4L	350
PTR	Package Thermal Resistance Θ _{JA}	SOT23	350
		SOT23-3/5L	220
		DFN1x1-4L	280
T _J	Junction Temperature Range	-40~150	°C
T _{STG}	Storage Temperature Range	-40~150	°C
T _{SOLDER}	Lead Temperature (Soldering)	260°C, 10s	

Note:

1. Stresses beyond those listed under Absolute Maximum Ratings may cause permanent damage to the device. These are stress ratings only, and functional operation of the device at these or any other conditions beyond those indicated under Recommended Operating Conditions is not implied. Exposure to absolute-maximum-rated conditions for extended periods may affect device reliability

2: per ANSI/ESDA/JEDEC JS-001

RECOMMENDED OPERATING RANGE:

SYMBOL	ITEM	VALUE	UNIT
V _{IN}	VIN Supply Voltage	1.5~6.0	V
V _{EN}	EN Pin Voltage	0~6.0	V
V _{OUT}	VOUT Pin Voltage	0.8~5.0	V
I _{OUT}	Output Current	0~500	mA
T _J	Junction Temperature Range	-40~125	°C

ELECTRICAL CHARACTERISTICS:

($V_{IN}=V_{OUT}+1V$, $V_{OUT}=3.3V$, $C_{IN}=C_{OUT}=1\mu F$, $T_A=25^\circ C$, unless otherwise specified.)

Symbol	Parameter	Conditions	MIN	TYP	MAX	Units	
V_{IN}	Input Voltage		1.5		6.0	V	
V_{OUT}	Output Accuracy	$I_{OUT}=1mA$	-1.5		+1.5	%	
I_{LIM}	Current Limit ⁽¹⁾	$V_{IN}=4.3V$, $V_{OUT}=3.3V$	515	700		mA	
I_Q	Quiescent Current	$V_{IN}=V_{EN}=V_{OUT}+1V$, No Load		40	60	μA	
I_{SHD}	Shutdown Current	$V_{IN}=6.0V$, $V_{EN}=0V$			0.1	μA	
V_{DROP}	Dropout Voltage ⁽²⁾	$I_{OUT}=100mA$, $V_{OUT}=3.3V$		42		mV	
		$I_{OUT}=300mA$, $V_{OUT}=3.3V$		130			
		$I_{OUT}=500mA$, $V_{OUT}=3.3V$		230			
S_{LINE}	Line Regulation	$V_{IN}=V_{OUT}+1V$ to 6.0V, $I_{OUT}=1mA$	$V_{OUT}>0.9V$		0.06	0.13	%/V
			$V_{OUT}\leq 0.9V$		15	20	mV
S_{LOAD}	Load Regulation	$1mA\leq I_{OUT}\leq 500mA$		0.001	0.01	%/mA	
I_{SHORT}	Short Current	$V_{OUT}=0V$		100		mA	
V_{ENH}	EN High Voltage	$V_{IN}=1.5V$ to 6.0V, $I_{OUT}=1mA$	1.5			V	
V_{ENL}	EN Low Voltage				0.5	V	
T_{STR}	Startup Time	From V_{EN} 'L' \rightarrow 'H' to 95%* V_{OUT} , $C_{OUT}=1\mu F$, No Load		25		μs	
PSRR	Power Supply Rejection Ratio	$C_{IN}=None$, $V_{OUT}=3.3V$, $I_{OUT}=1mA$	$f=217Hz$		93		dB
			$f=1KHz$		95		
			$f=10KHz$		73		
T_{SD}	Thermal Shut Down	Temperature rising		155		$^\circ C$	
ΔT_{SD}	TSD Hysteresis	Temperature falling		20		$^\circ C$	
$R_{DISCHRG}$	R_{ON} of Discharge MOSFET	$V_{IN}=6V$, $V_{EN}=0V$		200		Ω	

NOTES:

1. Guaranteed by design
2. The dropout voltage is defined as $V_{IN} - V_{OUT}$, when $V_{OUT}=95\%*V_{OUT(NOM)}$

SIMPLIFIED BLOCK DIAGRAM:

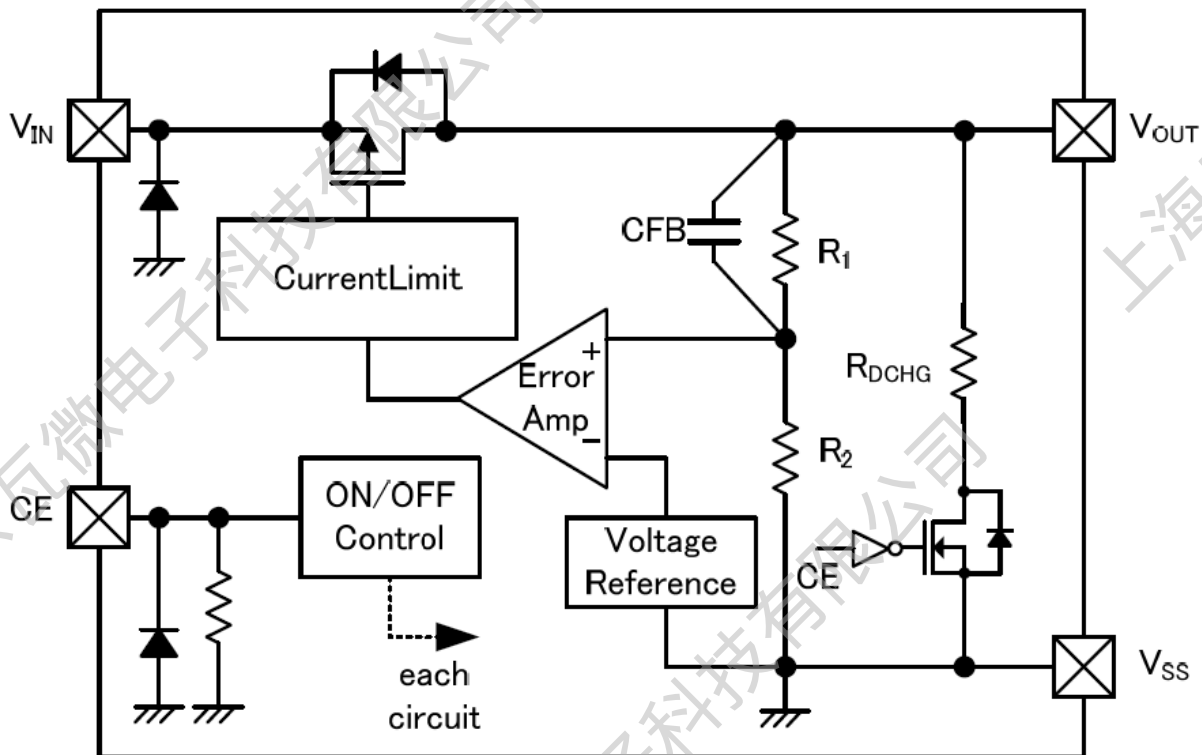

DETAIL OPERATION DESCRIPTION:

The LW52XX Series is a low power consumption low drop-out voltage regulator. It consists of a current limiter circuit, a driver transistor, a precision voltage reference and an error correction circuit, and is compatible with low ESR ceramic capacitors. The current limiter's fold-back circuit operates as a short circuit protection as well as the output current limiter.

Current Limiting and Short-Circuit Protection

The current limit circuitry prevents damage to the MOSFET switch and the hub downstream port but can deliver load current up to the current limit threshold through the switch. When a heavy load or short circuit is applied to an enabled switch, a large transient current may flow until the current limit circuitry responds. Once this current limit threshold is exceeded the device enters constant current mode until the thermal shutdown occurs or the fault is removed.

TYPICAL OPERATING CHARACTERISTICS:

(Tested under $T_A = 25^\circ\text{C}$, unless otherwise specified)

1. V_{OUT} vs Temperature

($V_{IN}=4.3\text{V}$, $V_{OUT}=3.3\text{V}$, $I_{OUT}=10\text{mA}$)

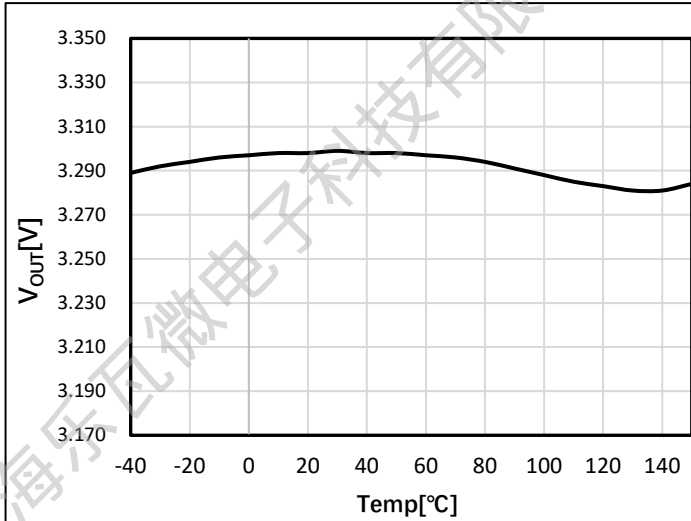

2. I_Q vs V_{IN}

($V_{OUT}=3.3\text{V}$, $I_{OUT}=0\text{mA}$)

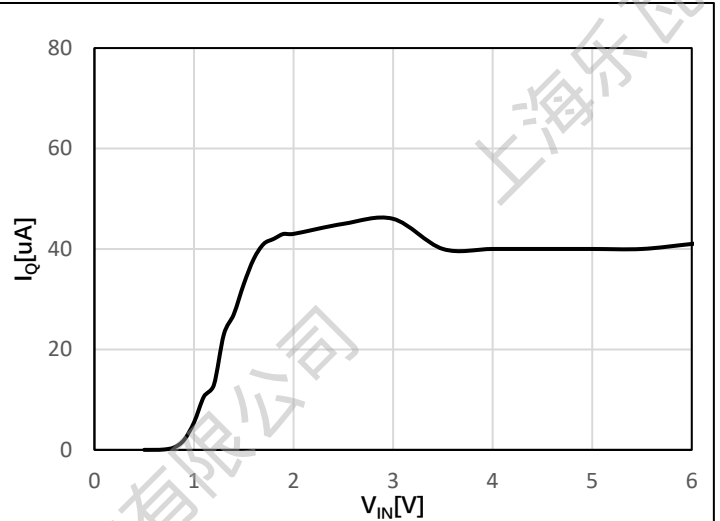

3. V_{OUT} vs I_{OUT}

($V_{IN}=4.3\text{V}$, $V_{OUT}=3.3\text{V}$, $I_{OUT}=0 \rightarrow 500\text{mA}$)

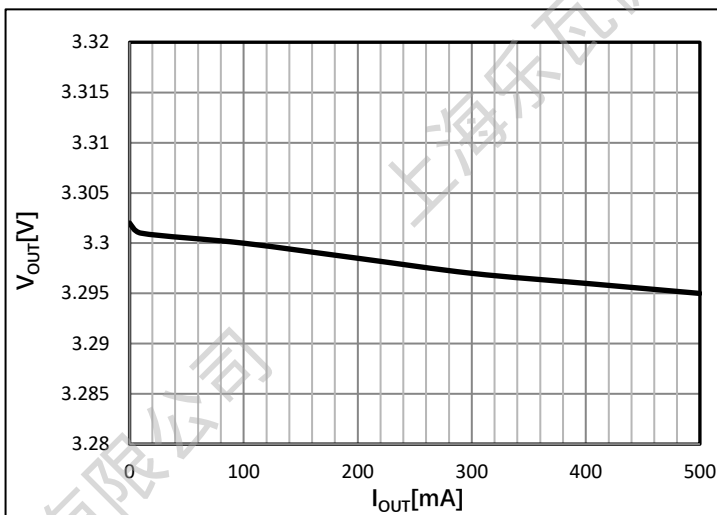

4. V_{OUT} vs V_{IN}

($V_{IN}=3.8\text{V} \rightarrow 6.5\text{V}$, $V_{OUT}=3.3\text{V}$, $I_{OUT}=1\text{mA}$)

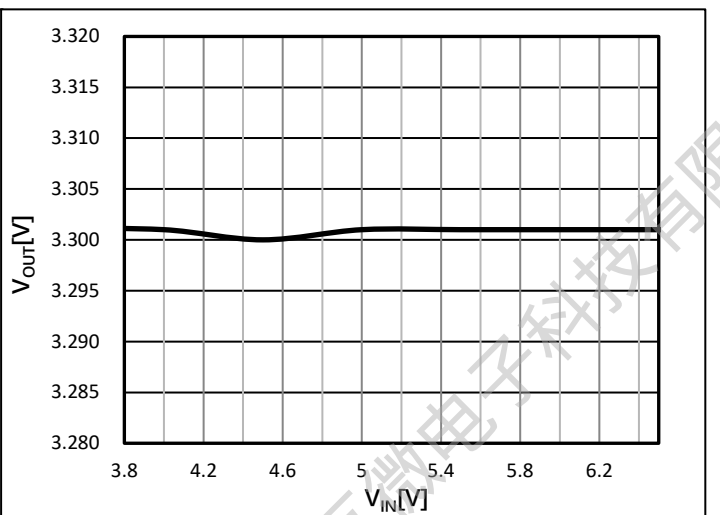

5. Dropout Voltage
($V_{OUT} = 95\% \times 3.3V$, $I_{OUT} = 0 \rightarrow 500mA$)

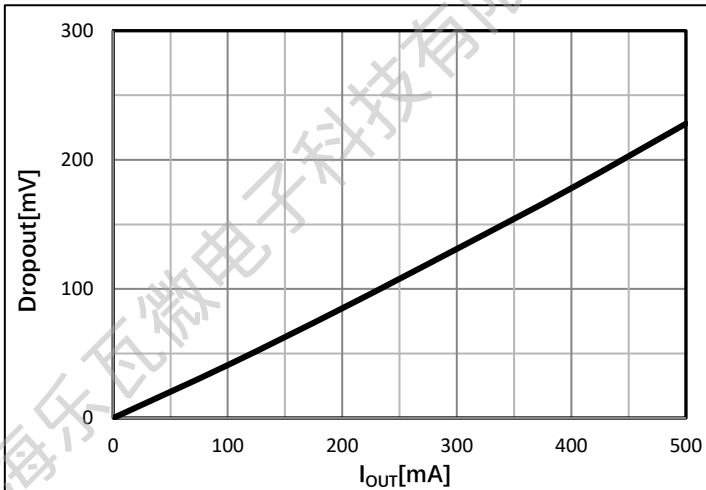

6. V_{EN} Thresholds vs V_{IN}
($V_{OUT} = 3.3V$, $I_{OUT} = 0mA$)

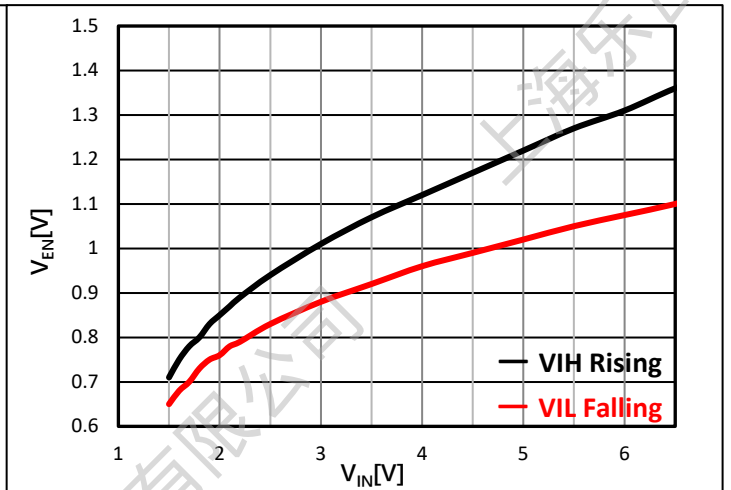

7. Line Transient
($V_{IN} = 4.3V \rightarrow 6.0V$, $V_{OUT} = 3.3V$, $I_{OUT} = 1mA$)

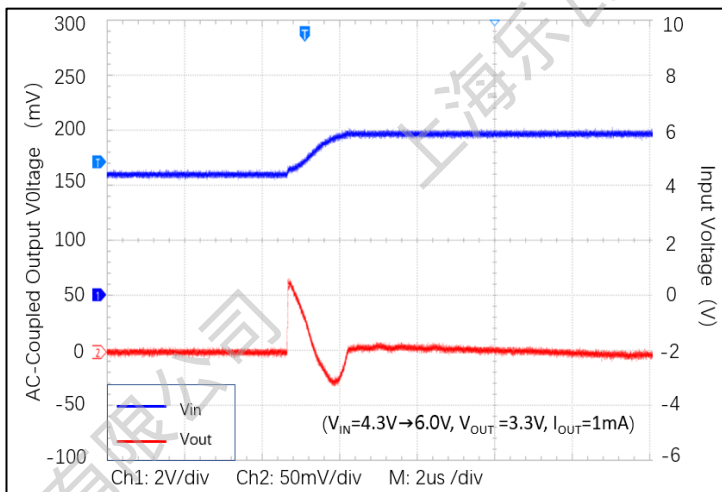

8. Load Transient
($V_{IN} = 4.3V$, $V_{OUT} = 3.3V$, $I_{OUT} = 1 \rightarrow 500mA$)

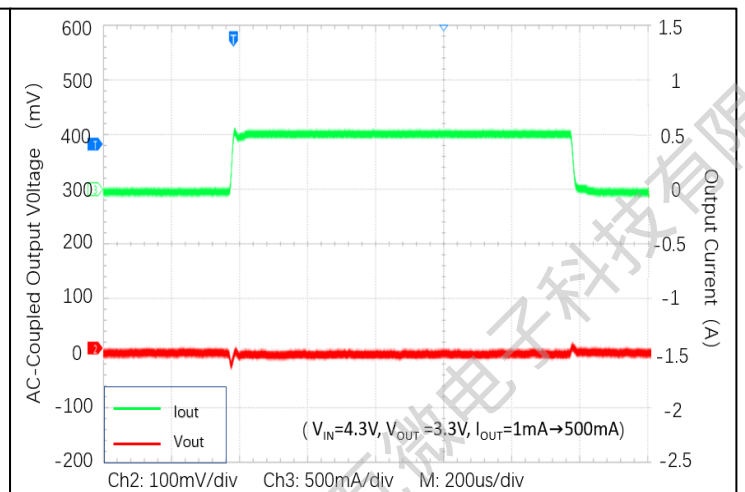

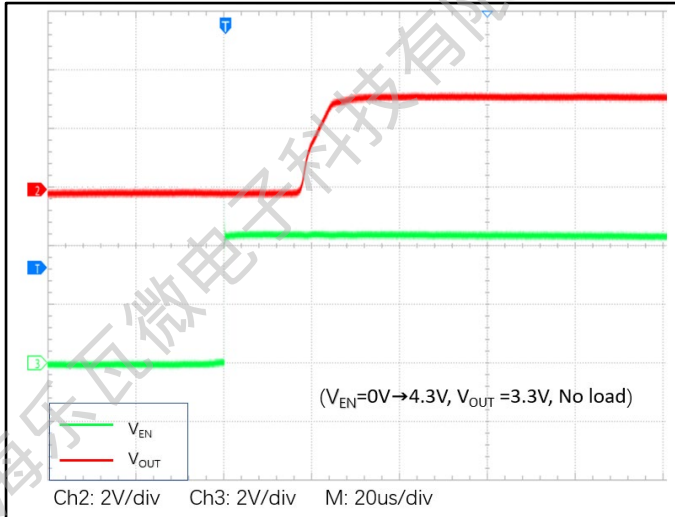
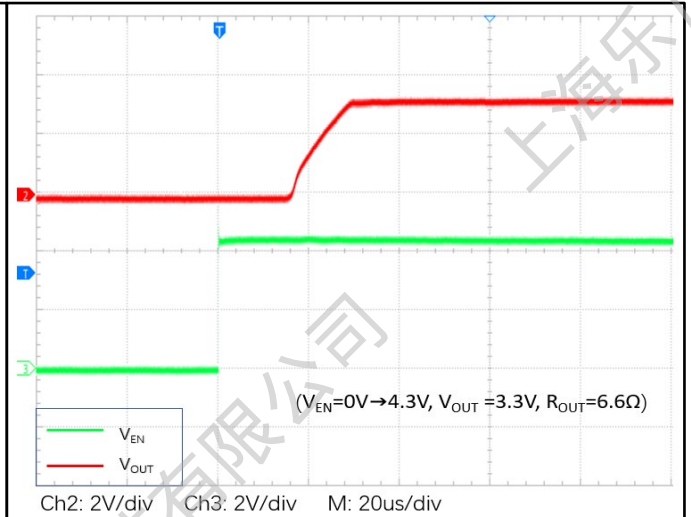
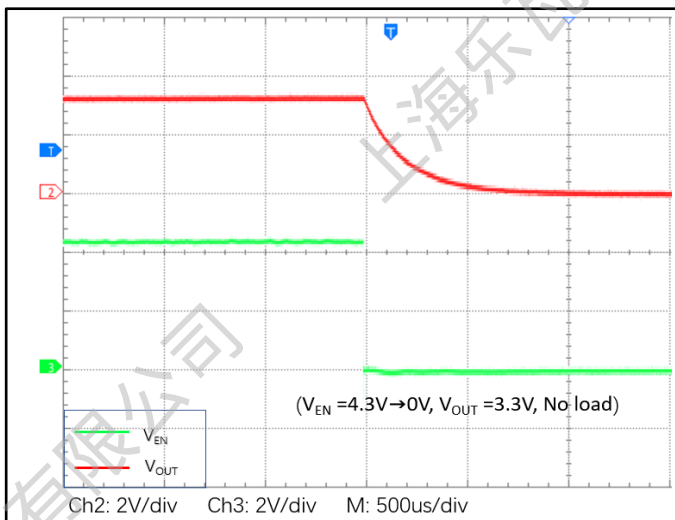
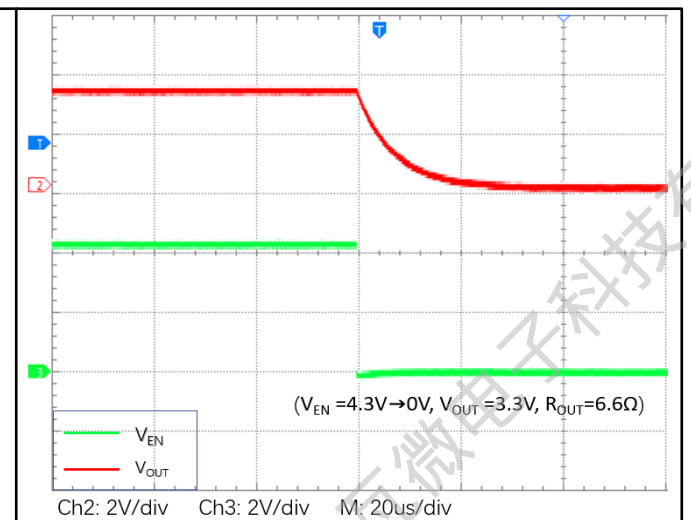
9. Start-Up
 $(V_{EN}=0V \rightarrow 4.3V, V_{IN}=4.3V, V_{OUT}=3.3V, \text{No Load})$

10. Start-Up
 $(V_{EN}=0V \rightarrow 4.3V, V_{IN}=4.3V, V_{OUT}=3.3V, R_{OUT}=6.6\Omega)$

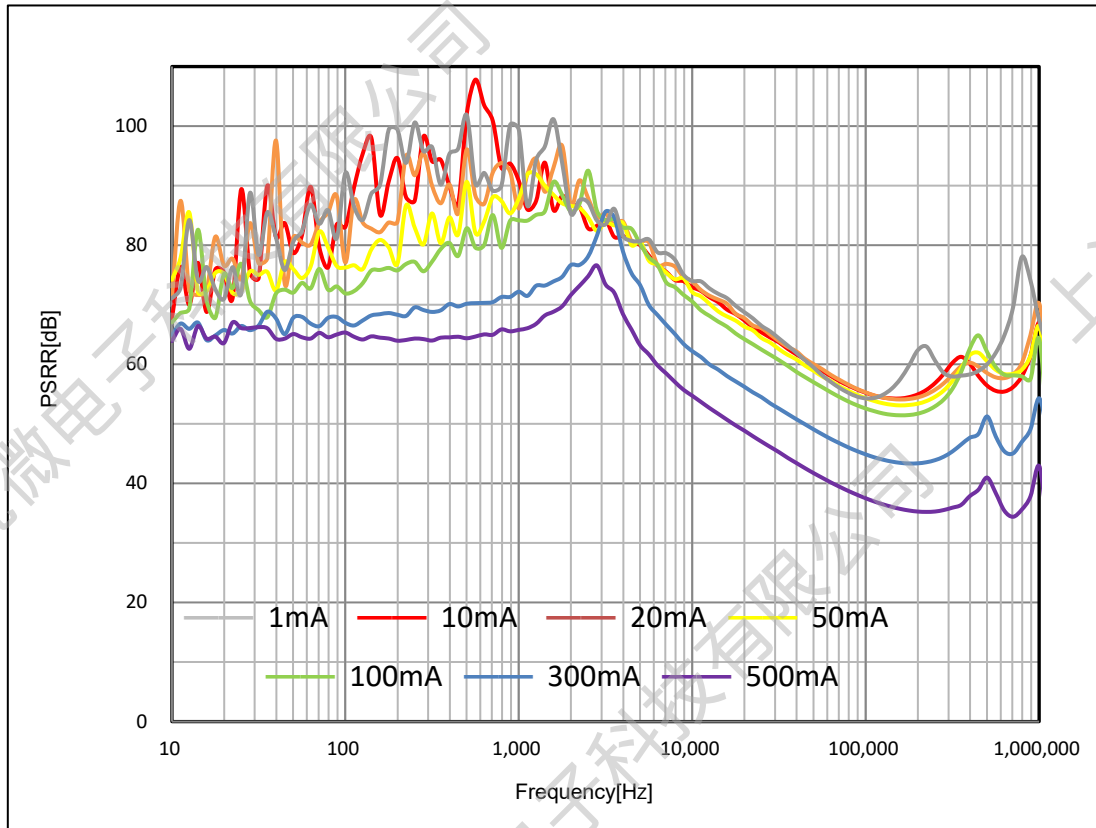
11. Shut-Down
 $(V_{EN}=4.3V \rightarrow 0V, V_{IN}=4.3V, V_{OUT}=3.3V, \text{No Load})$

12. Shut-Down
 $(V_{EN}=4.3V \rightarrow 0V, V_{IN}=4.3V, V_{OUT}=3.3V, R_{OUT}=6.6\Omega)$

13. PSRR

 $(V_{IN}=4.3V, V_{OUT}=3.3V, V_{PP}=1.0V, C_{IN}=none, C_{OUT}=1\mu F)$ 

APPLICATION INFORMATION:**● Input Capacitor Selection**

Like any low-dropout regulator, the external capacitors used with the LW52XX Series must be carefully selected for regulator stability and performance. Using a capacitor whose value is $\geq 1\mu\text{F}$ on the LW52XX Series input and the amount of capacitance can be increased without limit. An at least $10\mu\text{F}$ input capacitor is needed if input ripple voltage $V_{pp} > 1\text{V}$. The input capacitor must be located a distance less than 0.5 inch from the input pin of the IC and returned to a clean analog ground. Any good quality ceramic or tantalum can be used for this capacitor. The capacitor with larger value and lower ESR (equivalent series resistance) provides better PSRR and line-transient response.

● Layout considerations

To improve ac performance such as PSRR, output noise, and transient response, it is recommended that the PCB be designed with separate ground planes for VIN and VOUT, with each ground plane connected only at the GND pin of the device.

● Output Capacitor Selection

The output capacitor must meet both requirements for minimum amount of capacitance and ESR in all LDOs application. The LW52XX Series is designed specifically to work with low ESR ceramic output capacitor in space-saving and performance consideration. Using a ceramic capacitor whose value is at least $1\mu\text{F}$ on the LW52XX Series output ensures stability. An appropriate output capacitor can reduce noise and improve load transient response and PSRR. The output capacitor should be located not more than 0.5 inch from the VOUT pin of the LW52XX Series and returned to a clean analog ground.

ORDER INFORMATION:

LW52①②③④⑤⑥

Designator	Item	Symbol	Description
①②	Output Voltage	08~50	e.g.0.8V→①=0,②=8
③④⑤⑥	Packages	N23C	SOT23
		N23D	SOT23-3L
		A23E	SOT23-5L
		N11E	DFN1x1-4L

Part #	Output Voltage	Package	Shipping
LW5208N23C	0.8V	SOT23	3000 Pcs/ Tape & Reel
LW5209N23C	0.9V		
LW5210N23C	1.0V		
LW5212N23C	1.2V		
LW5215N23C	1.5V		
LW5218N23C	1.8V		
LW5222N23C	2.2V		
LW5225N23C	2.5V		
LW5228N23C	2.8V		
LW5230N23C	3.0V		
LW5233N23C	3.3V		
LW5236N23C	3.6V		
LW5242N23C	4.2V		
LW5250N23C	5.0V		
LW5208N23D	0.8V	SOT23-3L	3000 Pcs/ Tape & Reel
LW5209N23D	0.9V		
LW5210N23D	1.0V		
LW5212N23D	1.2V		
LW5215N23D	1.5V		
LW5218N23D	1.8V		
LW5222N23D	2.2V		
LW5225N23D	2.5V		
LW5228N23D	2.8V		
LW5230N23D	3.0V		
LW5233N23D	3.3V		
LW5236N23D	3.6V		
LW5242N23D	4.2V		
LW5250N23D	5.0V		

Part #	Output Voltage	Package	Shipping
LW5208A23E	0.8V	SOT23-5L	3000 Pcs/ Tape & Reel
LW5209A23E	0.9V		
LW5210A23E	1.0V		
LW5212A23E	1.2V		
LW5215A23E	1.5V		
LW5218A23E	1.8V		
LW5222A23E	2.2V		
LW5225A23E	2.5V		
LW5228A23E	2.8V		
LW5230A23E	3.0V		
LW5233A23E	3.3V		
LW5236A23E	3.6V		
LW5242A23E	4.2V		
LW5250A23E	5.0V		
LW5208N11E	0.8V	DFN1x1-4L	10000 Pcs/ Tape & Reel
LW5209N11E	0.9V		
LW5210N11E	1.0V		
LW5212N11E	1.2V		
LW5215N11E	1.5V		
LW5218N11E	1.8V		
LW5222N11E	2.2V		
LW5225N11E	2.5V		
LW5228N11E	2.8V		
LW5230N11E	3.0V		
LW5233N11E	3.3V		
LW5236N11E	3.6V		
LW5242N11E	4.2V		
LW5250N11E	5.0V		

If customers have special output voltage requirements, please contact us.

PACKAGE OUTLINE:

SOT23 Package

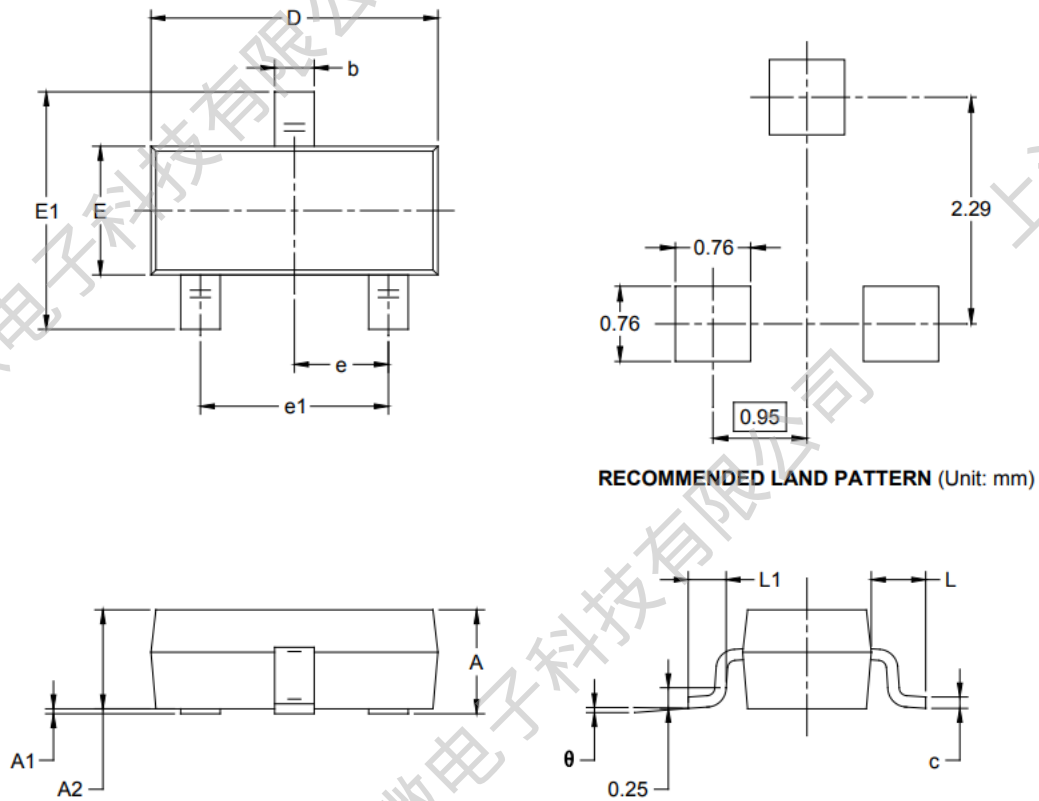

Symbol	Dimensions In Millimeters		Dimensions In Inches	
	MIN	MAX	MIN	MAX
A	0.900	1.150	0.035	0.045
A1	0.000	0.100	0.000	0.004
A2	0.900	1.050	0.035	0.041
b	0.300	0.500	0.012	0.020
c	0.080	0.150	0.003	0.006
D	2.800	3.000	0.110	0.118
E	1.200	1.400	0.047	0.055
E1	2.250	2.550	0.089	0.100
e	0.950 BSC		0.037 BSC	
e1	1.900 BSC		0.075 BSC	
L	0.550 REF		0.022 REF	
L1	0.300	0.500	0.012	0.020
θ	0°	8°	0°	8°

SOT23-3L Package

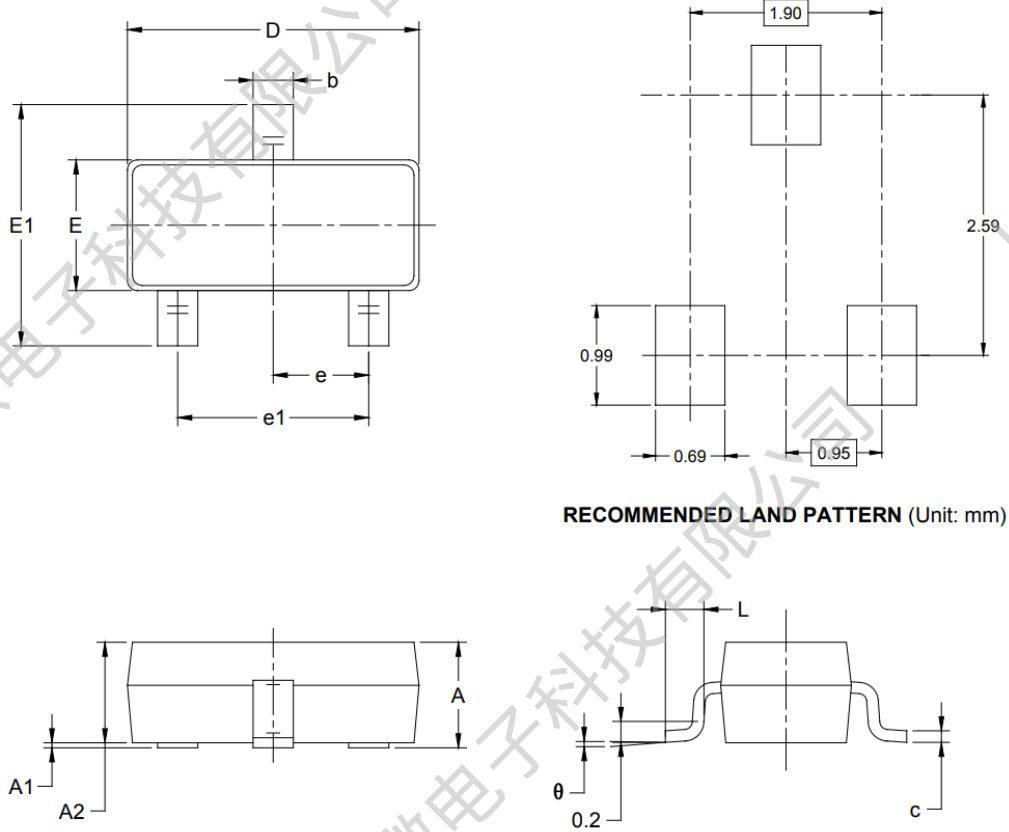

Symbol	Dimensions In Millimeters		Dimensions In Inches	
	MIN	MAX	MIN	MAX
A	1.050	1.250	0.041	0.049
A1	0.000	0.100	0.000	0.004
A2	1.050	1.150	0.041	0.045
b	0.300	0.500	0.012	0.020
c	0.100	0.200	0.004	0.008
D	2.820	3.020	0.111	0.119
E	1.500	1.700	0.059	0.067
E1	2.650	2.950	0.104	0.116
e	0.950 BSC		0.037 BSC	
e1	1.900 BSC		0.075 BSC	
L	0.300	0.600	0.012	0.024
θ	0°	8°	0°	8°

SOT23-5L Package

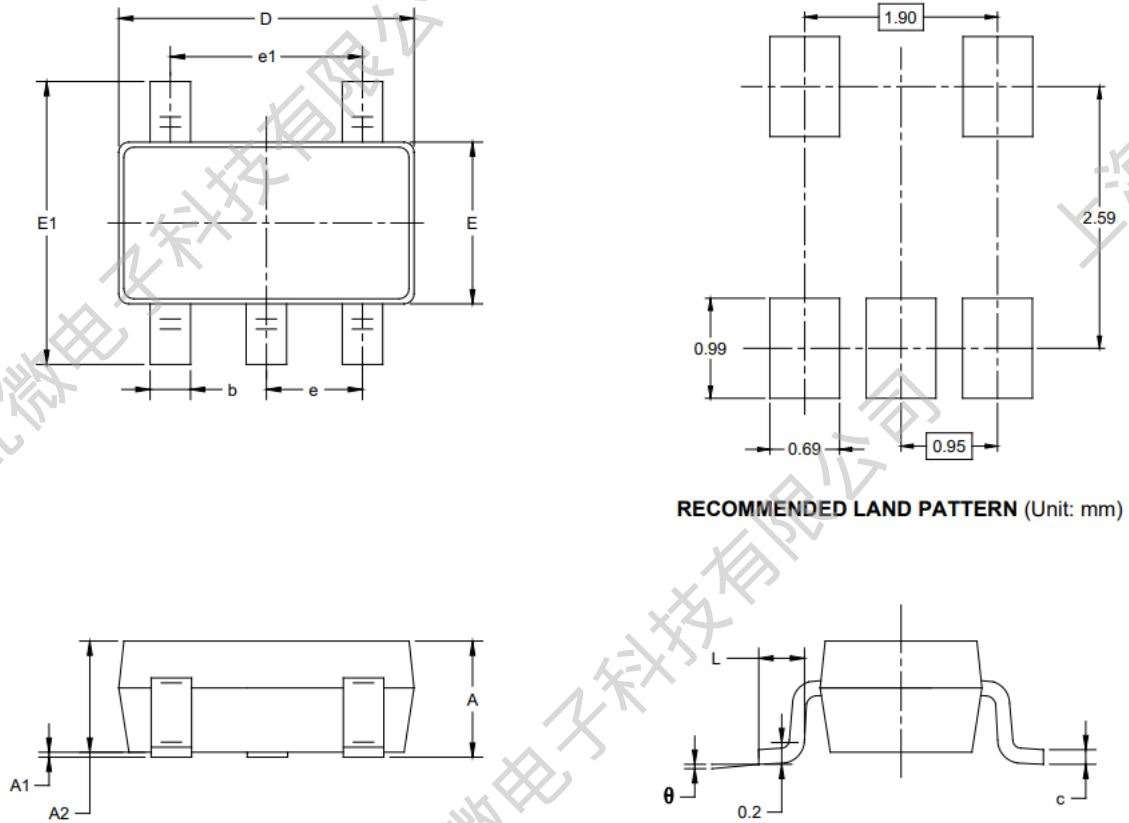

Symbol	Dimensions In Millimeters		Dimensions In Inches	
	MIN	MAX	MIN	MAX
A	1.050	1.250	0.041	0.049
A1	0.000	0.100	0.000	0.004
A2	1.050	1.150	0.041	0.045
b	0.300	0.500	0.012	0.020
c	0.100	0.200	0.004	0.008
D	2.820	3.020	0.111	0.119
E	1.500	1.700	0.059	0.067
E1	2.650	2.950	0.104	0.116
e	0.950 BSC		0.037 BSC	
e1	1.900 BSC		0.075 BSC	
L	0.300	0.600	0.012	0.024
θ	0°	8°	0°	8°

DFN1x1-4L Package

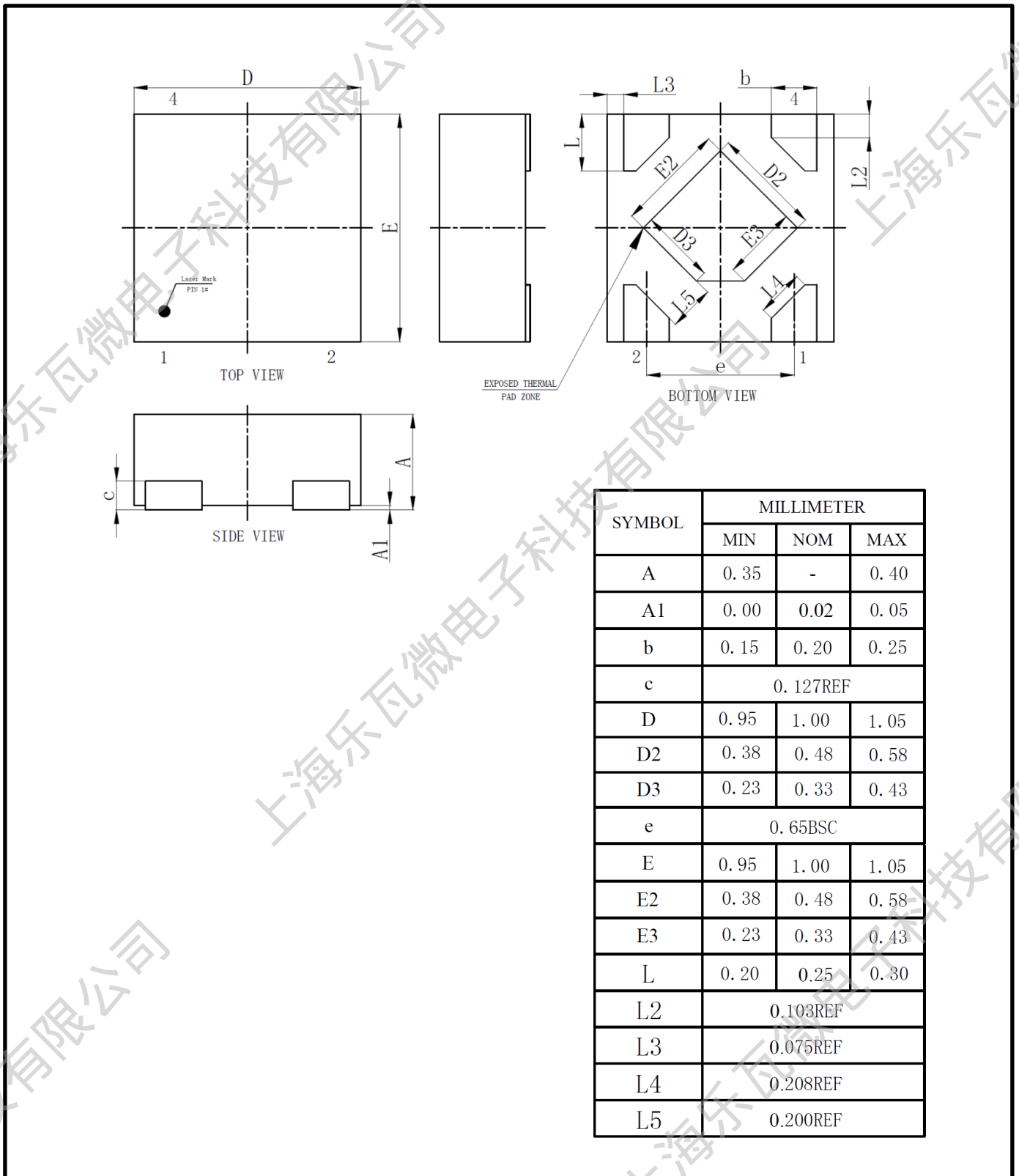

Revision History:

Revision	Date	Descriptions
Rev 0.1	Oct.2021	Initial Version
Rev 0.2	Jan.2022	Update Feature and Electrical Characteristics
Rev 0.3	Mar.2022	Update Feature and Electrical Characteristics
Rev 0.4	May.2022	Define package type
Rev 1.0	Jun.2022	Formal Version
Rev 1.1	Aug.2022	Add Test Condition for Typical Operating Characteristics 13
Rev 1.2	Sep.2022	Adjust Order Information
Rev 1.3	Apr. 2023	Add TSD hysteresis in EC Table
Rev 1.4	Jun. 2023	Modify Typical Operating Characteristcs 9-12

DISCLAIMER:

The information in this document is believed to be accurate and reliable. However, no responsibility is assumed by LW-Micro for its use. All operating parameters must be designed, validated and tested to ensure they meet the requirements of your application. LW-Micro reserves the right to make any specification and/or circuitry changes without prior notification. Before starting a brand-new project, please contact LW-Micro Sales to get the most recent relevant information.

Mailing Address: Room 301, Building 2, No.1690 CaiLun Road, China (Shanghai) Pilot Free Trade Zone
Shanghai Lewa Micro-electronics Technology Co., Ltd

X-ON Electronics

Largest Supplier of Electrical and Electronic Components

Click to view similar products for [LDO Voltage Regulators](#) category:

Click to view products by [Lewa Micro](#) manufacturer:

Other Similar products are found below :

[AP7363-SP-13](#) [NCV8664CST33T3G](#) [L79M05TL-E](#) [AP7362-HA-7](#) [PT7M8202B12TA5EX](#) [TCR3DF185,LM\(CT](#) [TLF4949EJ](#)
[NCP4687DH15T1G](#) [NCV8703MX30TCG](#) [LP2951CN](#) [NCV4269CPD50R2G](#) [AP7315-25W5-7](#) [NCV47411PAAJR2G](#) [AP2111H-1.2TRG1](#)
[ZLDO1117QK50TC](#) [AZ1117ID-ADJTRG1](#) [NCV4263-2CPD50R2G](#) [NCP114BMX075TCG](#) [MC33269T-3.5G](#) [TLE4471GXT](#) [AP7315-33SA-](#)
[7](#) [NCV4266-2CST33T3G](#) [NCP715SQ15T2G](#) [NCV8623MN-50R2G](#) [NCV563SQ18T1G](#) [NCV8664CDT33RKG](#) [NCV4299CD250R2G](#)
[NCP715MX30TBG](#) [NCV8702MX25TCG](#) [L974113TR](#) [TLE7270-2E](#) [NCV562SQ25T1G](#) [AP2213D-3.3TRG1](#) [AP2202K-2.6TRE1](#)
[NCV8170BMX300TCG](#) [NCV8152MX300180TCG](#) [NCP700CMT45TBG](#) [AP7315-33W5-7](#) [LD56100DPU28R](#) [NCP154MX180300TAG](#)
[AP2210K-3.0TRE1](#) [AP2113AMTR-G1](#) [NJW4104U2-33A-TE1](#) [MP2013AGG-5-P](#) [NCV8775CDT50RKG](#) [NJM2878F3-45-TE1](#) [S-](#)
[19214B00A-V5T2U7](#) [S-19214B50A-V5T2U7](#) [S-19213B50A-V5T2U7](#) [S-19214BC0A-E8T1U7*1](#)