

GENERAL DESCRIPTION

The LW54XX Series is an ultra-low noise, high PSRR LDO with enable function that operates from 1.9V to 5.5V. It provides up to 500mA output current.

The features of low noise and high PSRR make LW54XX ideal for noise-sensitive and analog applications.

The LW54XX Series integrate current limit, short circuit, thermal shut down, that protecting IC from being damaged.

Output voltage is selectable from 1.2V to 5.0V which fixed by laser trimming technologies, Step=50mV.

The LW54XX Series is available in SOT23-5L, DFN1x1-4L and DFN2x2-6L packages.

TYPICAL APPLICATION CIRCUIT

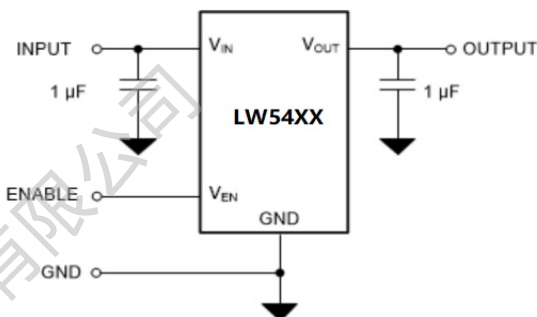

FEATURES

- Ultra-Low Noise: $5.29 \mu V_{RMS}$
- Output Accuracy: $\pm 1\%$
- Low Quiescent Current: 10uA
- Low Dropout Voltage: 33mV@100mA/3.3V
- High PSRR: 90dB@1KHz,10mA
- Output Current: 500mA
- Excellent Line and Load Regulation
- Operating Voltage Range: from 1.9V to 5.5V
- Output Voltage Range: from 1.2V to 5.0V
- Soft-Start Function
- Inrush Current Limit: 250mA
- Over-Temperature Protection
- Current Limiting and Short-Circuit Protection
- Available in SOT23-5L, DFN1x1-4L and DFN2x2-6L Packages

APPLICATIONS

- Mobile Phones, Tablets, Digital Cameras
- Audio Devices
- RF Modules
- Clock Generator: VCO, PLL, etc.
- Noise-Sensitive Devices: ADC, DAC

TYPICAL PERFORMANCE CHARACTERISTICS

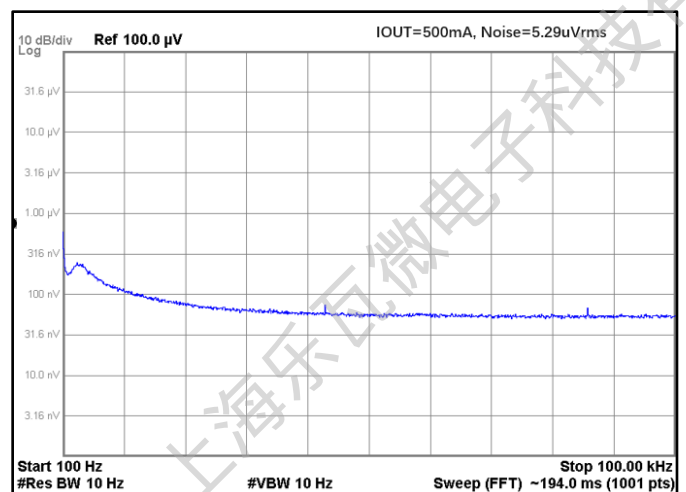

PIN DESCRIPTION:

PIN No			SYMBOL	DESCRIPTION
SOT23-5L	DFN1x1-4L	DFN2x2-6L		
1	4	6	VIN	Power Supply Input
2	2, E-PAD	3, E-PAD	GND	Ground
3	3	4	EN	Chip Enable
4	--	2,5	NC	Not Connected
5	1	1	VOUT	Output

PIN ASSIGNMENT

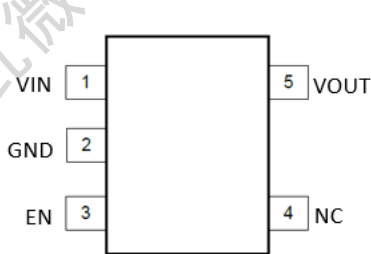

SOT23-5L

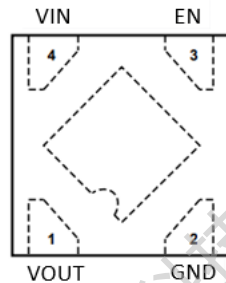

DFN1x1-4L

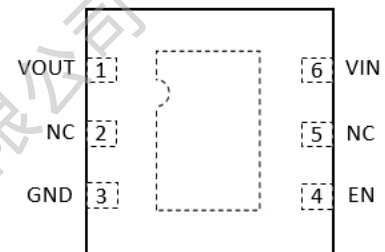

DFN2x2-6L

MARK INFORMATION:

SOT23-5L

XX: VOLTAGE

YY: DATE CODE

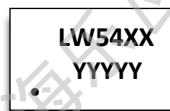

DFN2x2-6L

XX: VOLTAGE

YY: DATE CODE

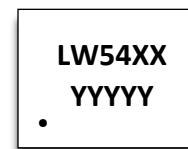

DFN1X1-4L

X: VOLTAGE



1.2V	1.5V	1.8V	2.5V	2.8V	3.0V	3.3V	3.6V	4.2V	5.0V
C	D	G	H	J	L	M	P	S	T

ABSOLUTE MAXIMUM RATINGS ⁽¹⁾:

(T_A =25°C, unless otherwise specified.)

SYMBOL	ITEM	RATING	UNIT
V _{IN}	Supply Voltage	-0.3~6.5	V
V _{EN}	EN Pin Voltage	-0.3~6.5	V
V _{OUT}	VOUT pin Voltage	-0.3~6.0	V
V _(ESD)	ESD Susceptibility, HBM ⁽²⁾	±4000	V
PD	Maximum Power Dissipation	SOT23-5L	450
		DFN1x1-4L	415
		DFN2x2-6L	1600
PTR	Package Thermal Resistance Θ_{JA}	SOT23-5L	278
		DFN1x1-4L	300
		DFN2x2-6L	80
T _J	Junction Temperature Range	-40~150	°C
T _{STG}	Storage Temperature Range	-40~150	°C
T _{SOLDER}	Lead Temperature (Soldering)	260°C, 10s	

Note:

1. Stresses beyond those listed under Absolute Maximum Ratings may cause permanent damage to the device. These are stress ratings only, and functional operation of the device at these or any other conditions beyond those indicated under Recommended Operating Conditions is not implied. Exposure to absolute-maximum-rated conditions for extended periods may affect device reliability

2. per ANSI/ESDA/JEDEC JS-001

RECOMMENDED OPERATING RANGE:

SYMBOL	ITEM	VALUE	UNIT
V _{IN}	VIN Supply Voltage	1.9~5.5	V
V _{EN}	EN Pin Voltage	0~5.5	V
V _{OUT}	VOUT Pin Voltage	1.2~5.0	V
I _{OUT}	Output Current	0~500	mA
T _J	Junction Temperature Range	-40~125	°C

ELECTRICAL CHARACTERISTICS:

($V_{IN}=V_{OUT}+1V$, $V_{OUT}=1.8V$, $C_{IN}=C_{OUT}=1\mu F$, $T_A=25^\circ C$, unless otherwise specified.)

Symbol	Parameter	Test Conditions	MIN	TYP	MAX	Units	
V_{IN}	Input Voltage		1.9		5.5	V	
V_{OUT}	Output Accuracy	$I_{OUT}=1mA$	-1.0		+1.0	%	
I_{LIM}	Current Limit ⁽¹⁾	$V_{IN}=2.8V$, $V_{OUT}=1.8V$	550	700		mA	
		$V_{IN}=4.3V$, $V_{OUT}=3.3V$	550	700			
I_Q	Quiescent Current	$V_{IN}=V_{EN}=V_{OUT}+1V$, No Load		10	15	μA	
I_{SHD}	Shutdown Current	$V_{IN}=5.5V$, $V_{EN}=0V$			0.1	μA	
V_{DROP}	Dropout Voltage ⁽²⁾	$I_{OUT}=100mA$, $V_{OUT}=1.8V$		60		mV	
		$I_{OUT}=500mA$, $V_{OUT}=1.8V$		300			
		$I_{OUT}=100mA$, $V_{OUT}=3.3V$		33			
		$I_{OUT}=500mA$, $V_{OUT}=3.3V$		170			
S_{LINE}	Line Regulation	$V_{IN}=V_{OUT}+1V$ to 5.5V, $I_{OUT}=1mA$		0.05	0.25	%/V	
S_{LOAD}	Load Regulation	$1mA \leq I_{OUT} \leq 500mA$		0.001	0.005	%/mA	
I_{SHORT}	Short Current	$V_{OUT}=0V$		50		mA	
I_{EN}	EN Pull-Down Current	$V_{IN}=V_{EN}=5.5V$		0.15		μA	
V_{ENH}	EN High Voltage	$V_{IN}=1.9V$ to 5.5V, $I_{OUT}=1mA$	1.5			V	
V_{ENL}	EN Low Voltage				0.4	V	
PSRR	Power Supply Rejection Ratio	$C_{IN}=None$, $V_{OUT}=3.3V$, $I_{OUT}=10mA$	$f=217Hz$		90		dB
			$f=1KHz$		90		
			$f=10KHz$		88		
			$f=100KHz$		60		
e_N	Output Noise Voltage	$V_{OUT}=3.3V$, BW=10Hz to 100kHz	$I_{OUT}=1mA$		5.93		μV_{RMS}
			$I_{OUT}=500mA$		5.29		
T_{SD}	Overheat Protection	Temperature rising		160		$^\circ C$	
ΔT_{SD}	TSD Hysteresis	Temperature falling		20		$^\circ C$	
R_{DSCHG}	R_{ON} of V_{OUT} Discharge MOSFET	$V_{IN}=5.5V$, $V_{EN}=0V$		60		Ω	

NOTES:

1. Guaranteed by design
2. The dropout voltage is defined as $V_{IN} - V_{OUT}$, when $V_{OUT}=95\%*V_{OUT(NOM)}$

SIMPLIFIED BLOCK DIAGRAM:

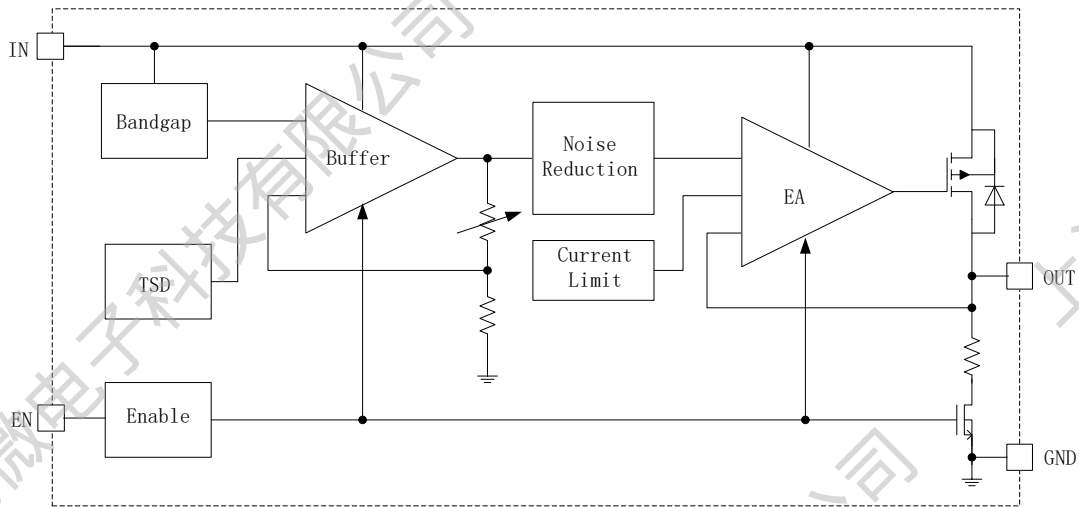

DETAIL OPERATION DESCRIPTION:

The LW54XX is a low noise, high PSRR, low quiescent current, low drop-out voltage regulator. The input voltage range is from 1.9V to 5.5V, and the output current is up to 500mA.

Error Amplifier

The Error Amplifier (EA) compares the internal reference voltage VREF with the output feedback voltage. Output of the error amplifier (EA) is used to control the gate voltage of P-MOSFET and ensures that the device provides good line and load regulation.

Current Limit and Short Circuit Protection

LW54XX provides current limit function to prevent the device from damaging during overload or shorted-circuit condition. The output current is limited to 700mA (typ.), and the output short circuit current is limited to 50mA(typ.)

Thermal Shutdown Protection

When the junction temperature exceeds 160°C(typ.), thermal shutdown is triggered and the device turns off. When the junction temperature falls below 140°C (typ.), the device turns on again.

Soft-Start and Inrush Current Limit

The inrush current protection circuit is built in the LW54XX. During appr.650μs(typ.) after the EN pin becomes "H", the inrush current is limited at appr.250 mA.

TYPICAL OPERATING CHARACTERISTICS:

(Tested under $T_J = 25^\circ\text{C}$, unless otherwise specified)

1. V_{OUT} vs Temperature

LW5433 ($V_{IN}=4.3\text{V}$, $I_{OUT}=10\text{mA}$)

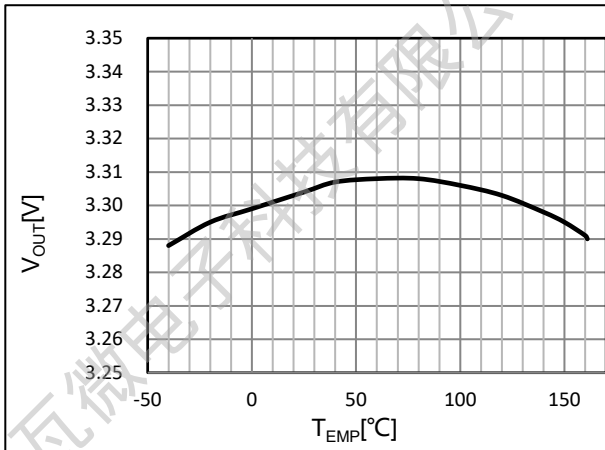

2. I_Q vs V_{IN}

LW5418 ($V_{IN}=2.8\text{V}$, $I_{OUT}=0\text{mA}$)

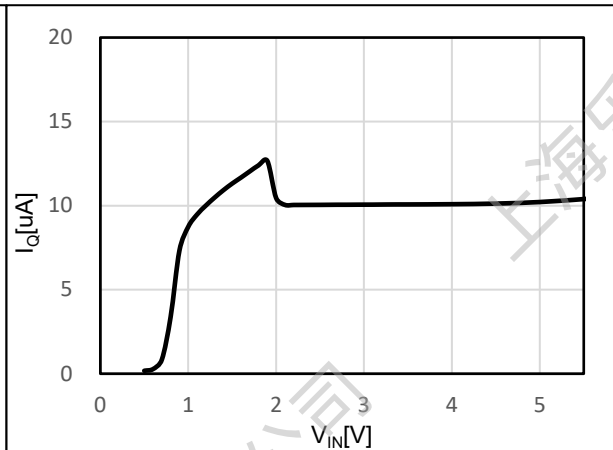

3. Dropout Voltage vs I_{OUT}

LW5418 ($V_{OUT}=95\% \cdot 1.8\text{V}$, $I_{OUT}=0 \rightarrow 500\text{mA}$)

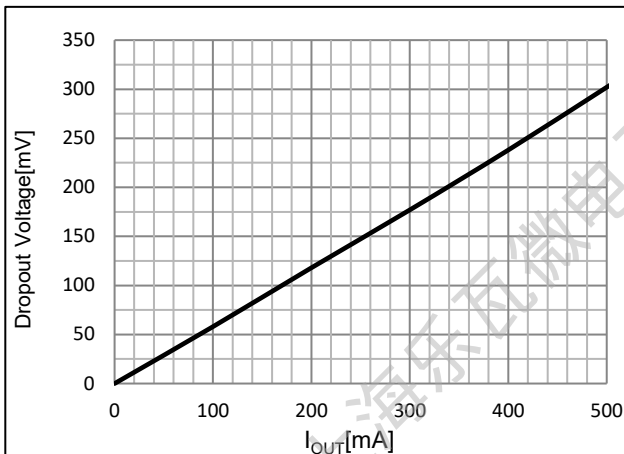

LW5430 ($V_{OUT}=95\% \cdot 3.0\text{V}$, $I_{OUT}=0 \rightarrow 500\text{mA}$)

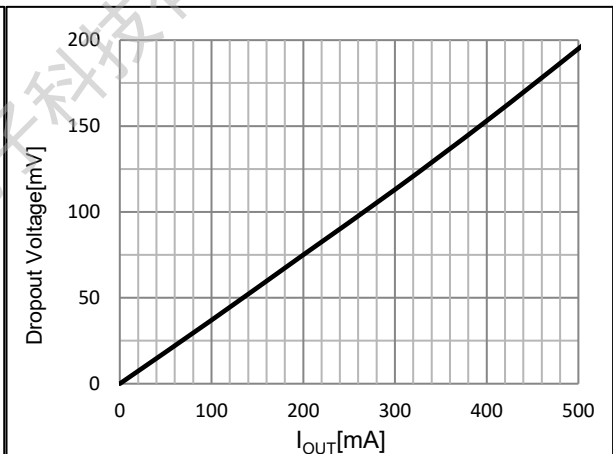

4. V_{OUT} vs I_{OUT}

LW5418 ($V_{IN}=2.8\text{V}$, $I_{OUT}=1 \rightarrow 500\text{mA}$)

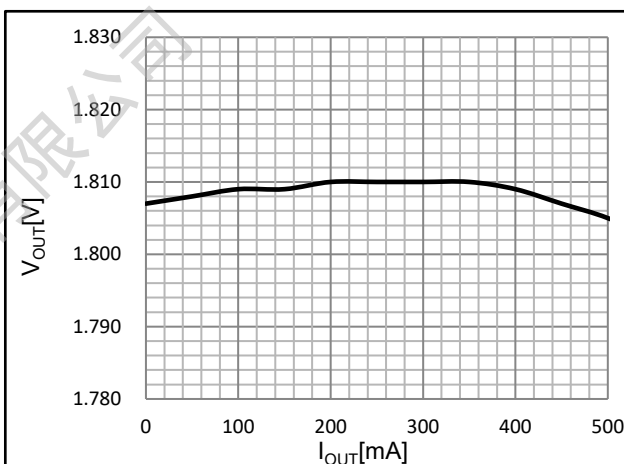

5. V_{OUT} vs V_{IN}

LW5418 ($V_{IN}=2.0\text{V} \rightarrow 5.5\text{V}$, $V_{OUT}=1.8\text{V}$, $I_{OUT}=1\text{mA}$)

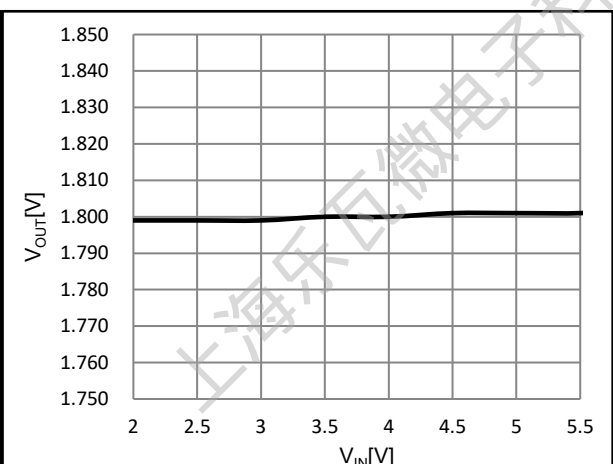

6. VEN Thresholds vs VIN

LW5418 ($V_{IN}=2.8V, I_{OUT}=0mA$)

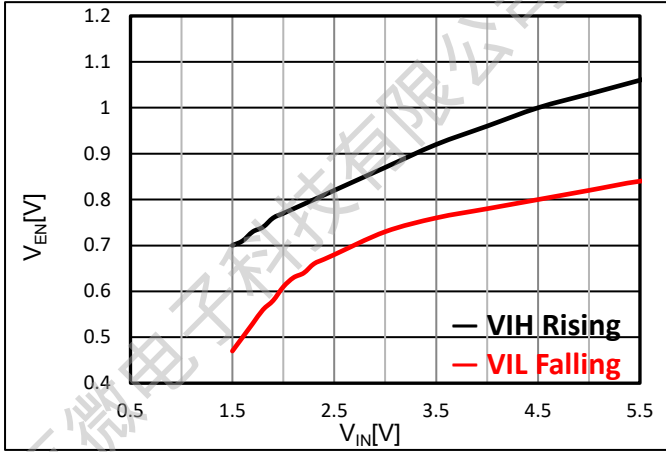

7. Line Transient

LW5430 ($V_{IN}=4.0V \rightarrow 5.0V, I_{OUT}=1mA$)

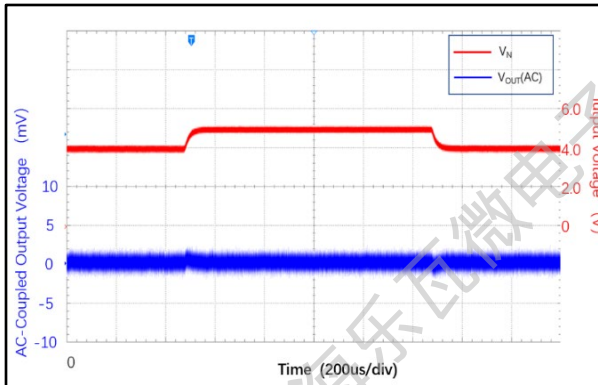

8. Load Transient

LW5412 ($V_{IN}=2.2V, I_{OUT}=1 \rightarrow 500mA$)

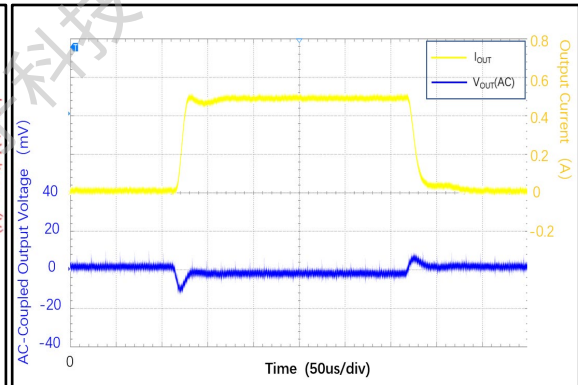

LW5418 ($V_{IN}=2.8V, I_{OUT}=1 \rightarrow 500mA$)

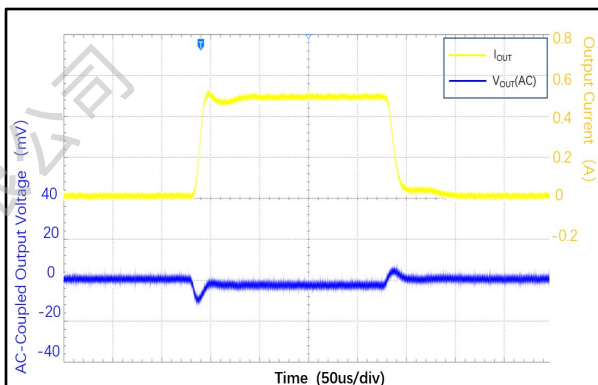

LW5430 ($V_{IN}=4.0V, I_{OUT}=1 \rightarrow 500mA$)

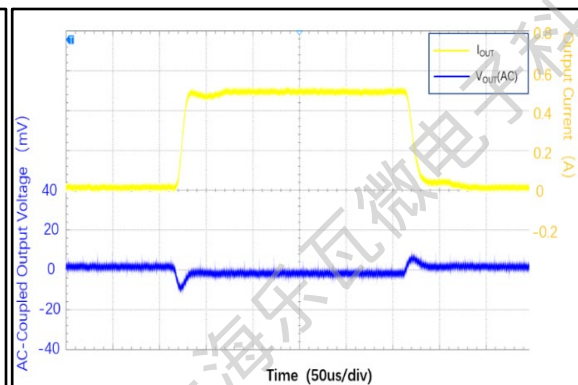

9.Start-Up through EN

LW5412 ($V_{EN}=0V \rightarrow 2.2V$, No load)



LW5412 ($V_{EN}=0V \rightarrow 2.2V$, $R_{OUT}=12\Omega$)

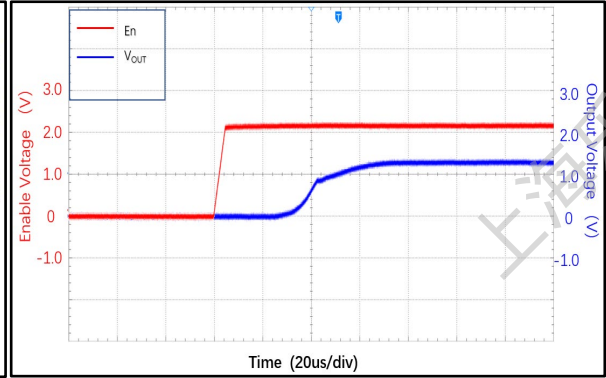

LW5418 ($V_{EN}=0V \rightarrow 2.8V$, No load)

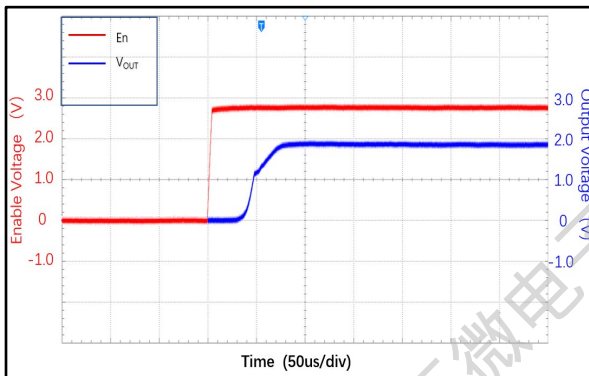

LW5418 ($V_{EN}=0V \rightarrow 2.8V$, $R_{OUT}=18\Omega$)

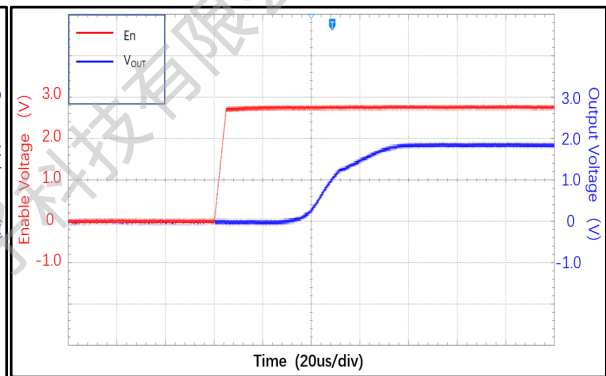

LW5430 ($V_{EN}=0V \rightarrow 4.0V$, No load)

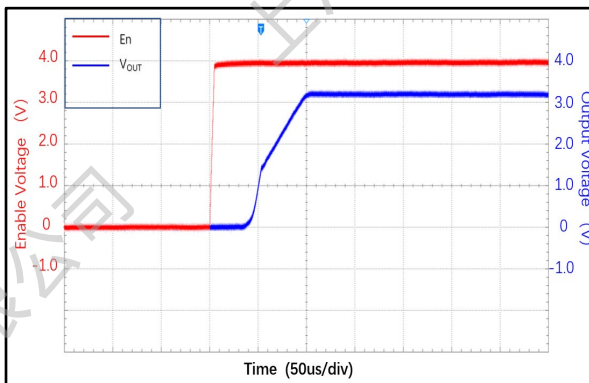

LW5430 ($V_{EN}=0V \rightarrow 4.0V$, $R_{OUT}=30\Omega$)

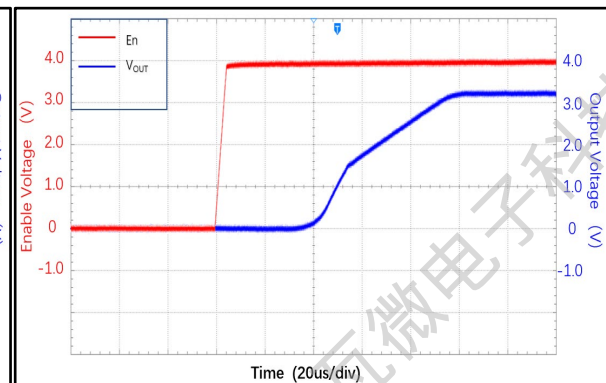

10. Shut-Down through EN

LW5412 ($V_{EN}=2.2V \rightarrow 0V$, No load)

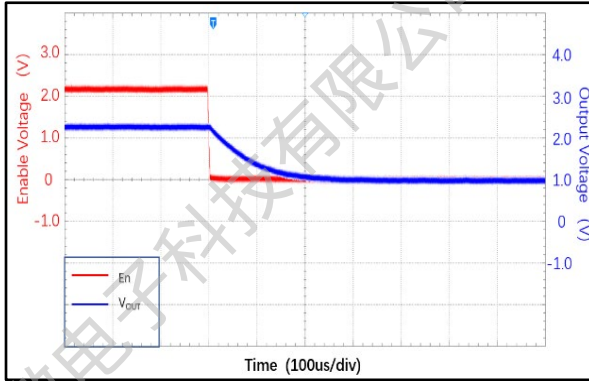

LW5412 ($V_{EN}=2.2V \rightarrow 0V$, $R_{OUT}=12\Omega$)

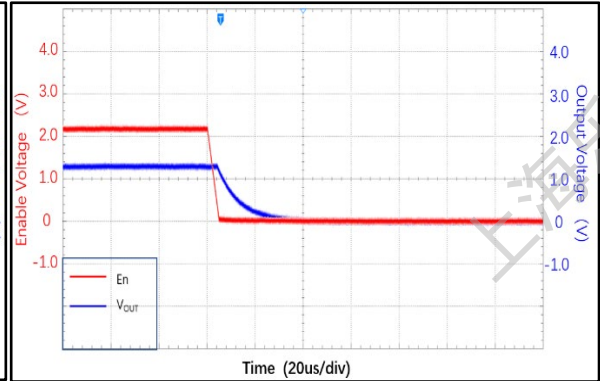

LW5418 ($V_{EN}=2.8V \rightarrow 0V$, No load)

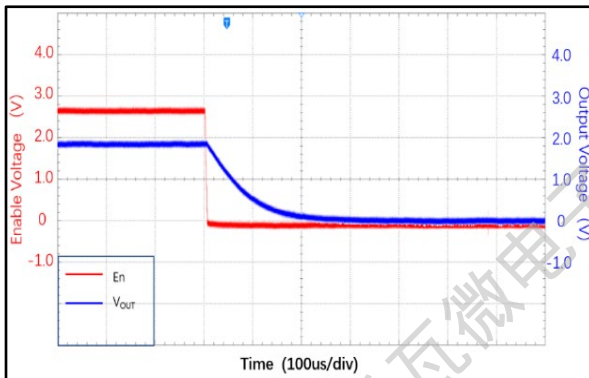

LW5418 ($V_{EN}=2.8V \rightarrow 0V$, $R_{OUT}=18\Omega$)

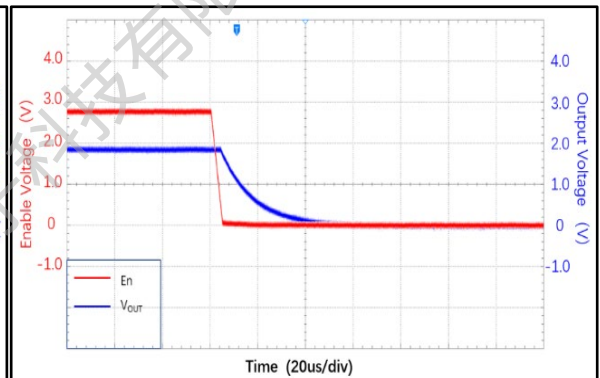

LW5430 ($V_{EN}=4.0V \rightarrow 0V$, No load)

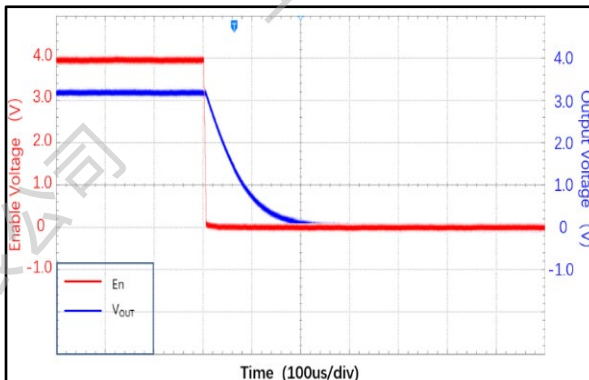

LW5430 ($V_{EN}=4.0V \rightarrow 0V$, $R_{OUT}=30\Omega$)

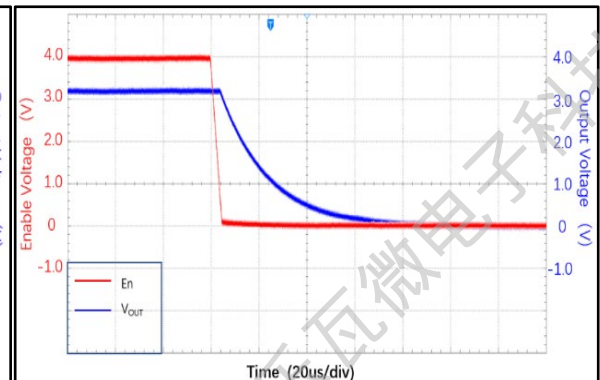

11. PSRR vs Frequency

LW5433 ($V_{IN}=4.3V$, $V_{PP}=0.5V$, C_{IN} =none, C_{OUT} =1 μF)

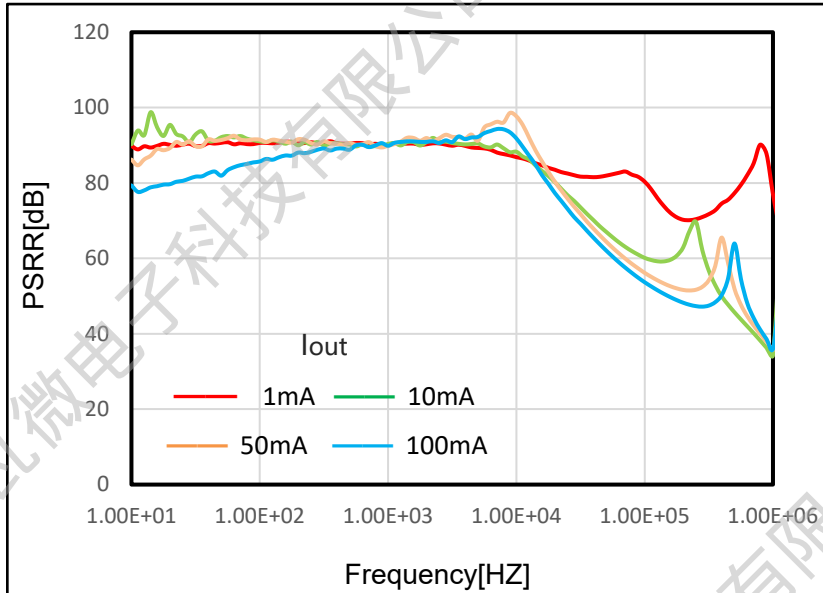

12. Inrush Current

LW5412 ($V_{IN}=2.2V$, C_{OUT} =1 μF , No load)

LW5412 ($V_{IN}=2.2V$, C_{OUT} =2.2 μF , No load)

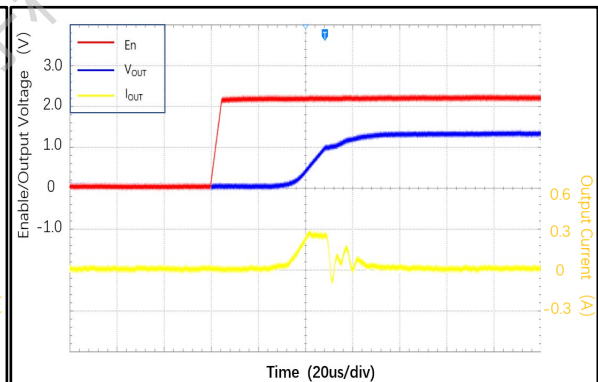
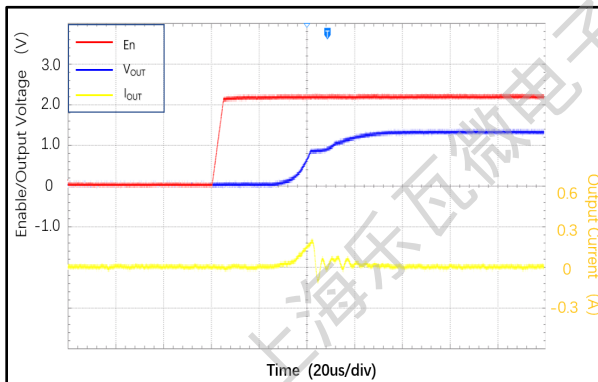

LW5412 ($V_{IN}=2.2V$, C_{OUT} =10 μF , No load)

LW5418 ($V_{IN}=2.8V$, C_{OUT} =1 μF , No load)

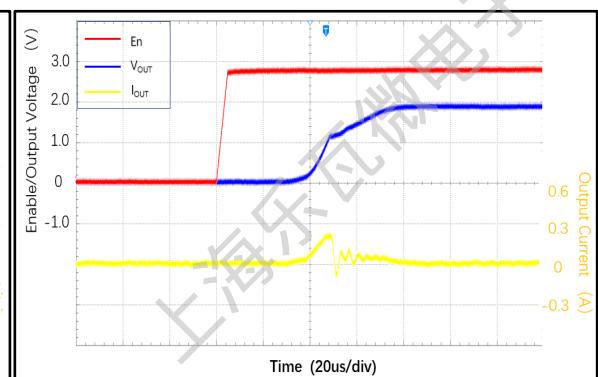
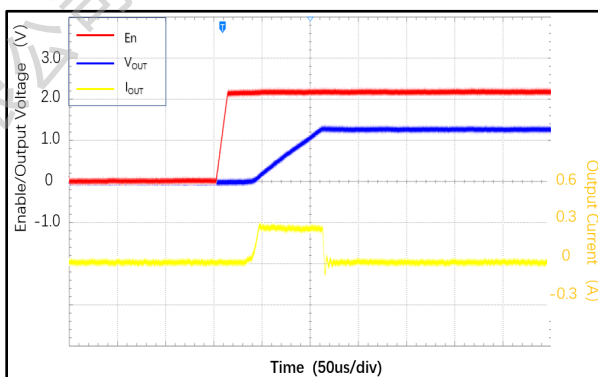

LW5418 ($V_{IN}=2.8V$, $C_{OUT}=2.2\mu F$, No load)

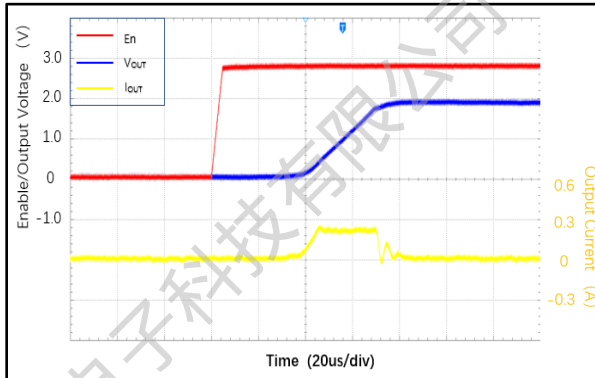

LW5418 ($V_{IN}=2.8V$, $C_{OUT}=10\mu F$, No load)

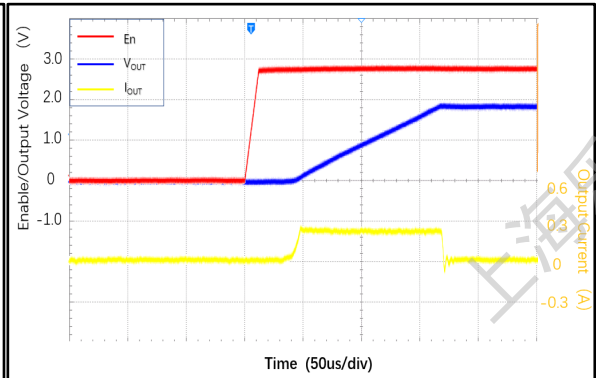

LW5430 ($V_{IN}=4.0V$, $C_{OUT}=1\mu F$, No load)

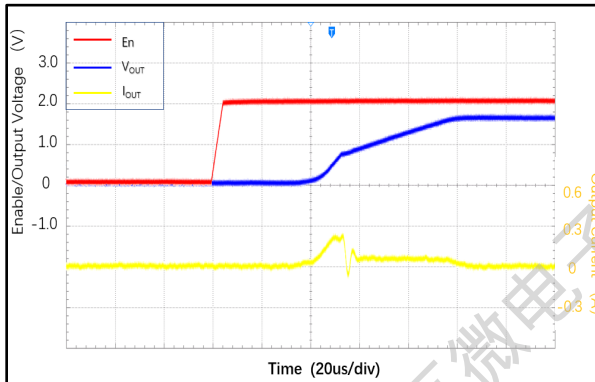

LW5430 ($V_{IN}=4.0V$, $C_{OUT}=2.2\mu F$, No load)

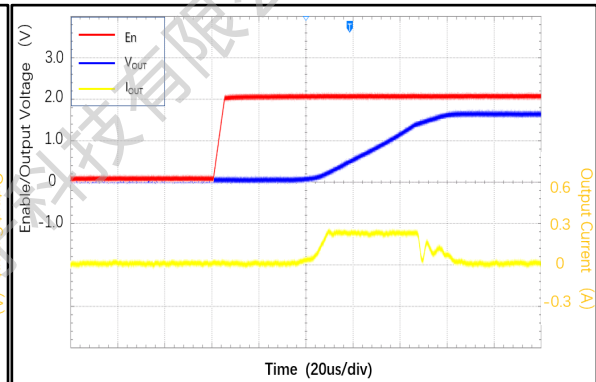

LW5430 ($V_{IN}=4.0V$, $C_{OUT}=10\mu F$, No load)

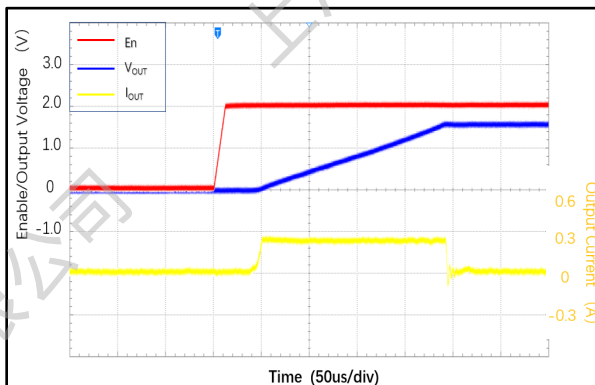

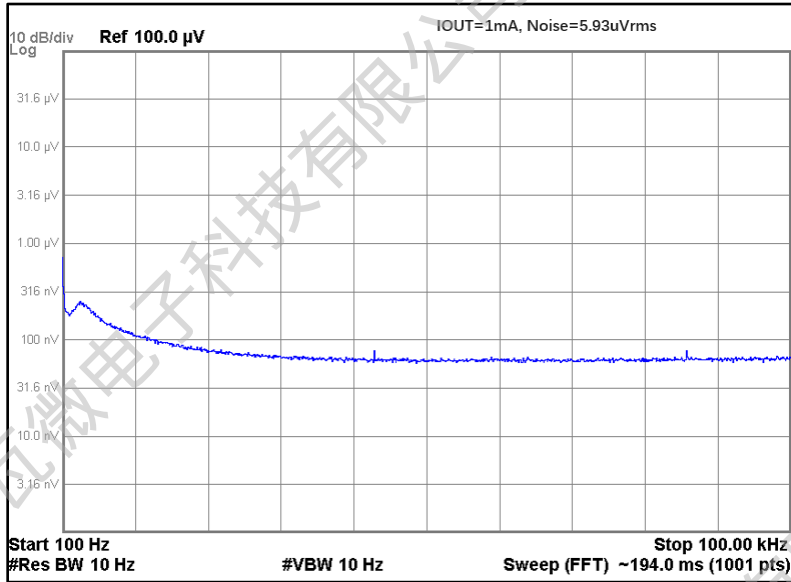
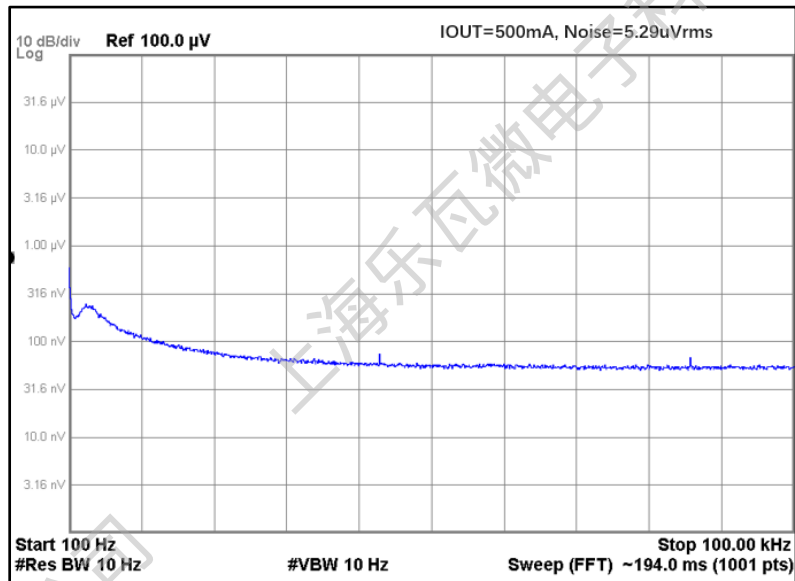
13. Output Noise Spectral Density vs FrequencyLW5433 ($V_{IN}=4.3V$, $C_{IN}=C_{OUT}=1\mu F$, $I_{LOAD}=1mA$)LW5433 ($V_{IN}=4.3V$, $C_{IN}=C_{OUT}=1\mu F$, $I_{LOAD}=500mA$)

APPLICATION INFORMATION:

- **Input Capacitor Selection**

Like any low-dropout regulator, the external capacitors used with the LW54XX Series must be carefully selected for regulator stability and performance. Using a capacitor whose value is $\geq 1\mu\text{F}$ on the LW54XX Series input and the amount of capacitance can be increased without limit. An at least $10\mu\text{F}$ input capacitor is needed if input ripple voltage $V_{pp} > 1\text{V}$. The input capacitor must be located a distance less than 0.5 inch from the input pin of the IC and returned to a clean analog ground. Any good quality ceramic or tantalum can be used for this capacitor. The capacitor with larger value and lower ESR (equivalent series resistance) provides better PSRR and line-transient response.

- **Layout considerations**

To improve ac performance such as PSRR, output noise, and transient response, it is recommended that the PCB be designed with separate ground planes for VIN and VOUT, with each ground plane connected only at the GND pin of the device.

- **Output Capacitor Selection**

The output capacitor must meet both requirements for minimum amount of capacitance and ESR in all LDOs application. The LW54XX Series is designed specifically to work with low ESR ceramic output capacitor in space-saving and performance consideration. Using a ceramic capacitor whose value is at least $1\mu\text{F}$ on the LW54XX Series output ensures stability. An appropriate output capacitor can reduce noise and improve load transient response and PSRR. The output capacitor should be located not more than 0.5 inch from the VOUT pin of the LW54XX Series and returned to a clean analog ground.

ORDER INFORMATION:

LW54①②③④⑤⑥

Designator	Item	Symbol	Description
①②	Output Voltage	12~50	e.g. 1.2V → ①=1, ②=2
③④⑤⑥	Packages	A23E	SOT23-5L
		N11E	DFN1x1-4L
		N22G	DFN2x2-6L

Part #	Output Voltage	Package	Shipping
LW5412A23E	1.2V	SOT23-5L	3000 Pcs/ Tape & Reel
LW5415A23E	1.5V		
LW5418A23E	1.8V		
LW5425A23E	2.5V		
LW5428A23E	2.8V		
LW5430A23E	3.0V		
LW5433A23E	3.3V		
LW5436A23E	3.6V		
LW5442A23E	4.2V		
LW5450A23E	5.0V		
LW5412N11E	1.2V		
LW5415N11E	1.5V		
LW5418N11E	1.8V		
LW5425N11E	2.5V		
LW5428N11E	2.8V		
LW5430N11E	3.0V		
LW5433N11E	3.3V		
LW5436N11E	3.6V		
LW5442N11E	4.2V		
LW5450N11E	5.0V		

Part #	Output Voltage	Package	Shipping
LW5412N22G	1.2V	DFN2x2-6L	3000 Pcs/ Tape & Reel
LW5415N22G	1.5V		
LW5418N22G	1.8V		
LW5425N22G	2.5V		
LW5428N22G	2.8V		
LW5430N22G	3.0V		
LW5433N22G	3.3V		
LW5436N22G	3.6V		
LW5442N22G	4.2V		
LW5450N22G	5.0V		

If customers have special output voltage requirements, please contact us.

PACKAGE OUTLINE:

SOT23-5L Package

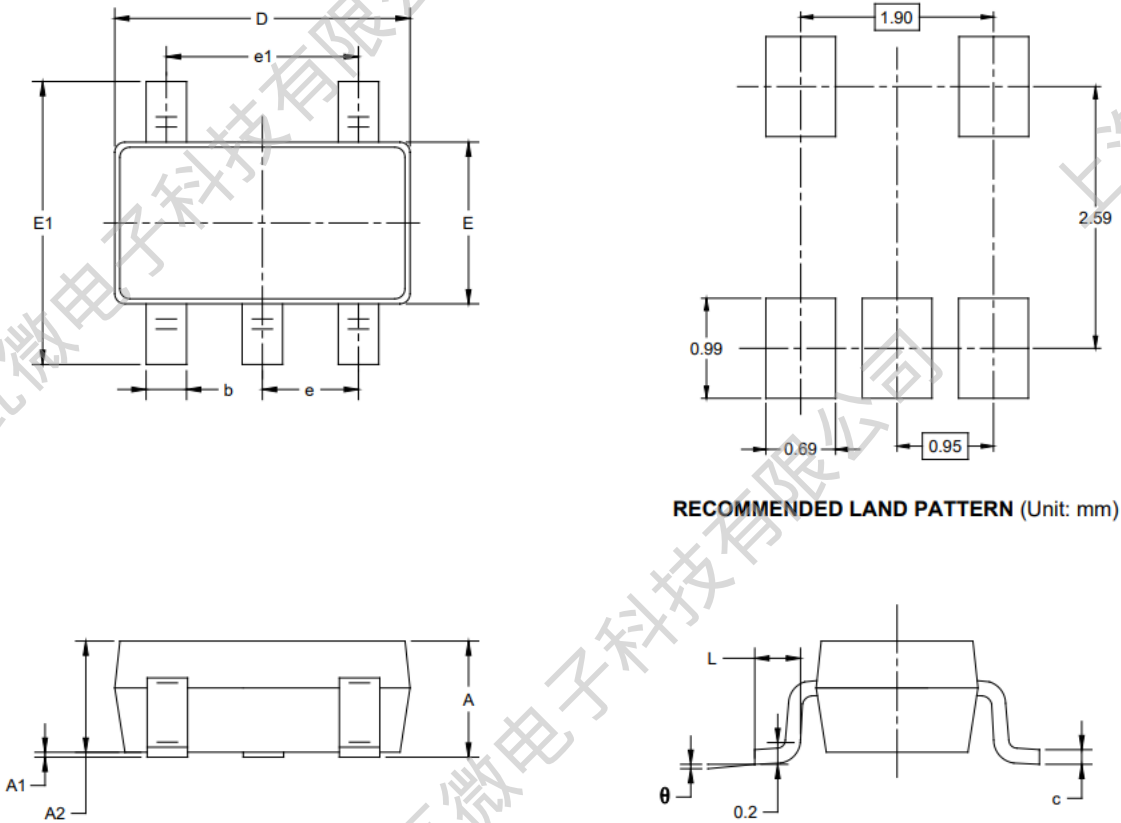

Symbol	Dimensions In Millimeters		Dimensions In Inches	
	MIN	MAX	MIN	MAX
A	1.050	1.250	0.041	0.049
A1	0.000	0.100	0.000	0.004
A2	1.050	1.150	0.041	0.045
b	0.300	0.500	0.012	0.020
c	0.100	0.200	0.004	0.008
D	2.820	3.020	0.111	0.119
E	1.500	1.700	0.059	0.067
E1	2.650	2.950	0.104	0.116
e	0.950 BSC		0.037 BSC	
e1	1.900 BSC		0.075 BSC	
L	0.300	0.600	0.012	0.024
θ	0°	8°	0°	8°

DFN1x1-4L Package

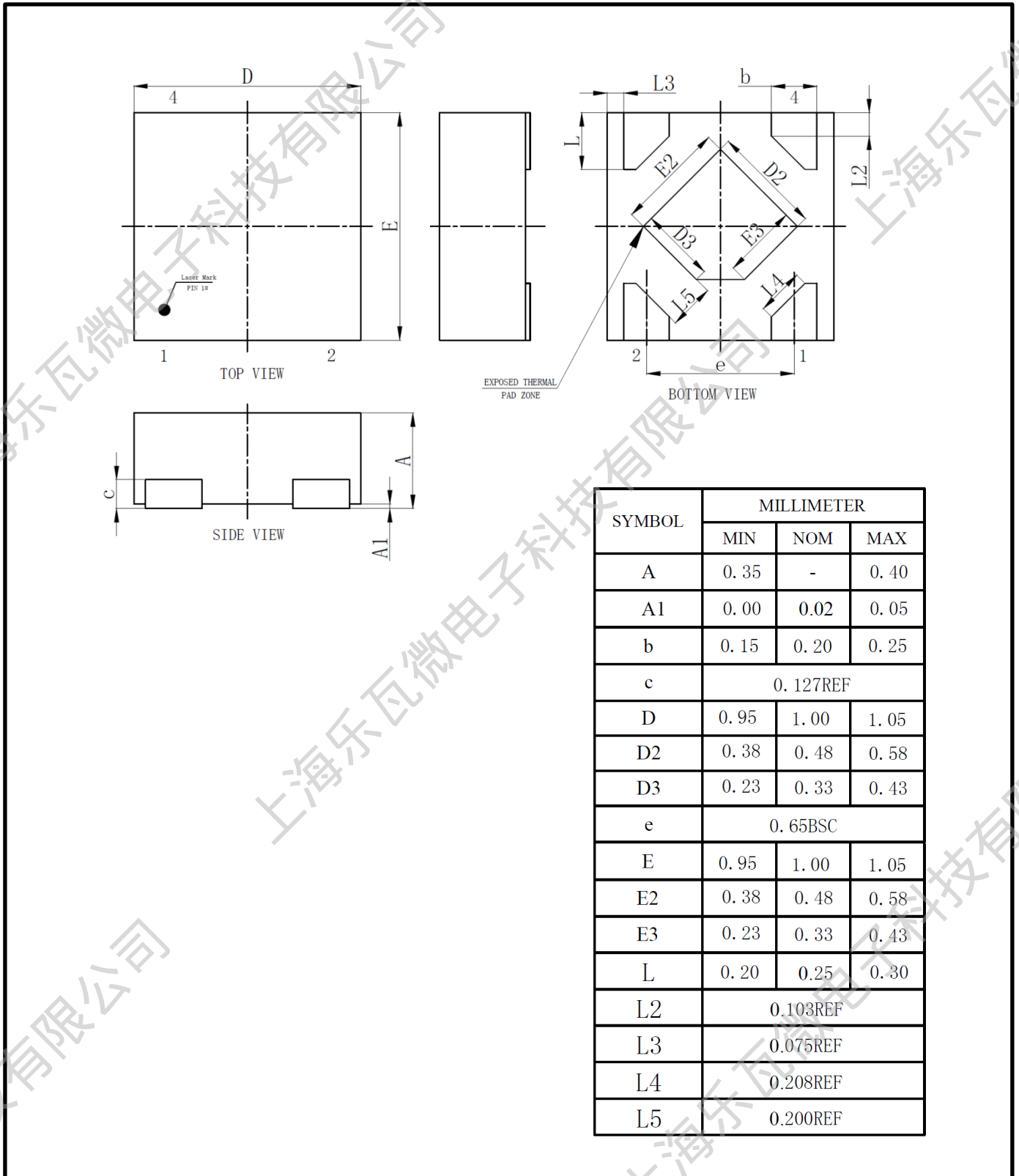

DFN2x2-6L Package

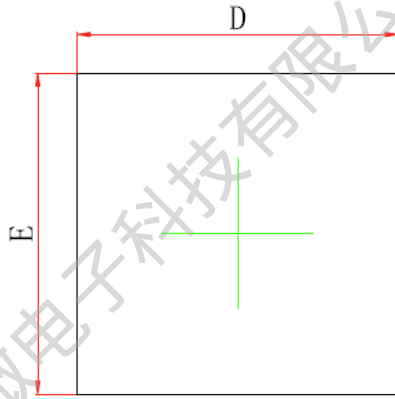

TOP VIEW
[顶视图]

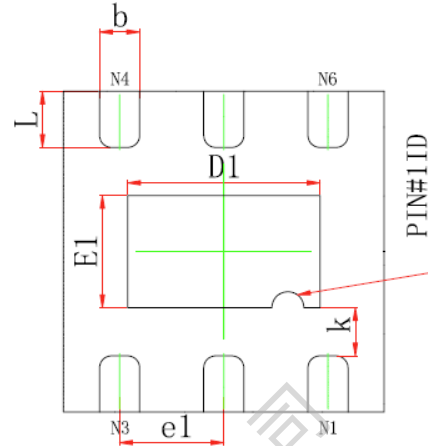

BOTTOM VIEW
[背视图]

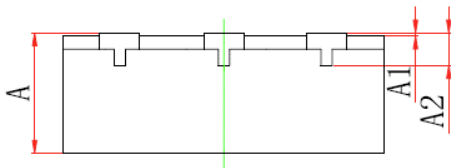

SIDE VIEW
[侧视图]

Symbol	Dimensions In Millimeters		Dimensions In Inches	
	Min.	Max.	Min.	Max.
A	0.700	0.800	0.028	0.031
A1	0.000	0.050	0.000	0.002
A2	0.203REF.		0.008REF.	
D	1.924	2.076	0.076	0.082
E	1.924	2.076	0.076	0.082
D1	1.150	1.250	0.045	0.049
E1	0.650	0.750	0.026	0.030
b	0.200	0.300	0.008	0.012
e1	0.650TYP.		0.026TYP.	
k	0.200MIN.		0.008MIN.	
L	0.300	0.400	0.012	0.016

Revision History:

Revision	Date	Descriptions
Rev 1.0	Aug.2023	Released Version
Rev 1.1	Nov.2023	Update new Package (DFN2x2-6L)

DISCLAIMER:

The information in this document is believed to be accurate and reliable. However, no responsibility is assumed by LW-Micro for its use. All operating parameters must be designed, validated and tested to ensure they meet the requirements of your application. LW-Micro reserves the right to make any specification and/or circuitry changes without prior notification. Before starting a brand-new project, please contact LW-Micro Sales to get the most recent relevant information.

Mailing Address: Room 301, Building 2, No.1690 CaiLun Road, China (Shanghai) Pilot Free Trade Zone
Shanghai Lewa Micro-electronics Technology Co., Ltd

X-ON Electronics

Largest Supplier of Electrical and Electronic Components

Click to view similar products for [LDO Voltage Regulators](#) category:

Click to view products by [Lewa Micro](#) manufacturer:

Other Similar products are found below :

[AP7363-SP-13](#) [NCV8664CST33T3G](#) [L79M05TL-E](#) [AP7362-HA-7](#) [PT7M8202B12TA5EX](#) [TCR3DF185,LM\(CT](#) [TLF4949EJ](#)
[NCP4687DH15T1G](#) [NCV8703MX30TCG](#) [LP2951CN](#) [NCV4269CPD50R2G](#) [AP7315-25W5-7](#) [NCV47411PAAJR2G](#) [AP2111H-1.2TRG1](#)
[ZLDO1117QK50TC](#) [AZ1117ID-ADJTRG1](#) [NCV4263-2CPD50R2G](#) [NCP114BMX075TCG](#) [MC33269T-3.5G](#) [TLE4471GXT](#) [AP7315-33SA-](#)
[7](#) [NCV4266-2CST33T3G](#) [NCP715SQ15T2G](#) [NCV8623MN-50R2G](#) [NCV563SQ18T1G](#) [NCV8664CDT33RKG](#) [NCV4299CD250R2G](#)
[NCP715MX30TBG](#) [NCV8702MX25TCG](#) [L974113TR](#) [TLE7270-2E](#) [NCV562SQ25T1G](#) [AP2213D-3.3TRG1](#) [AP2202K-2.6TRE1](#)
[NCV8170BMX300TCG](#) [NCV8152MX300180TCG](#) [NCP700CMT45TBG](#) [AP7315-33W5-7](#) [LD56100DPU28R](#) [NCP154MX180300TAG](#)
[AP2210K-3.0TRE1](#) [AP2113AMTR-G1](#) [NJW4104U2-33A-TE1](#) [MP2013AGG-5-P](#) [NCV8775CDT50RKG](#) [NJM2878F3-45-TE1](#) [S-](#)
[19214B00A-V5T2U7](#) [S-19214B50A-V5T2U7](#) [S-19213B50A-V5T2U7](#) [S-19214BC0A-E8T1U7*1](#)