

### ■ GENERATION DESCRIPTION

The LW55XX Series is a 40V  $\mu$ A-power high accuracy LDO regulator. The  $\mu$ A-power consumption makes it ideal for most HV power-saving systems. The maximum operating voltage can be as high as 40V. The output accuracy is as excellent as  $\pm 1.0\%$ .

The other features include low dropout voltage, current limiting protection and thermal shutdown protection.

The LW55XX Series is available in SOT23-3L, SOT23-5, SOT89-3 and TO-252 packages.

### ■ APPLICATIONS

- Battery Supplied Systems
- Telecom Systems
- Audio & Video Devices

### ■ TYPICAL APPLICATION CIRCUIT

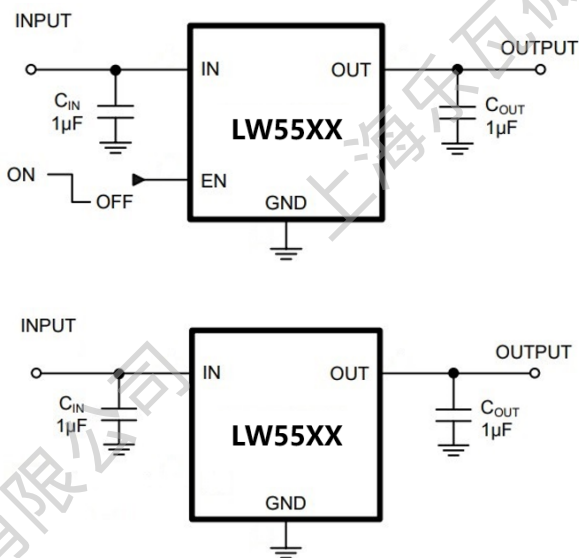

### ■ FEATURES

- Maximum Operating Voltage: 40V
- Output Voltage: 1.8V, 2.5V, 3.0V, 3.3V, 3.6V, 4.0V, 4.2V and 5.0V
- Output Accuracy:  $\pm 1.0\%$
- Low Power Consumption: 1.3 $\mu$ A
- Low Standby Current When Shutdown
- Low Temperature Coefficient
- Current Limiting, Thermal Shutdown
- Available in SOT23-3L, SOT23-5, SOT89-3 and TO-252 Packages

### ■ TYPICAL PERFORMANCE CHARACTERISTICS

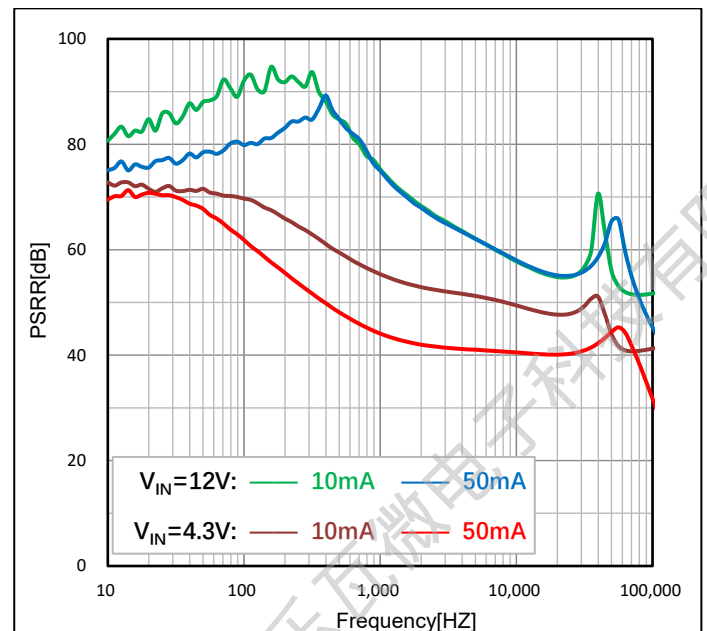

### ■ PIN DESCRIPTION

PIN No						SYMBOL	DESCRIPTION
SOT23-3L	SOT23-5A	SOT23-5B	SOT89-3A	SOT89-3B	TO-252		
1	2	1	1	2	2	GND	Ground
2	5	3	3	1	3	VOUT	Output
3	1	2	2	3	1	VIN	Power Supply Input
-	3	-	-	-	-	EN	Chip Enable
-	4	4,5	-	-	-	NC	Not Connected

### ■ PIN ASSIGNMENT

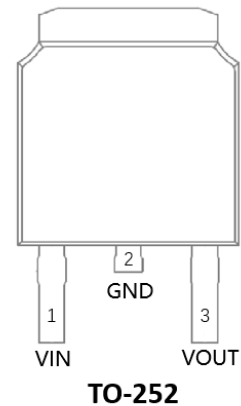
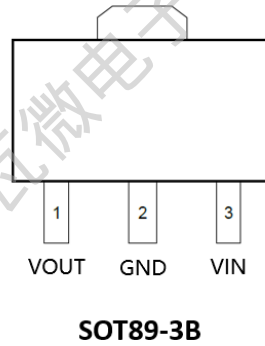
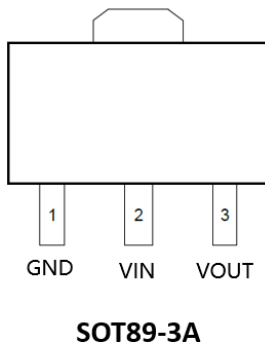
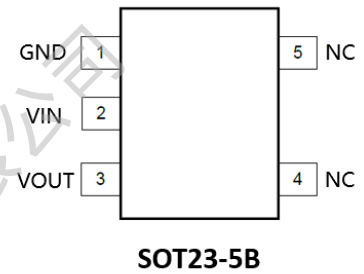
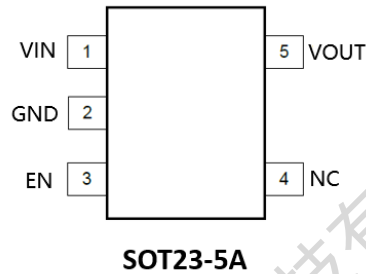
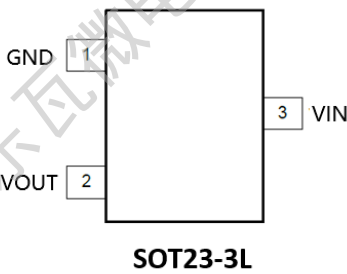

### ■ MARK INFORMATION:

**SOT23-3L, SOT23-5, SOT89-3, TO-252**

**XX: VOLTAGE**

**YY: DATE CODE**

LW55XX  
YYYYY

### ■ ABSOLUTE MAXIMUM RATINGS <sup>(1)</sup>

( $T_A = 25^\circ\text{C}$ , unless otherwise specified.)

Symbol	Item	Rating	Unit	
$V_{IN}$	Supply Voltage	-0.3~44	V	
$V_{EN}$	EN pin to GND Voltage	-0.3~44	V	
$V_{OUT}$	VOOUT pin Voltage	-0.3~6.0	V	
$V_{(ESD)}$	ESD Susceptibility, Human-body model <sup>(2)</sup>	+/-2000	V	
$P_D$	Maximum Power Dissipation	SOT23-3L	0.4	W
		SOT23-5	0.6	W
		SOT89-3	1.2	W
		TO-252	2.3	W
$R_{\theta JA}$	Junction-to-ambient Thermal Resistance	SOT23-3L	312	$^\circ\text{C}/\text{W}$
		SOT23-5	208	$^\circ\text{C}/\text{W}$
		SOT89-3	104	$^\circ\text{C}/\text{W}$
		TO-252	55	$^\circ\text{C}/\text{W}$
$T_J$	Junction Temperature Range	-40~150	$^\circ\text{C}$	
$T_{STG}$	Storage Temperature Range	-40~150	$^\circ\text{C}$	
$T_{SOLDER}$	Lead Temperature (Soldering)	260 $^\circ\text{C}$ , 10s		

#### Note:

1. Absolute Maximum Ratings are threshold limit values that must not be exceeded even for an instant under any condition. Moreover, such values for any two items must not be reached simultaneously. Operation above these absolute maximum ratings may cause degradation or permanent damage to the device. These are stress ratings only and do not necessarily imply functional operation below these limits.

2. per ANSI/ESDA/JEDEC JS-001

### ■ RECOMMENDED OPERATING RANGE:

Symbol	Item	Rating	Unit
$V_{IN}$	VIN Supply Voltage	2.5~40	V
$V_{EN}$	EN Pin Voltage	0~40	V
$V_{OUT}$	VOOUT pin Voltage	1.8~5.0	V
$I_{OUT}$	Output Current	0~150	mA
$T_J$	Junction Temperature Range	-40~125	$^\circ\text{C}$

### ELECTRICAL CHARACTERISTICS

( $V_{IN}=V_{OUT}+1V$ ,  $V_{OUT}=3.3V$ ,  $C_{IN}=C_{OUT}=1\mu F$ ,  $T_A=25^\circ C$ , unless otherwise specified.)

Symbol	Parameter	Conditions	MIN	TYP	MAX	Unit	
$V_{IN}$	Input Voltage		2.5		40	V	
$V_{OUT}$	Output Voltage	$I_{OUT}=1mA$	-1.0		+1.0	%	
$I_{LIM}$	Current Limit <sup>(1)</sup>	$V_{IN}=5.0V$ , $V_{OUT}=3.3V$	150	250		mA	
$I_Q$	Quiescent Current	$V_{IN}=V_{OUT}+1V$ , No Load		1.3	2.0	$\mu A$	
$I_{SHD}$	Shutdown Current	$V_{IN}=12V$ , $V_{EN}=0V$		0.1	1.0	$\mu A$	
$V_{DROP}$	Dropout Voltage <sup>(2)</sup>	$I_{OUT}=10mA$ , $V_{OUT}=3.3V$		70		mV	
		$I_{OUT}=50mA$ , $V_{OUT}=3.3V$		350		mV	
		$I_{OUT}=100mA$ , $V_{OUT}=3.3V$		700		mV	
		$I_{OUT}=150mA$ , $V_{OUT}=3.3V$		1000		mV	
$S_{LINE}$	Line Regulation	$V_{IN}=V_{OUT}+1V$ to 40V, $I_{OUT}=1mA$		0.02	0.03	%/V	
$S_{LOAD}$	Load Regulation	$1mA \leq I_{OUT} \leq 100mA$		25	50	mV	
$I_{SHORT}$	Short Current	$V_{OUT}=0V$		90		mA	
$V_{ENH}$	EN High Voltage	$V_{IN}=12V$ , $I_{OUT}=1mA$	1.5			V	
$V_{ENL}$	EN Low Voltage				0.4	V	
$I_{ENH}$	EN High Current	$V_{IN}=12V$		0	0.1	$\mu A$	
$I_{ENL}$	EN Low Current	$V_{IN}=12V$ , $V_{EN}=0V$		0	0.1	$\mu A$	
PSRR	Power Supply Rejection Ratio	$C_{IN} = \text{None}$ , $f=1KHz$ , $I_{OUT}=10mA$	$V_{IN}=4.3V$		55		dB
			$V_{IN}=12V$		75		
$T_{SD}$	Thermal Shut Down	Temperature rising		165		$^\circ C$	
$\Delta T_{SD}$	TSD Hysteresis	Temperature falling		20		$^\circ C$	

#### Note:

1. Guaranteed by design
2. The dropout voltage is defined as  $V_{IN} - V_{OUT}$ , when  $V_{OUT} = 95\% * V_{OUT(NOM)}$

### ■ SIMPLIFIED BLOCK DIAGRAM:

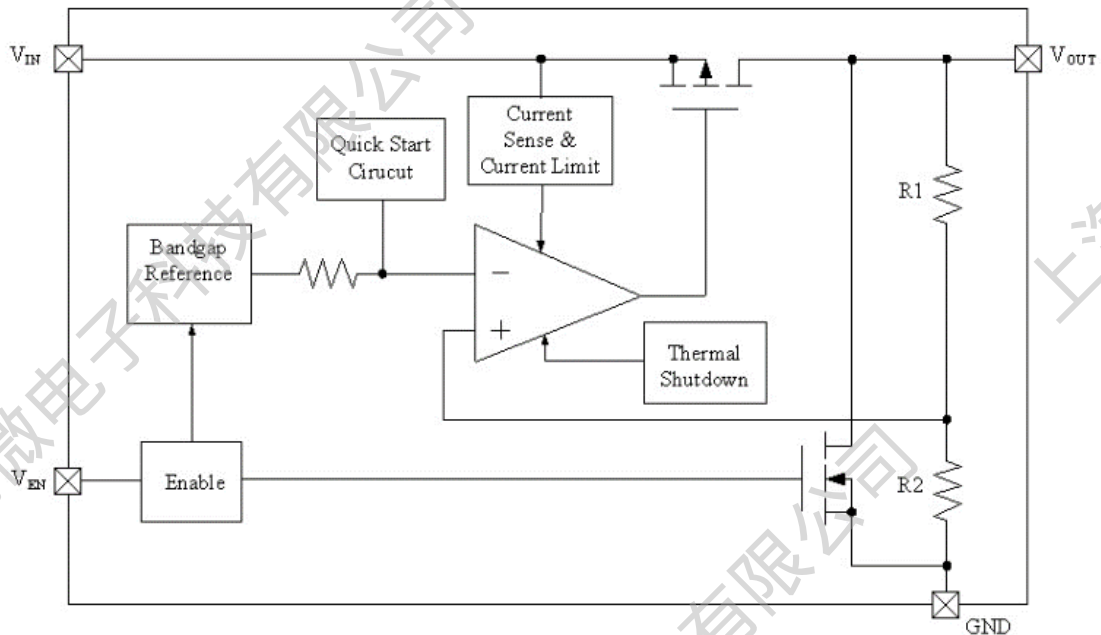

### ■ DETAIL OPERATION DESCRIPTION:

The LW55XX Series is a high PSRR, low drop-out HV voltage regulator. It consists of a current limiter circuit, a driver transistor, a precision voltage reference and an error correction circuit, and is compatible with low ESR ceramic capacitors. The current limiter's fold-back circuit operates as a short circuit protection as well as the output current limiter.

#### **Current Limiting and Short-Circuit Protection**

The current limit circuitry prevents damage to the MOSFET switch and the hub downstream port but can deliver load current up to the current limit threshold through the switch. When a heavy load or short circuit is applied to an enabled switch, a large transient current may flow until the current limit circuitry responds. Once this current limit threshold is exceeded the device enters constant current mode until the thermal shutdown occurs or the fault is removed.

### TYPICAL OPERATING CHARACTERISTICS

(Tested under  $V_{IN}=V_{OUT}+1V$ ,  $V_{OUT}=3.3V$ ,  $C_{IN}=C_{OUT}=1\mu F$ ,  $T_A=25^\circ C$ , unless otherwise specified)

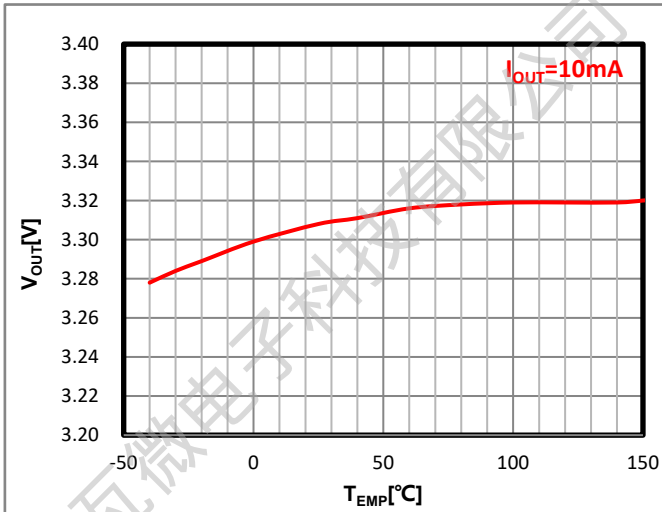

Figure 1.  $V_{OUT}$  vs Temperature

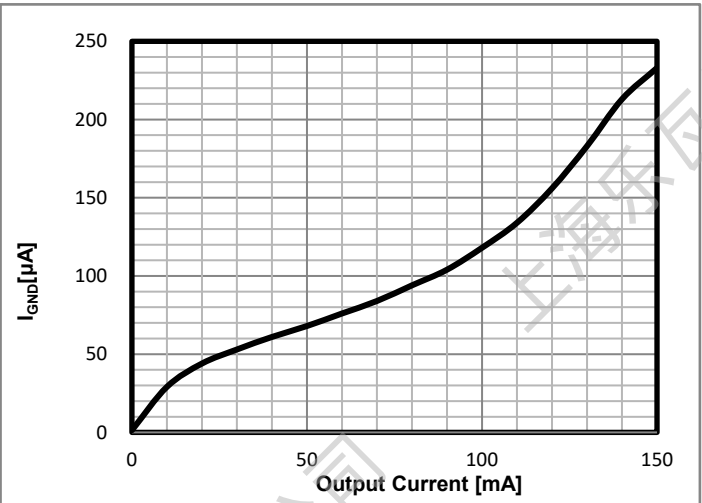

Figure 2. Ground Current vs Output Current

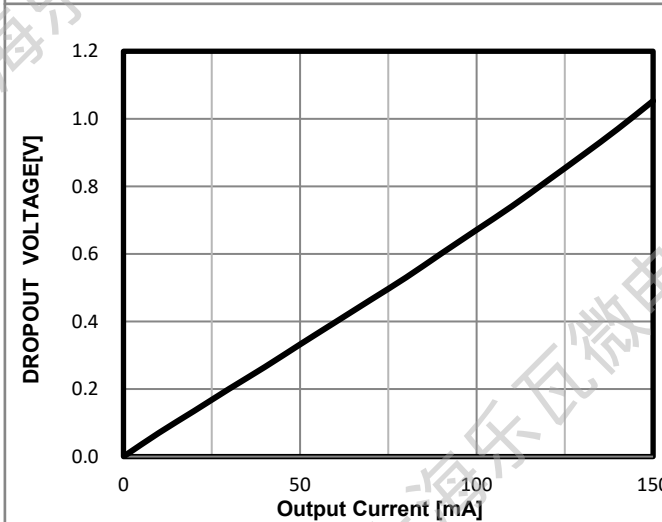

Figure 3. Dropout Voltage vs Output Current

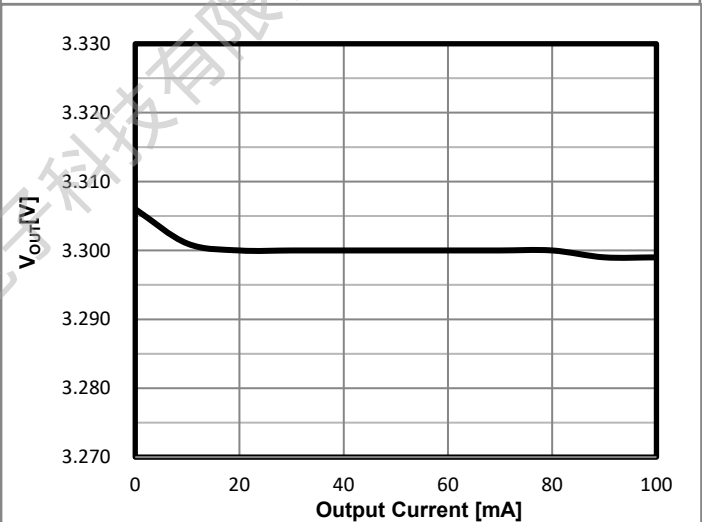

Figure 4. Load Regulation vs Output Current

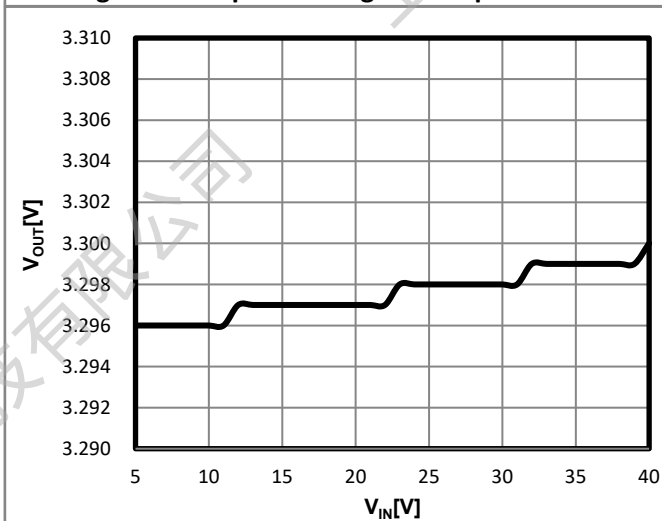

Figure 5. Line Regulation vs  $V_{IN}$

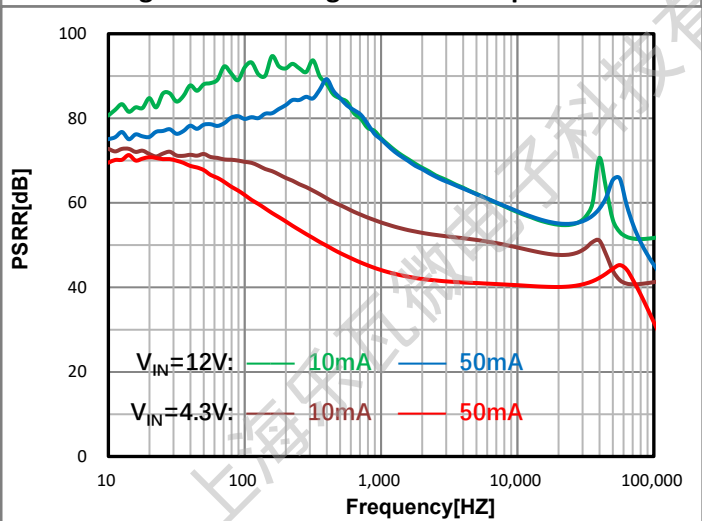
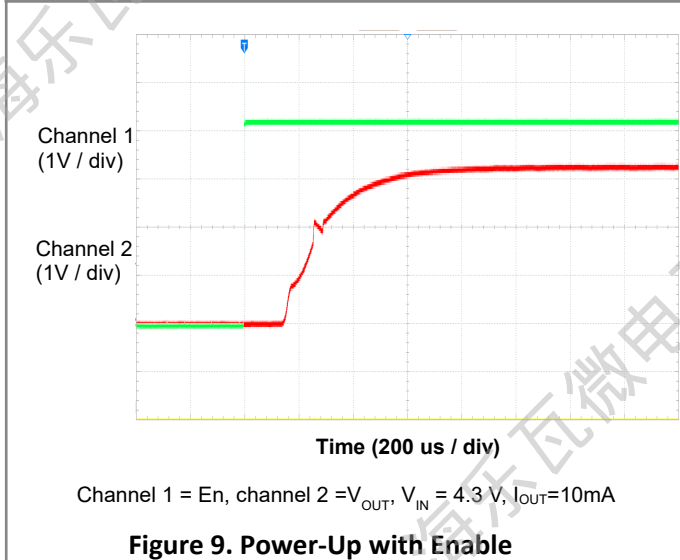
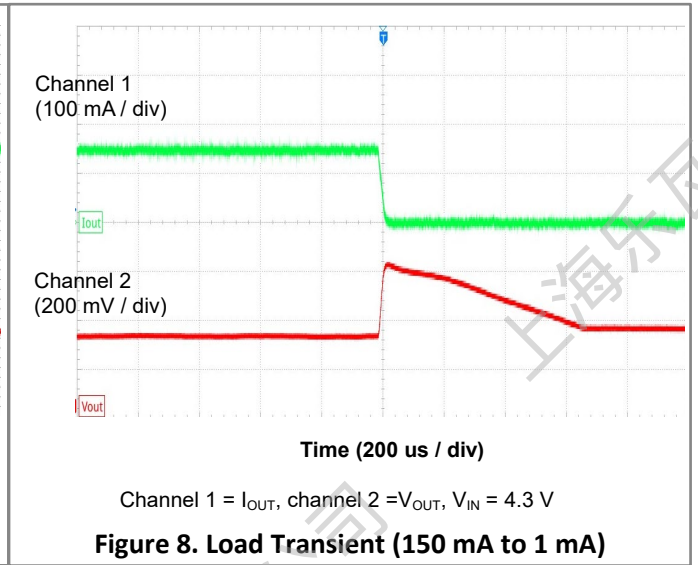
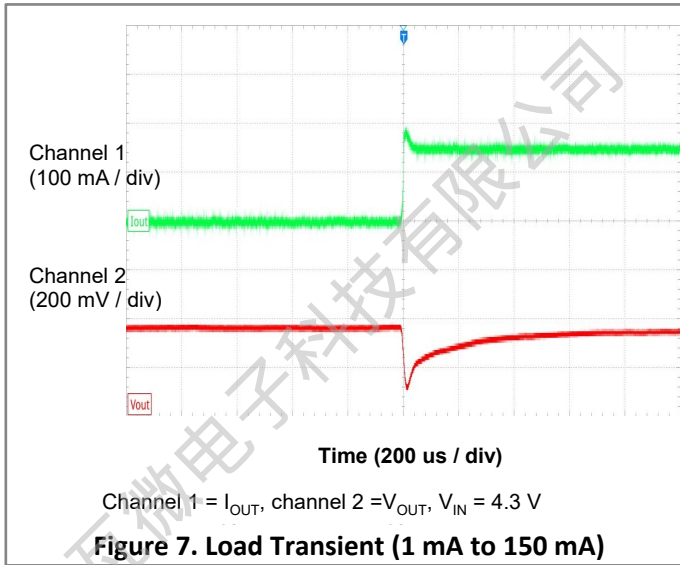

Figure 6. PSRR vs Frequency



### ORDER INFORMATION

LW55①②③④⑤⑥

Designator	Item	Symbol	Description
①②	Output Voltage	18~50	e.g.2.8V→①=2,②=8
③④⑤⑥	Packages	A23D	SOT23-3L
		A23E	SOT23-5A
		B23E	SOT23-5B
		A89C	SOT89-3A
		B89C	SOT89-3B
		A52B	TO-252

Part #	Output Voltage	Package	Shipping
LW5518A23D	1.8V	SOT23-3L	3000 Pcs / Tape & Reel
LW5525A23D	2.5V		
LW5530A23D	3.0V		
LW5533A23D	3.3V		
LW5536A23D	3.6V		
LW5540A23D	4.0V		
LW5542A23D	4.2V		
LW5550A23D	5.0V		
LW5518A23E	1.8V	SOT23-5A	3000 Pcs / Tape & Reel
LW5525A23E	2.5V		
LW5530A23E	3.0V		
LW5533A23E	3.3V		
LW5536A23E	3.6V		
LW5540A23E	4.0V		
LW5542A23E	4.2V		
LW5550A23E	5.0V		
LW5518B23E	1.8V	SOT23-5B	3000 Pcs / Tape & Reel
LW5525B23E	2.5V		
LW5530B23E	3.0V		
LW5533B23E	3.3V		
LW5536B23E	3.6V		
LW5540B23E	4.0V		
LW5542B23E	4.2V		
LW5550B23E	5.0V		



Part #	Output Voltage	Package	Shipping
LW5518A89C	1.8V	SOT89-3A	1000 Pcs / Tape & Reel
LW5525A89C	2.5V		
LW5530A89C	3.0V		
LW5533A89C	3.3V		
LW5536A89C	3.6V		
LW5540A89C	4.0V		
LW5542A89C	4.2V		
LW5550A89C	5.0V		
LW5518B89C	1.8V	SOT89-3B	1000 Pcs / Tape & Reel
LW5525B89C	2.5V		
LW5530B89C	3.0V		
LW5533B89C	3.3V		
LW5536B89C	3.6V		
LW5540B89C	4.0V		
LW5542B89C	4.2V		
LW5550B89C	5.0V		
LW5518A52B	1.8V	TO-252	2500 Pcs / Tape & Reel
LW5525A52B	2.5V		
LW5530A52B	3.0V		
LW5533A52B	3.3V		
LW5536A52B	3.6V		
LW5540A52B	4.0V		
LW5542A52B	4.2V		
LW5550A52B	5.0V		

If customers have special output voltage requirements, please contact us.

### PACKAGE OUTLINE

#### 3-Pin SOT23-3L Package

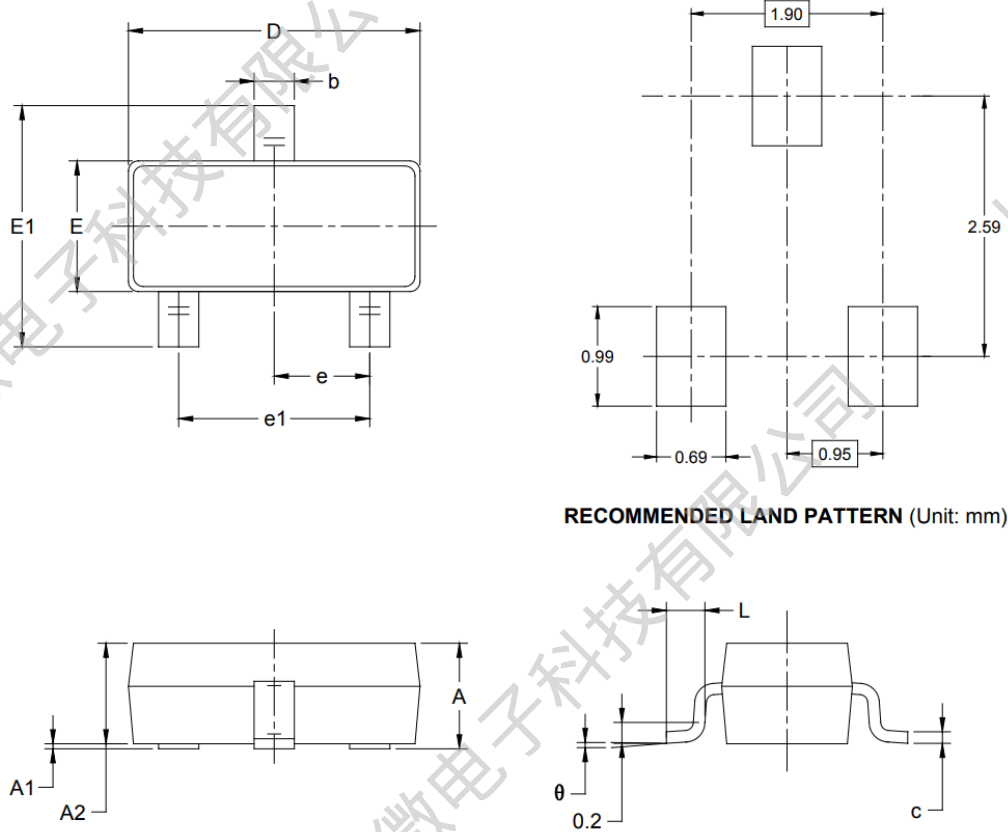

Symbol	Dimensions In Millimeters		Dimensions In Inches	
	MIN	MAX	MIN	MAX
A	1.050	1.250	0.041	0.049
A1	0.000	0.100	0.000	0.004
A2	1.050	1.150	0.041	0.045
b	0.300	0.500	0.012	0.020
c	0.100	0.200	0.004	0.008
D	2.820	3.020	0.111	0.119
E	1.500	1.700	0.059	0.067
E1	2.650	2.950	0.104	0.116
e	0.950 BSC		0.037 BSC	
e1	1.900 BSC		0.075 BSC	
L	0.300	0.600	0.012	0.024
$\theta$	0°	8°	0°	8°

### 5-Pin SOT23-5 Package

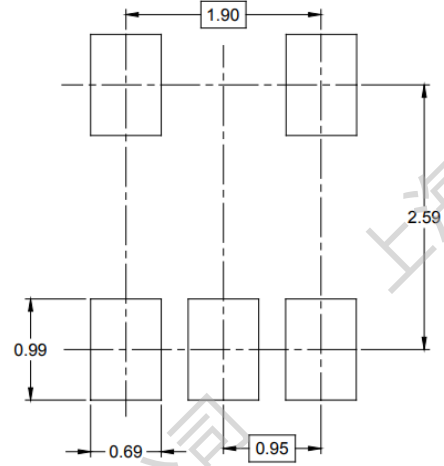
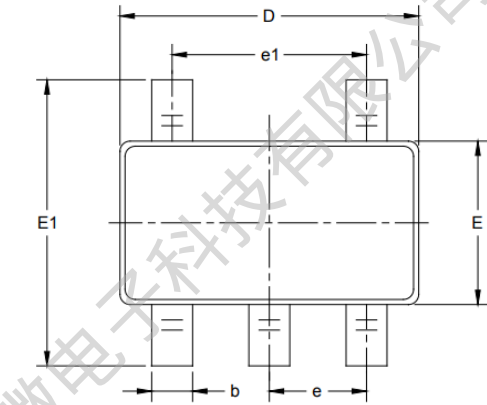

RECOMMENDED LAND PATTERN (Unit: mm)

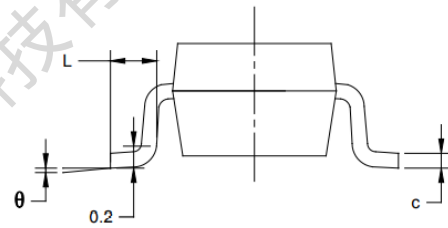
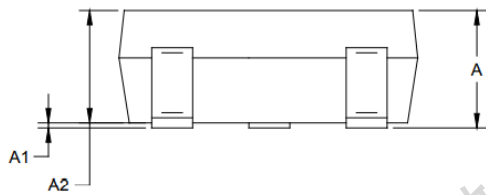

Symbol	Dimensions In Millimeters		Dimensions In Inches	
	MIN	MAX	MIN	MAX
A	1.050	1.250	0.041	0.049
A1	0.000	0.100	0.000	0.004
A2	1.050	1.150	0.041	0.045
b	0.300	0.500	0.012	0.020
c	0.100	0.200	0.004	0.008
D	2.820	3.020	0.111	0.119
E	1.500	1.700	0.059	0.067
E1	2.650	2.950	0.104	0.116
e	0.950 BSC		0.037 BSC	
e1	1.900 BSC		0.075 BSC	
L	0.300	0.600	0.012	0.024
$\theta$	0°	8°	0°	8°

### 3-Pin SOT89-3 Package

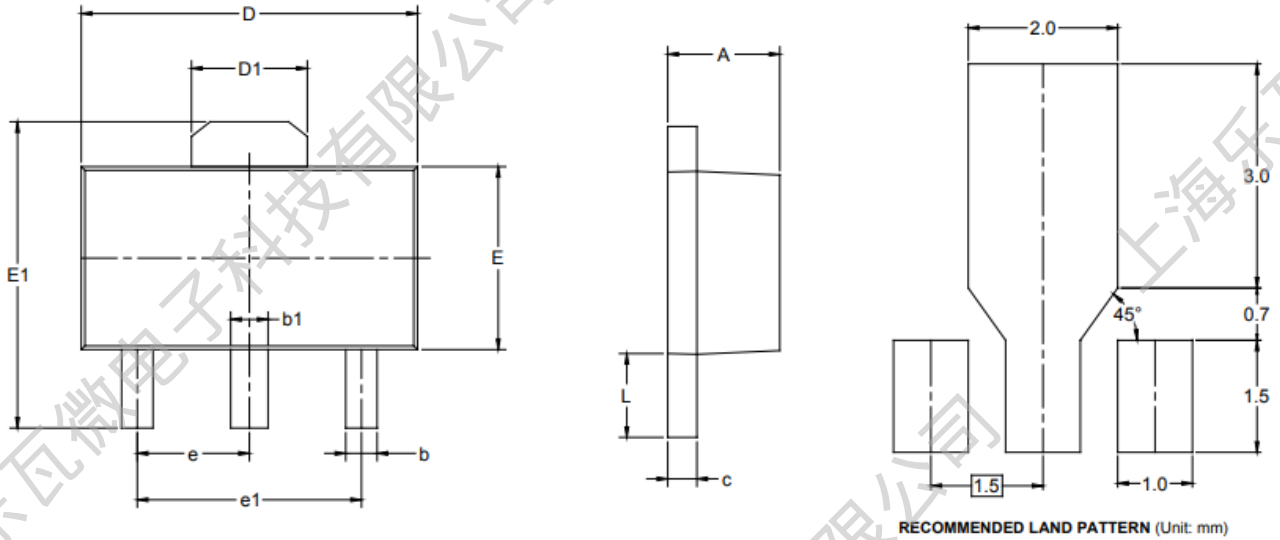

Symbol	Dimensions In Millimeters		Dimensions In Inches	
	MIN	MAX	MIN	MAX
A	1.400	1.600	0.055	0.063
b	0.320	0.520	0.013	0.020
b1	0.400	0.580	0.016	0.023
c	0.350	0.440	0.014	0.017
D	4.400	4.600	0.173	0.181
D1	1.550 REF		0.061 REF	
E	2.300	2.600	0.091	0.102
E1	3.940	4.250	0.155	0.167
e	1.500 TYP		0.060 TYP	
e1	3.000 TYP		0.118 TYP	
L	0.900	1.200	0.035	0.047

### 3-Pin TO-252 Package

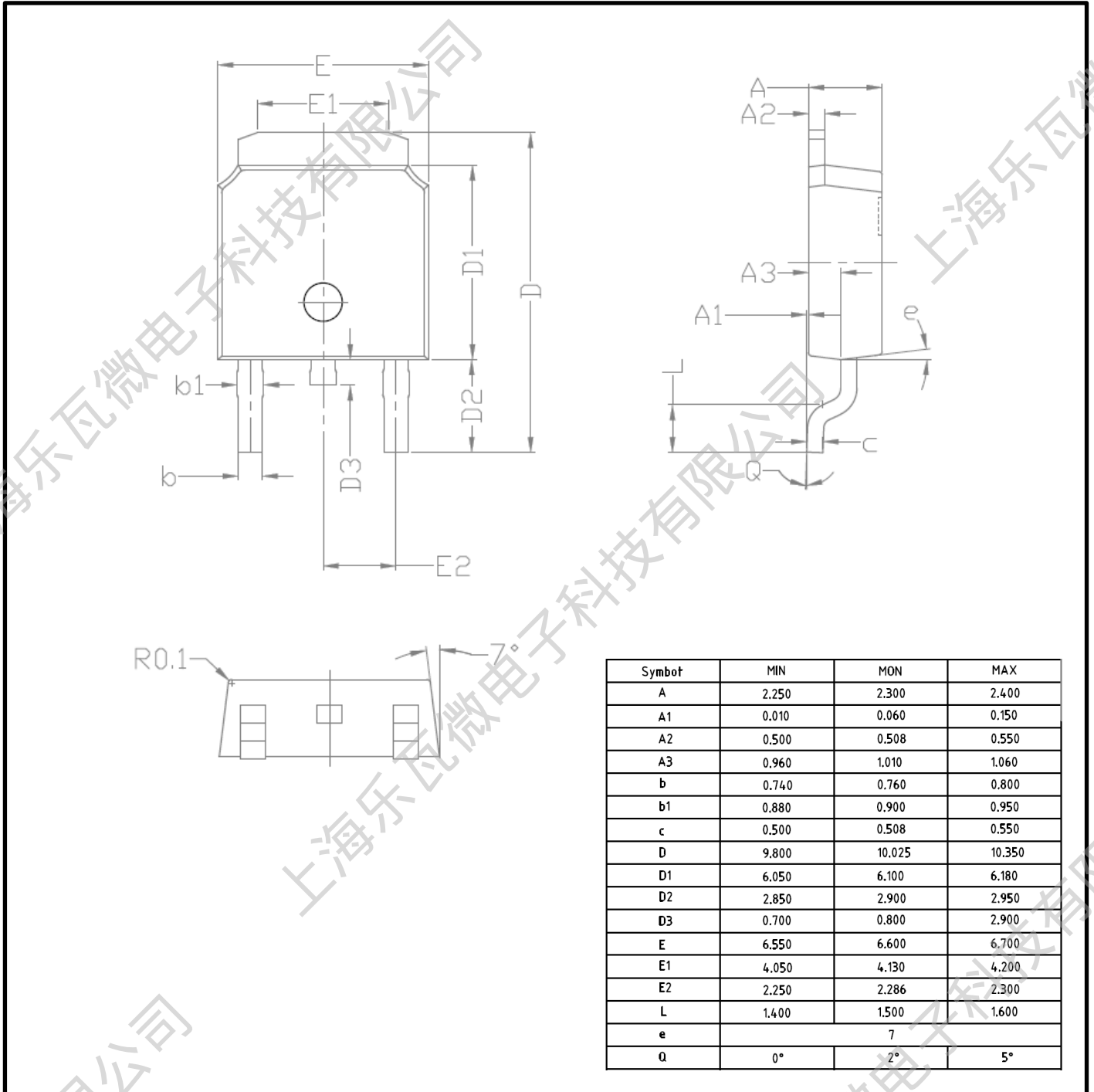

**■ DISCLAIMER:**

The information in this document is believed to be accurate and reliable. However, no responsibility is assumed by LW-Micro for its use. All operating parameters must be designed, validated and tested to ensure they meet the requirements of your application. LW-Micro reserves the right to make any specification and/or circuitry changes without prior notification. Before starting a brand-new project, please contact LW-Micro Sales to get the most recent relevant information.

Mailing Address: Room 301, Building 2, No.1690 CaiLun Road, China (Shanghai) Pilot Free Trade Zone  
Shanghai Lewa Micro-electronics Technology Co., Ltd

## X-ON Electronics

Largest Supplier of Electrical and Electronic Components

*Click to view similar products for [LDO Voltage Regulators](#) category:*

*Click to view products by [Lewa Micro](#) manufacturer:*

Other Similar products are found below :

[AP7363-SP-13](#) [NCV8664CST33T3G](#) [L79M05TL-E](#) [AP7362-HA-7](#) [PT7M8202B12TA5EX](#) [TCR3DF185,LM\(CT](#) [TLF4949EJ](#)  
[NCP4687DH15T1G](#) [NCV8703MX30TCG](#) [LP2951CN](#) [NCV4269CPD50R2G](#) [AP7315-25W5-7](#) [NCV47411PAAJR2G](#) [AP2111H-1.2TRG1](#)  
[ZLDO1117QK50TC](#) [AZ1117ID-ADJTRG1](#) [NCV4263-2CPD50R2G](#) [NCP114BMX075TCG](#) [MC33269T-3.5G](#) [TLE4471GXT](#) [AP7315-33SA-](#)  
[7](#) [NCV4266-2CST33T3G](#) [NCP715SQ15T2G](#) [NCV8623MN-50R2G](#) [NCV563SQ18T1G](#) [NCV8664CDT33RKG](#) [NCV4299CD250R2G](#)  
[NCP715MX30TBG](#) [NCV8702MX25TCG](#) [L974113TR](#) [TLE7270-2E](#) [NCV562SQ25T1G](#) [AP2213D-3.3TRG1](#) [AP2202K-2.6TRE1](#)  
[NCV8170BMX300TCG](#) [NCV8152MX300180TCG](#) [NCP700CMT45TBG](#) [AP7315-33W5-7](#) [LD56100DPU28R](#) [NCP154MX180300TAG](#)  
[AP2210K-3.0TRE1](#) [AP2113AMTR-G1](#) [NJW4104U2-33A-TE1](#) [MP2013AGG-5-P](#) [NCV8775CDT50RKG](#) [NJM2878F3-45-TE1](#) [S-](#)  
[19214B00A-V5T2U7](#) [S-19214B50A-V5T2U7](#) [S-19213B50A-V5T2U7](#) [S-19214BC0A-E8T1U7\\*1](#)