

### ■ GENERATION DESCRIPTION

The LW65XX is a 40V low-power high accuracy LDO regulator. The 2.5 $\mu$ A power consumption makes it ideal for most HV power-saving systems. The maximum operating voltage can be as high as 40V. The output accuracy is as excellent as  $\pm 1.0\%$ .

The other features include low dropout voltage, current limiting protection and thermal shutdown protection.

The LW65XX is available in SOT23-3L, SOT23-5L and SOT89-3 packages.

### ■ APPLICATIONS

- Battery Supplied Systems
- Telecom Systems
- Audio & Video Devices

### ■ TYPICAL APPLICATION CIRCUIT

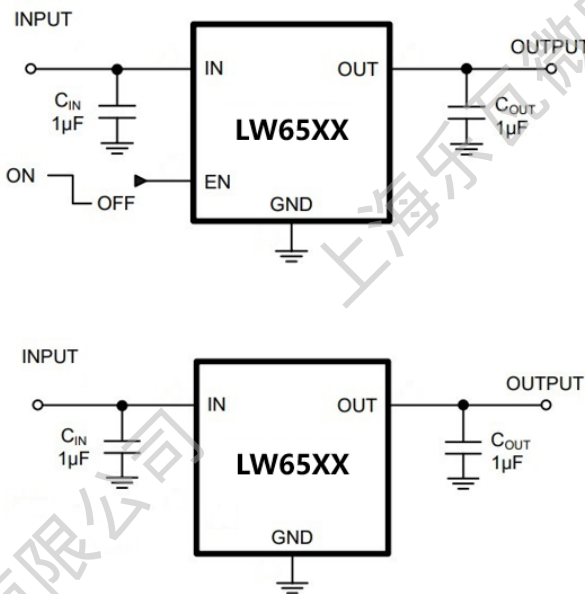

### ■ FEATURES

- Maximum Operating Voltage: 40V
- Output Voltage: 1.5V~5.0V, step=100mV
- Output Accuracy:  $\pm 1.0\%$
- Low Power Consumption: 2.5 $\mu$ A
- <0.2 $\mu$ A Standby Current
- Current Limiting, Thermal Shutdown
- Available in SOT23-3L, SOT23-5L and SOT89-3 Packages

### ■ TYPICAL PERFORMANCE CHARACTERISTICS

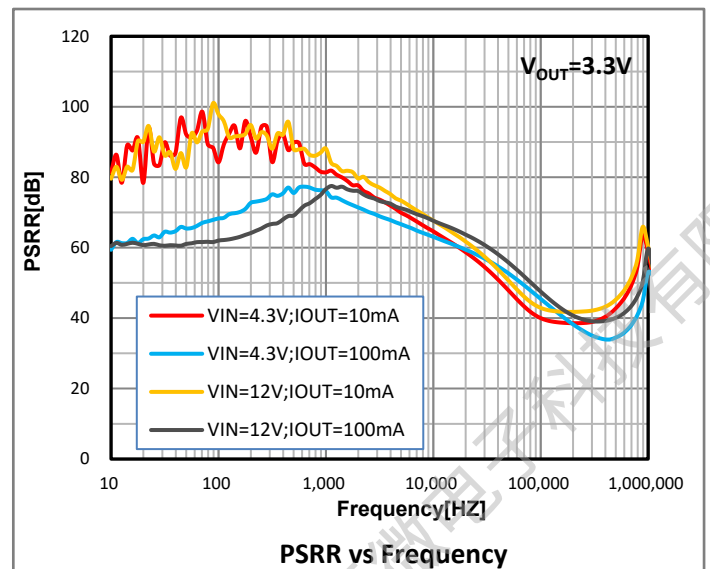

### PIN DESCRIPTION

PIN No				SYMBOL	DESCRIPTION
SOT23-3L	SOT23-5L	SOT89-3A	SOT89-3B		
1	2	1	2	GND	Ground
2	5	3	1	VOUT	Output
3	1	2	3	VIN	Power Supply Input
-	3	-	-	EN	Chip Enable
-	4	-	-	NC	Not Connected

### PIN ASSIGNMENT

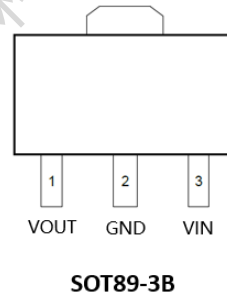
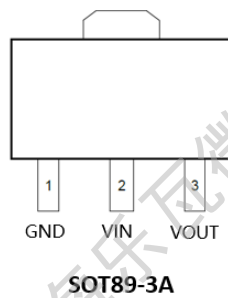
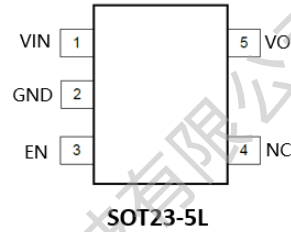
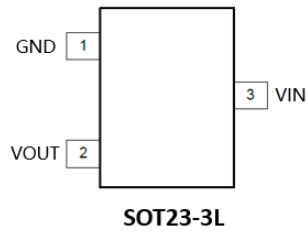

### MARK INFORMATION:

**SOT23-3L, SOT23-5L, SOT89-3**

**XX: VOLTAGE**

**YY: DATE CODE**

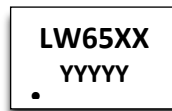

### ABSOLUTE MAXIMUM RATINGS <sup>(1)</sup>

(T<sub>A</sub> =25°C, unless otherwise specified.)

Symbol	Item	Rating	Unit	
V <sub>IN</sub>	Supply Voltage	-0.3~44	V	
V <sub>EN</sub>	EN pin to GND Voltage	-0.3~44	V	
V <sub>OUT</sub>	VOUT pin to GND Voltage	-0.3~6.0	V	
V <sub>(ESD)</sub>	ESD Susceptibility, HBM <sup>(2)</sup>	±2000	V	
P <sub>D</sub>	Maximum Power Dissipation	SOT23-3L	0.43	W
		SOT23-5L	0.45	W
		SOT89-3	1.0	W
R <sub>θJA</sub>	Junction-to-ambient Thermal Resistance	SOT23-3L	283	°C/W
		SOT23-5L	278	°C/W
		SOT89-3	125	°C/W
T <sub>J</sub>	Junction Temperature Range	-40~150	°C	
T <sub>STG</sub>	Storage Temperature Range	-40~150	°C	
T <sub>SOLDER</sub>	Lead Temperature (Soldering)	260°C, 10s		

**Note:**

1. Stresses beyond those listed under Absolute Maximum Ratings may cause permanent damage to the device. These are stress ratings only, and functional operation of the device at these or any other conditions beyond those indicated under Recommended Operating Conditions is not implied. Exposure to absolute-maximum-rated conditions for extended periods may affect device reliability

2. per ANSI/ESDA/JEDEC JS-001

### RECOMMENDED OPERATING RANGE:

SYMBOL	ITEM	VALUE	UNIT
V <sub>IN</sub>	VIN Supply Voltage	2.5~40	V
V <sub>EN</sub>	EN Pin Voltage	0~40	V
V <sub>OUT</sub>	VOUT Pin Voltage	1.5~5.0	V
I <sub>OUT</sub>	Output Current	0~150	mA
T <sub>J</sub>	Junction Temperature Range	-40~125	°C

### ■ ELECTRICAL CHARACTERISTICS

( $V_{IN}=V_{OUT}+1V$ ,  $V_{OUT}=3.3V$ ,  $C_{IN}=C_{OUT}=1\mu F$ ,  $T_A=25^\circ C$ , unless otherwise specified.)

Symbol	Parameter	Test Conditions	MIN	TYP	MAX	Units
$V_{IN}$	Input Voltage		2.5		40	V
$V_{OUT}$	Output Accuracy	$I_{OUT}=1mA$	-1.0		+1.0	%
$I_{LIM}$	Current Limit	$V_{IN}=4.3V$ , $V_{OUT}=3.3V$	150	210		mA
$I_Q$	Quiescent Current	$V_{IN}=V_{EN}=V_{OUT}+1V$ , No Load	$V_{OUT}<1.8V$	3.0	4.0	$\mu A$
			$V_{OUT}\geq 1.8V$	2.5	3.5	
$I_{SHD}$	Shutdown Current	$V_{IN}=12V$ , $V_{EN}=0V$		0.1	0.2	$\mu A$
$V_{DROP}$	Dropout Voltage <sup>(1)</sup>	$I_{OUT}=100mA$ , $V_{OUT}=1.8V$		700		mV
		$I_{OUT}=100mA$ , $V_{OUT}=3.3V$		450		
		$I_{OUT}=100mA$ , $V_{OUT}=5.0V$		360		
$S_{LINE}$	Line Regulation	$V_{IN}=V_{OUT}+1V$ to 40V, $I_{OUT}=1mA$		0.02	0.05	%/V
$S_{LOAD}$	Load Regulation	$1mA\leq I_{OUT}\leq 150mA$		0.002	0.005	%/mA
$I_{SHORT}$	Short Current	$V_{OUT}=0V$		15		mA
$V_{ENH}$	EN High Voltage	$V_{IN}=2.5V$ to 40V, $I_{OUT}=1mA$	1.5			V
$V_{ENL}$	EN Low Voltage				0.5	V
PSRR	Power Supply Rejection Ratio	$V_{IN}=5.0V$ , $C_{IN}=None$ , $I_{OUT}=10mA$	$f=217Hz$	86		dB
			$f=1KHz$	81		
			$f=10KHz$	64		
			$f=100KHz$	40		
$T_{SD}$	Overheat Protection	Temperature rising		165		$^\circ C$
$\Delta T_{SD}$	TSD Hysteresis	Temperature falling		15		$^\circ C$
$R_{DSCHG}$	$R_{ON}$ of $V_{OUT}$ Discharge MOSFET	$V_{IN}=12V$ , $V_{OUT}=5.0V$ , $V_{EN}=0V$		130		$\Omega$

#### NOTES:

- The dropout voltage is defined as  $V_{IN} - V_{OUT}$ , when  $V_{OUT}=95\%*V_{OUT(NOM)}$



### ■ TYPICAL OPERATING CHARACTERISTICS:

(Tested under  $V_{IN}=V_{OUT}+1V$ ,  $C_{IN}=C_{OUT}=1\mu F$ ,  $T_A=25^\circ C$ , unless otherwise specified)

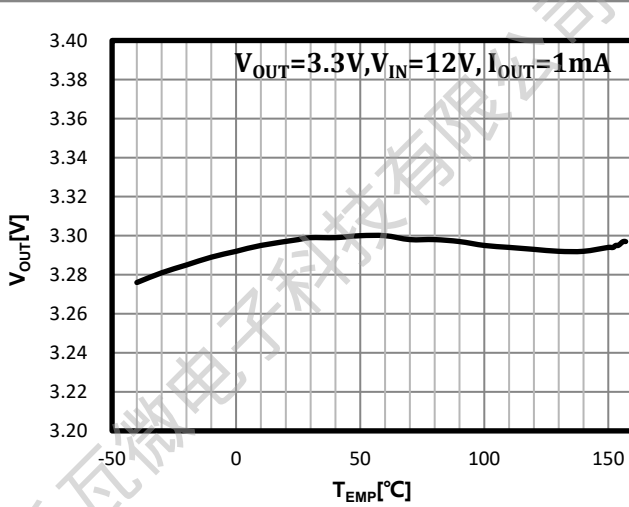

Figure 1.  $V_{OUT}$  vs Temperature

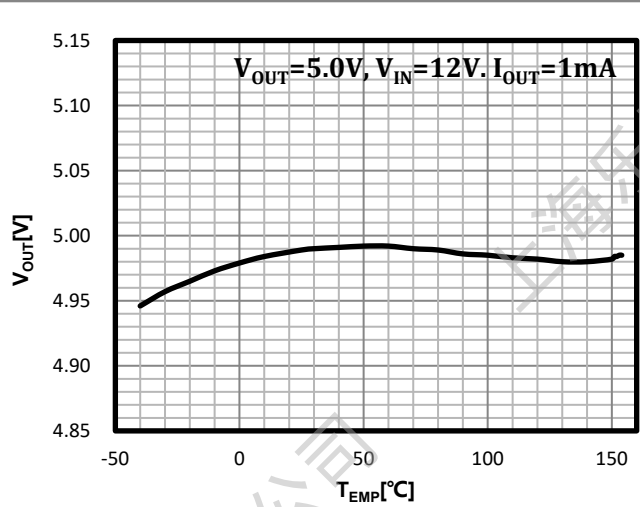

Figure 2.  $V_{OUT}$  vs Temperature

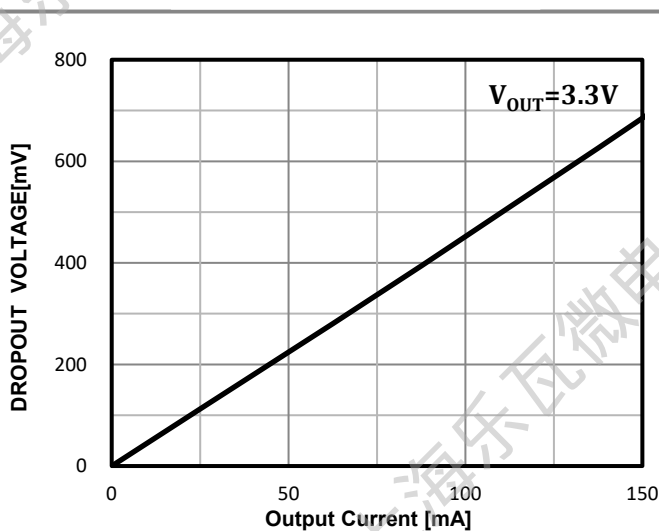

Figure 3. Dropout Voltage vs Output Current

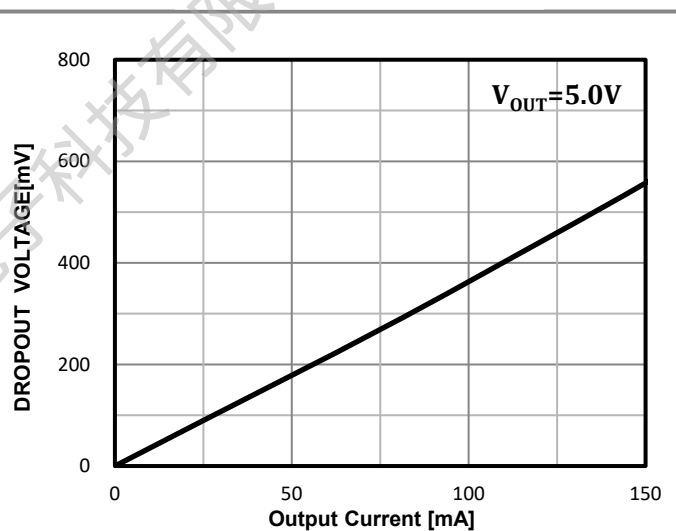

Figure 4. Dropout Voltage vs Output Current

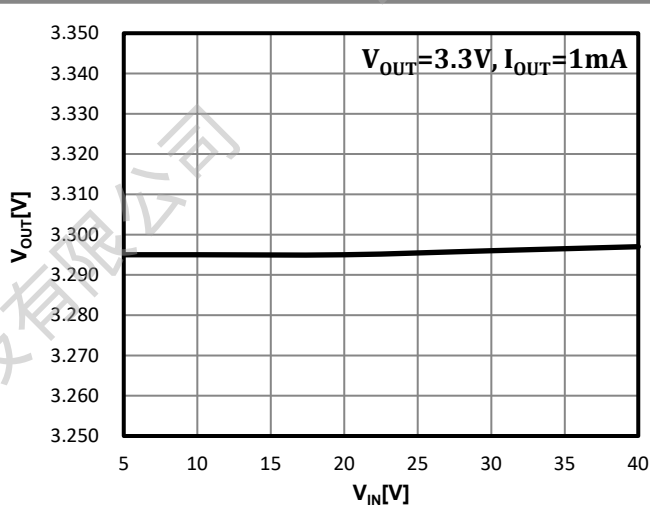

Figure 5. Line Regulation vs  $V_{IN}$

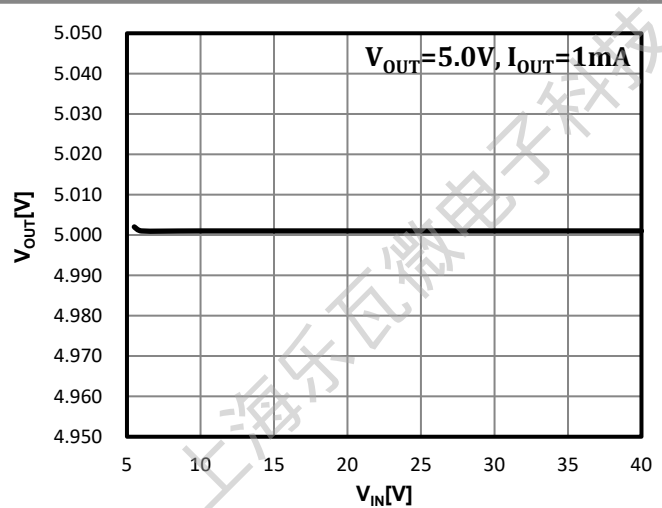
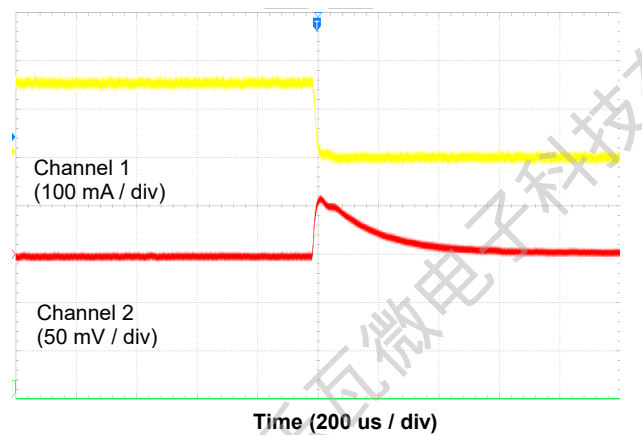
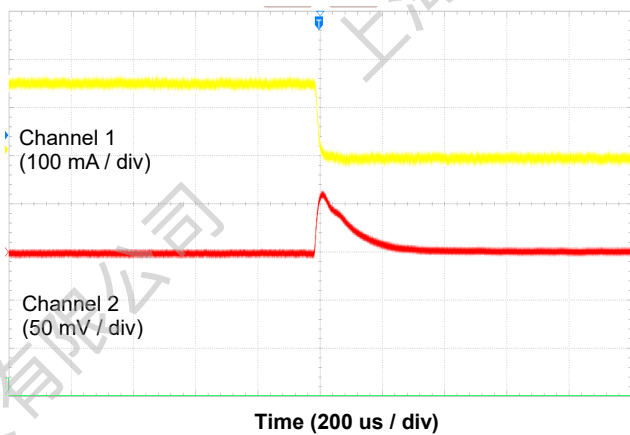
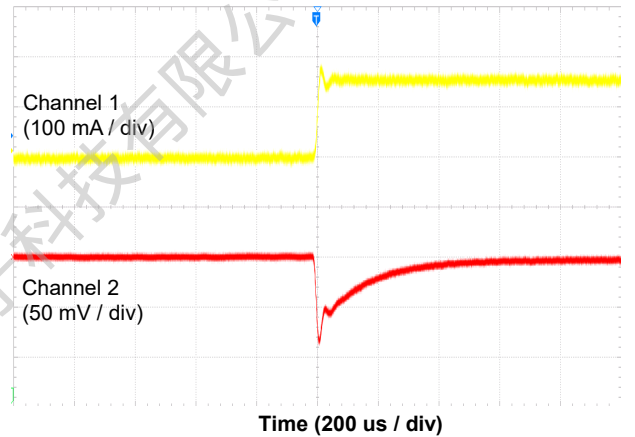
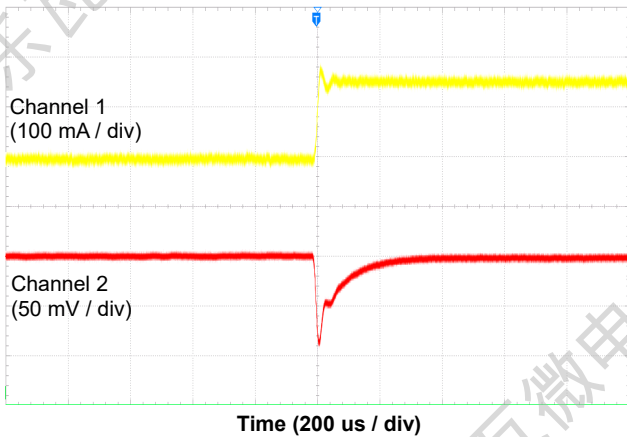
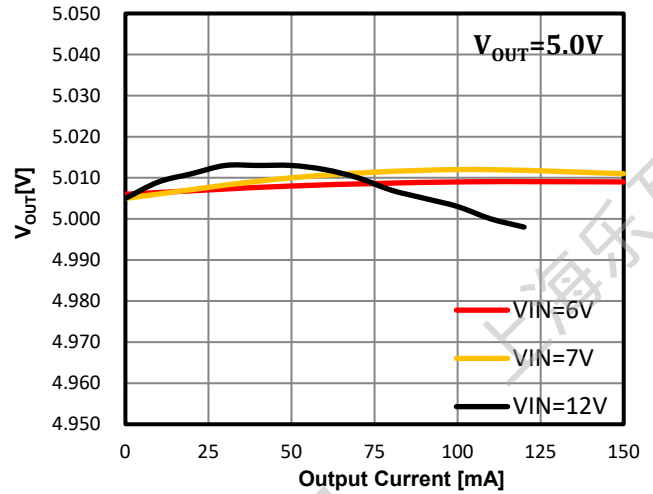
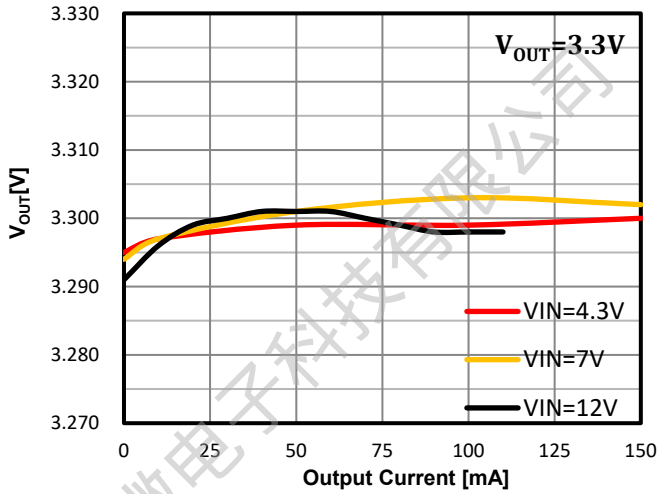
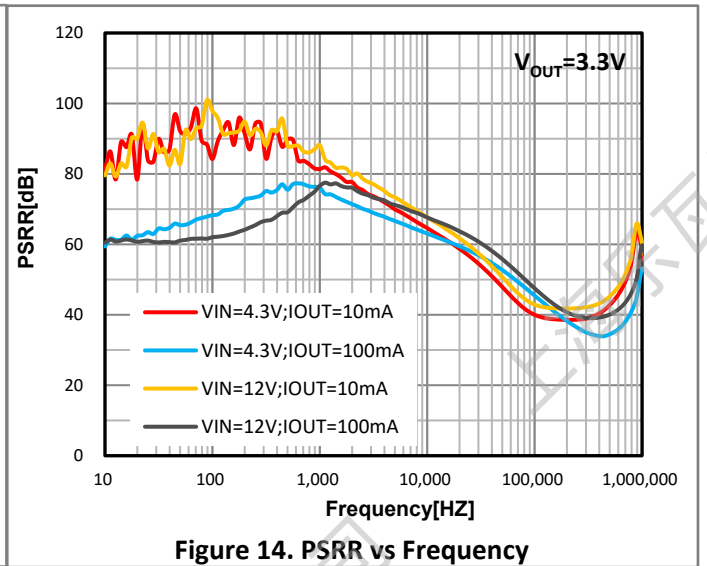
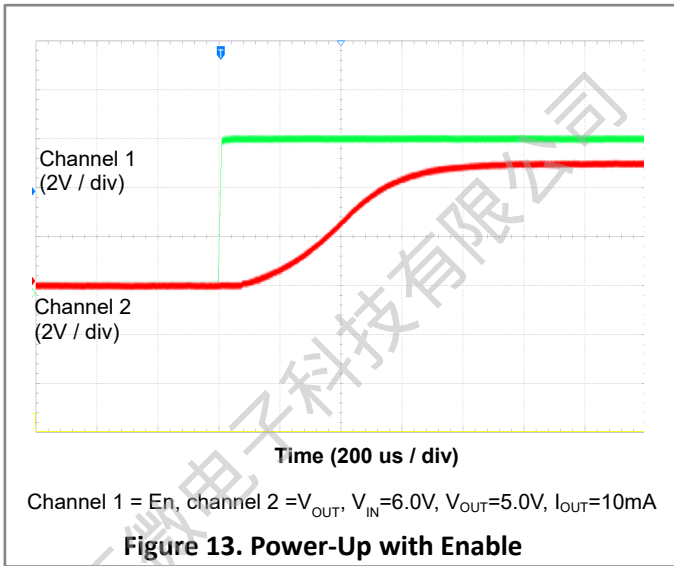

Figure 6. Line Regulation vs  $V_{IN}$







### ORDER INFORMATION

LW65①②③④⑤⑥

Designator	Item	Symbol	Description
①②	Output Voltage	18~50	e.g.2.8V→①=2,②=8
③④⑤⑥	Packages	A23D	SOT23-3L
		A23E	SOT23-5L
		A89C	SOT89-3A
		B89C	SOT89-3B

Part #	Output Voltage	Package	Shipping
LW6518A23D	1.8V	SOT23-3L	3000 Pcs / Tape & Reel
LW6525A23D	2.5V		
LW6530A23D	3.0V		
LW6533A23D	3.3V		
LW6536A23D	3.6V		
LW6540A23D	4.0V		
LW6542A23D	4.2V		
LW6550A23D	5.0V		
LW6518A23E	1.8V	SOT23-5L	3000 Pcs / Tape & Reel
LW6525A23E	2.5V		
LW6530A23E	3.0V		
LW6533A23E	3.3V		
LW6536A23E	3.6V		
LW6540A23E	4.0V		
LW6542A23E	4.2V		
LW6550A23E	5.0V		
LW6518A89C	1.8V	SOT89-3A	1000 Pcs / Tape & Reel
LW6525A89C	2.5V		
LW6530A89C	3.0V		
LW6533A89C	3.3V		
LW6536A89C	3.6V		
LW6540A89C	4.0V		
LW6542A89C	4.2V		
LW6550A89C	5.0V		

Part #	Output Voltage	Package	Shipping
LW6518B89C	1.8V	SOT89-3B	1000 Pcs / Tape & Reel
LW6525B89C	2.5V		
LW6530B89C	3.0V		
LW6533B89C	3.3V		
LW6536B89C	3.6V		
LW6540B89C	4.0V		
LW6542B89C	4.2V		
LW6550B89C	5.0V		

If customers have special output voltage requirements, please contact us.

### PACKAGE OUTLINE

#### 3-Pin SOT23-3L Package

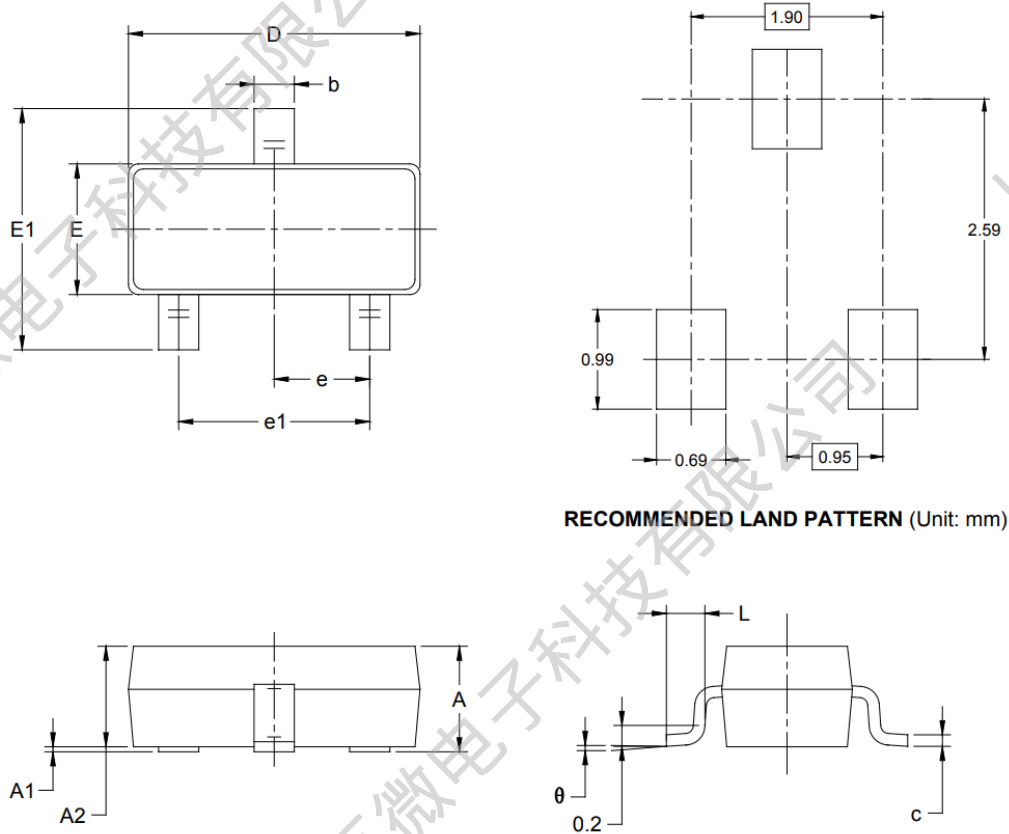

Symbol	Dimensions In Millimeters		Dimensions In Inches	
	MIN	MAX	MIN	MAX
A	1.050	1.250	0.041	0.049
A1	0.000	0.100	0.000	0.004
A2	1.050	1.150	0.041	0.045
b	0.300	0.500	0.012	0.020
c	0.100	0.200	0.004	0.008
D	2.820	3.020	0.111	0.119
E	1.500	1.700	0.059	0.067
E1	2.650	2.950	0.104	0.116
e	0.950 BSC		0.037 BSC	
e1	1.900 BSC		0.075 BSC	
L	0.300	0.600	0.012	0.024
$\theta$	0°	8°	0°	8°

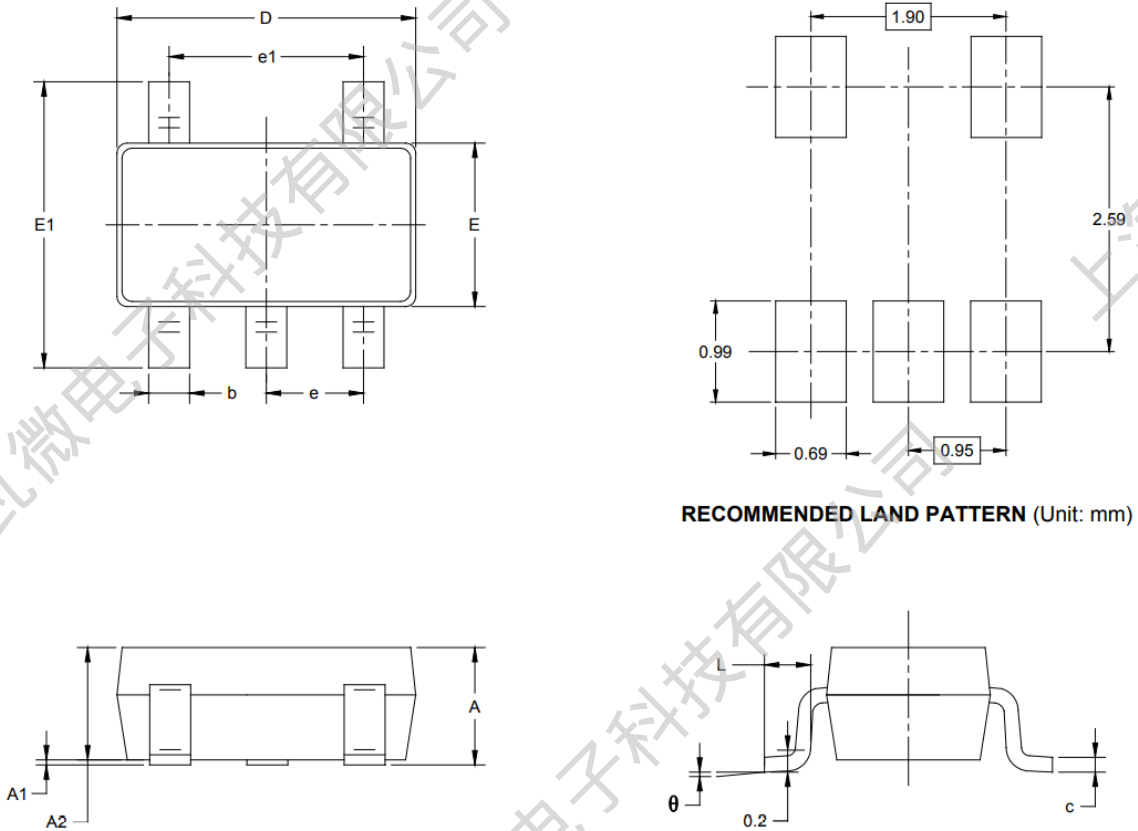
**5-Pin SOT23-5L Package**

Symbol	Dimensions In Millimeters		Dimensions In Inches	
	MIN	MAX	MIN	MAX
A	1.050	1.250	0.041	0.049
A1	0.000	0.100	0.000	0.004
A2	1.050	1.150	0.041	0.045
b	0.300	0.500	0.012	0.020
c	0.100	0.200	0.004	0.008
D	2.820	3.020	0.111	0.119
E	1.500	1.700	0.059	0.067
E1	2.650	2.950	0.104	0.116
e	0.950 BSC		0.037 BSC	
e1	1.900 BSC		0.075 BSC	
L	0.300	0.600	0.012	0.024
θ	0°	8°	0°	8°

### 3-Pin SOT89-3 Package

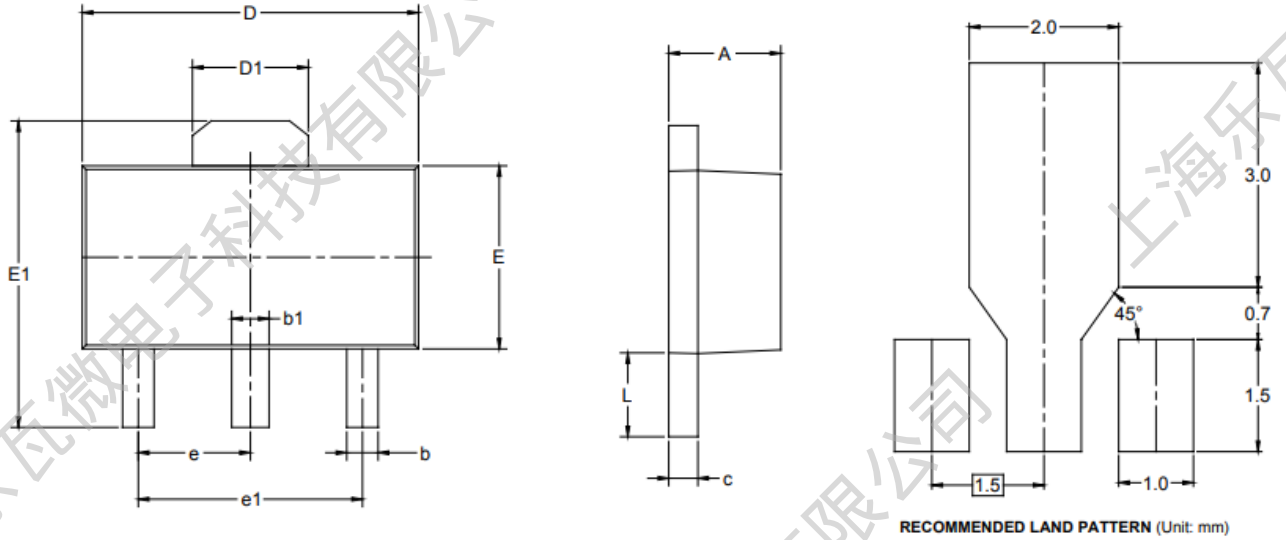

Symbol	Dimensions In Millimeters		Dimensions In Inches	
	MIN	MAX	MIN	MAX
A	1.400	1.600	0.055	0.063
b	0.320	0.520	0.013	0.020
b1	0.400	0.580	0.016	0.023
c	0.350	0.440	0.014	0.017
D	4.400	4.600	0.173	0.181
D1	1.550 REF		0.061 REF	
E	2.300	2.600	0.091	0.102
E1	3.940	4.250	0.155	0.167
e	1.500 TYP		0.060 TYP	
e1	3.000 TYP		0.118 TYP	
L	0.900	1.200	0.035	0.047

**REVISION HISTORY**

Revision	Date	Descriptions
Rev 0.1	Dec.2022	Initial Version
Rev 0.2	Jun.2023	Update Electrical Characteristics
Rev 1.0	Nov.2023	Formal Version Release

**■ DISCLAIMER:**

The information in this document is believed to be accurate and reliable. However, no responsibility is assumed by LW-Micro for its use. All operating parameters must be designed, validated and tested to ensure they meet the requirements of your application. LW-Micro reserves the right to make any specification and/or circuitry changes without prior notification. Before starting a brand-new project, please contact LW-Micro Sales to get the most recent relevant information.

Mailing Address: Room 301, Building 2, No.1690 CaiLun Road, China (Shanghai) Pilot Free Trade Zone  
Shanghai Lewa Micro-electronics Technology Co., Ltd

## X-ON Electronics

Largest Supplier of Electrical and Electronic Components

*Click to view similar products for [LDO Voltage Regulators](#) category:*

*Click to view products by [Lewa Micro](#) manufacturer:*

Other Similar products are found below :

[AP7363-SP-13](#) [NCV8664CST33T3G](#) [L79M05TL-E](#) [AP7362-HA-7](#) [PT7M8202B12TA5EX](#) [TCR3DF185,LM\(CT](#) [TLF4949EJ](#)  
[NCP4687DH15T1G](#) [NCV8703MX30TCG](#) [LP2951CN](#) [NCV4269CPD50R2G](#) [AP7315-25W5-7](#) [NCV47411PAAJR2G](#) [AP2111H-1.2TRG1](#)  
[ZLDO1117QK50TC](#) [AZ1117ID-ADJTRG1](#) [NCV4263-2CPD50R2G](#) [NCP114BMX075TCG](#) [MC33269T-3.5G](#) [TLE4471GXT](#) [AP7315-33SA-](#)  
[7](#) [NCV4266-2CST33T3G](#) [NCP715SQ15T2G](#) [NCV8623MN-50R2G](#) [NCV563SQ18T1G](#) [NCV8664CDT33RKG](#) [NCV4299CD250R2G](#)  
[NCP715MX30TBG](#) [NCV8702MX25TCG](#) [L974113TR](#) [TLE7270-2E](#) [NCV562SQ25T1G](#) [AP2213D-3.3TRG1](#) [AP2202K-2.6TRE1](#)  
[NCV8170BMX300TCG](#) [NCV8152MX300180TCG](#) [NCP700CMT45TBG](#) [AP7315-33W5-7](#) [LD56100DPU28R](#) [NCP154MX180300TAG](#)  
[AP2210K-3.0TRE1](#) [AP2113AMTR-G1](#) [NJW4104U2-33A-TE1](#) [MP2013AGG-5-P](#) [NCV8775CDT50RKG](#) [NJM2878F3-45-TE1](#) [S-](#)  
[19214B00A-V5T2U7](#) [S-19214B50A-V5T2U7](#) [S-19213B50A-V5T2U7](#) [S-19214BC0A-E8T1U7\\*1](#)