



FEATURES



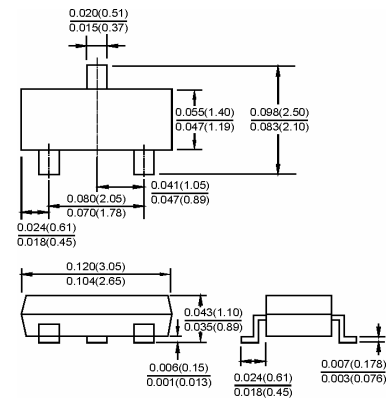

- ◇ Fast switching speed.
- ◇ Surface mount package ideally suited for
- ◇ Automatic insertion.
- ◇ For general purpose switching applications.
- ◇ High conductance.

APPLICATIONS

- ◇ High speed switching application.

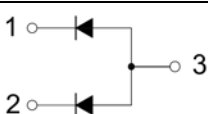
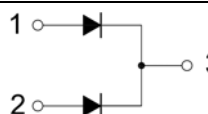
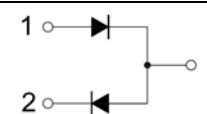

Dimensions in inches and (millimeters)

BAV23A	BAV23C	BAV23S
		
MARKING: KT7	MARKING: KT6	MARKING: KL31
		

MAXIMUM RATING @ Ta=25. unless otherwise specified

Characteristic	Symbol	Value	Unit
Repetitive Peak Reverse Voltage	V_{RRM}	250	V
Working peak reverse voltage DC reverse voltage	V_{RWM} V_R	200	V
RSM Reverse Voltage	$V_{R(RMS)}$	141	V
Forward Continuous Current(Max.)	I_{FM}	400	mA
Non-Repetitive Peak Forward Surge Current @ t = 1.0μs @ t = 100μs @ t = 10ms	I_{FSM}	9.0 3.0 1.7	A
Repetitive Peak Forward Surge Current	I_{FRM}	625	mA
Power Dissipation	P_d	350	mW
Thermal Resistance Junction to Ambient Air	$R_{\theta JA}$	357	°C/W
Operating Junction Temperature Range	T_j	150	°C
Storage Temperature Range	T_{STG}	-65 to +150	°C

ELECTRICAL CHARACTERISTICS @ Ta=25. unless otherwise specified

Characteristic	Symbol	Min	MAX	UNIT	Test Condition
Reverse breakdown Voltage	$V_{(BR)R}$	250	-	V	$I_R=100\mu A$
Reverse Leakage Current	I_R	-	100	nA	$V_R=200V$
Forward voltage	V_F	-	1 1.25	V	$I_F=100mA$ $I_F=200mA$
Total Capacitance	C_T	-	5.0	pF	$V_R=0V, f=1.0MHz$
Reverse Recovery Time	t_{rr}	-	50	ns	$I_F=I_R=30mA, t_r=0.1 \cdot I_R$ $R_L=100\Omega$

TYPICAL CHARACTERISTICS @ Ta=25. unless otherwise specified

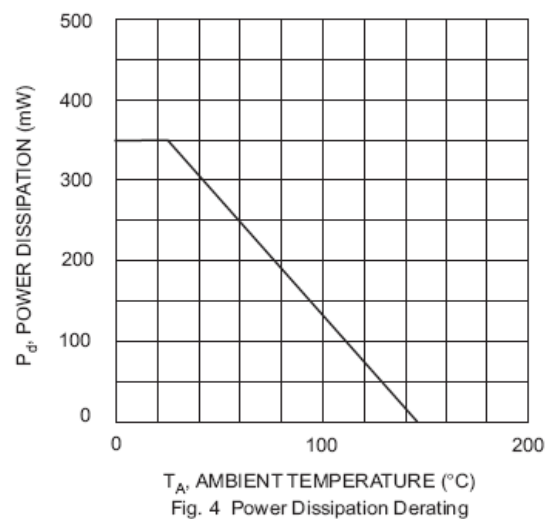
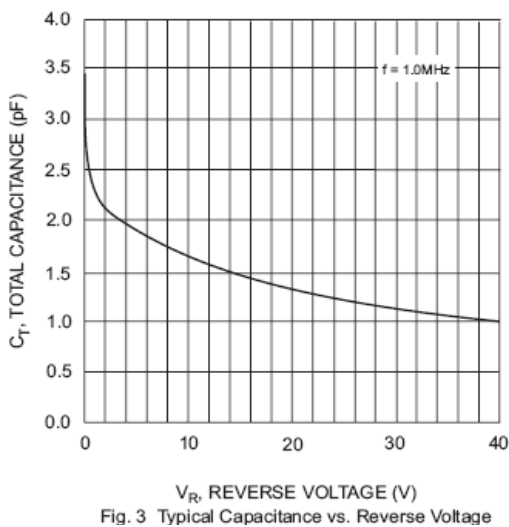
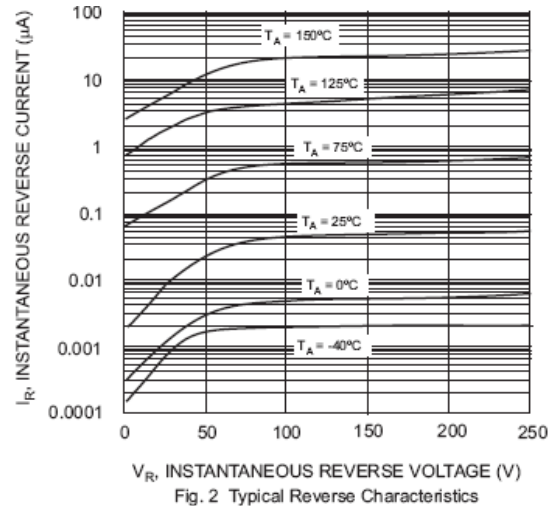
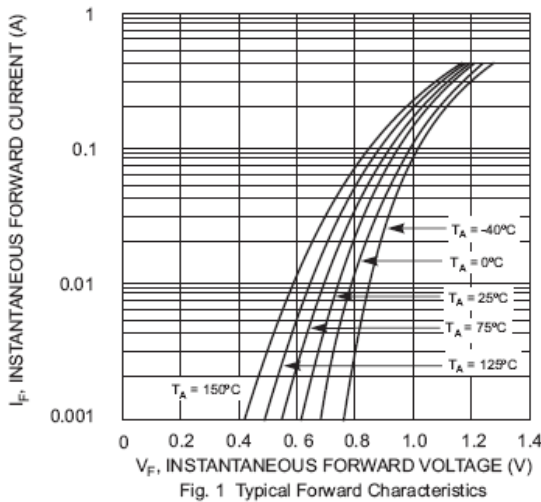

PACKAGE	SPQ/PCS	CARTON SPQ/PCS	CARTON SIZE/CM	CARTON GW/KG	CARTON NW/KG
SOT-23	3000/REEL	90000	40X20X22	5.00	4.00

X-ON Electronics

Largest Supplier of Electrical and Electronic Components

Click to view similar products for [Diodes - General Purpose, Power, Switching category](#):

Click to view products by [LGE manufacturer](#):

Other Similar products are found below :

[MCL4151-TR3](#) [MMBD3004S-13-F](#) [RD0306T-H](#) [1N3611](#) [NTE156A](#) [NTE574](#) [NTE6244](#) [1SS193,LF](#) [1SS400CST2RA](#) [SDAA13](#)
[SHN2D02FUTW1T1G](#) [LS4151GS08](#) [1N4449](#) [1N456A](#) [1N4934-E3/73](#) [1N914BTR](#) [RFUH20TB3S](#) [D291S45T](#) [BAV300-TR](#) [BAW56DWQ-](#)
[7-F](#) [BAW56M3T5G](#) [BAW75-TAP](#) [MM230L-CAA](#) [IDW40E65D1](#) [JAN1N3600](#) [JAN1N4454UR-1](#) [LL4151-GS18](#) [SMMSD4148T3G](#)
[BYW95B/A52A](#) [NSVDAN222T1G](#) [CDSZC01100-HF](#) [LL4150-M-08](#) [1N4454-TR](#) [BAV70HDW-7](#) [BAS28-7](#) [JANTX1N6640](#) [BAW56HDW-](#)
[13](#) [BAS28 TR](#) [VS-HFA04SD60STR-M3](#) [NSVM1MA152WKT1G](#) [1SS388-TP](#) [RGP30D-E3/73](#) [VS-8EWF02S-M3](#) [BAV99TQ-13-F](#)
[BAV99HDW-13](#) [MMDB30-E28X](#) [IDP20C65D2XKSA1](#) [LS4148](#) [IDV15E65D2](#) [NSVM1MA152WAT1G](#)