

3: cathode

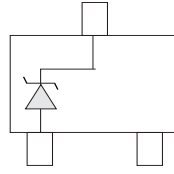

1: ANODE 2

C: 5% tolerance

SOT-23

Features

- Planar Die Construction.
- 350mw Power Dissipation.
- Zener Voltages From 2.4V -51V
- Ideally Suited For Automated Assembly Processes.

Applications

- 350Mw Surface mount zener diode

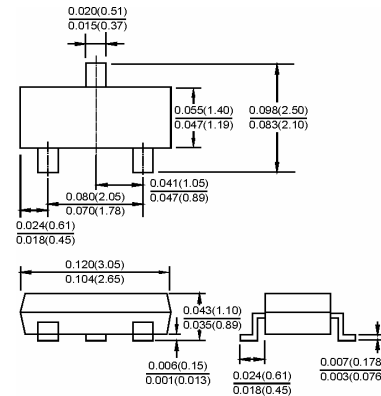

Dimensions in inches and (millimeters)

Ordering Information

Type No.	Marking	Package Code
BZX84C2V4-BZX84C51	See Table on page2	SOT-23

MAXIMUM RATING @ Ta=25°C unless otherwise specified

Characteristic	Symbol	Value	Unit
Forward Voltage@I _F =10mA	V _F	0.9	V
Power Dissipation	P _d	350	mW
Thermal Resistance, Junction to Ambient Air	R _{θJA}	357	°C/W
Operating and Storage Temperature Range	T _J , T _{stg}	-65 to+150	°C

- Notes: 1. Valid provided that device terminals are kept at ambient temperature.
 2. Tested with pulses, 300µs pulse width, period = 5ms.
 3. f = 1KHz.

ELECTRICAL CHARACTERISTICS @ Ta=25°C unless otherwise specified

Type Number	Marking Code	Zener Voltage Range				Maximum Zener Impedance			Maximum Reverse Current		Typical Temperature Coefficient @I _{ZT} mV/°C	
		V _Z @I _{ZT}			I _{ZT}	Z _{ZT} @I _{ZT}	Z _{ZK} @I _{ZK}		I _R	V _R	Min	Max
		Nom(V)	Min(V)	Max(V)	(mA)	(Ω)	(Ω)	(mA)	(μA)	(V)		
BZX84C2V4	Z11	2.4	2.2	2.6	5.0	100	600	1.0	50	1.0	-3.5	0
BZX84C2V7	Z12	2.7	2.5	2.9	5.0	100	600	1.0	20	1.0	-3.5	0
BZX84C3V0	Z13	3.0	2.8	3.2	5.0	95	600	1.0	10	1.0	-3.5	0
BZX84C3V3	Z14	3.3	3.1	3.5	5.0	95	600	1.0	5.0	1.0	-3.5	0
BZX84C3V6	Z15	3.6	3.4	3.8	5.0	90	600	1.0	5.0	1.0	-3.5	0
BZX84C3V9	Z16	3.9	3.7	4.1	5.0	90	600	1.0	3.0	1.0	-3.5	0
BZX84C4V3	Z17	4.3	4.0	4.6	5.0	90	600	1.0	3.0	1.0	-3.5	0
BZX84C4V7	Z1	4.7	4.4	5.0	5.0	80	500	1.0	3.0	2.0	-3.5	0.2
BZX84C5V1	Z2	5.1	4.8	5.4	5.0	60	480	1.0	2.0	2.0	-2.7	1.2
BZX84C5V6	Z3	5.6	5.2	6.0	5.0	40	400	1.0	1.0	2.0	-2.0	2.5
BZX84C6V2	Z4	6.2	5.8	6.6	5.0	10	150	1.0	3.0	4.0	0.4	3.7
BZX84C6V8	Z5	6.8	6.4	7.2	5.0	15	80	1.0	2.0	4.0	1.2	4.5
BZX84C7V5	Z6	7.5	7.0	7.9	5.0	15	80	1.0	1.0	5.0	2.5	5.3
BZX84C8V2	Z7	8.2	7.7	8.7	5.0	15	80	1.0	0.7	5.0	3.2	6.2
BZX84C9V1	Z8	9.1	8.5	9.6	5.0	15	100	1.0	0.5	6.0	3.8	7.0
BZX84C10	Z9	10	9.4	10.6	5.0	20	150	1.0	0.2	7.0	4.5	8.0
BZX84C11	Y1	11	10.4	11.6	5.0	20	150	1.0	0.1	8.0	5.4	9.0

Type Number	Marking Code	Zener Voltage Range				Maximum Zener Impedance			Maximum Reverse Current		Typical Temperature Coefficient @I _{ZT} mV/°C	
		V _Z @I _{ZT}			I _{ZT}	Z _{ZT} @I _{ZT}	Z _{ZK} @I _{ZK}		I _R	V _R	Min	Max
		Nom(V)	Min(V)	Max(V)	(mA)	(Ω)	(Ω)	(mA)	(μA)	(V)		
BZX84C12	Y2	12	11.4	12.7	5.0	25	150	1.0	0.1	8.0	6.0	10.0
BZX84C13	Y3	13	12.4	14.1	5.0	30	170	1.0	0.1	8.0	7.0	11.0
BZX84C15	Y4	15	13.8	15.6	5.0	30	200	1.0	0.1	10.5	9.2	13.0
BZX84C16	Y5	16	15.3	17.1	5.0	40	200	1.0	0.1	11.2	10.4	14.0
BZX84C18	Y6	18	16.8	19.1	5.0	45	225	1.0	0.1	12.6	12.4	16.0
BZX84C20	Y7	20	18.8	21.2	5.0	55	225	1.0	0.1	14.0	14.4	18.0
BZX84C22	Y8	22	20.8	23.3	5.0	55	250	1.0	0.1	15.4	16.4	20.0
BZX84C24	Y9	24	22.8	25.6	5.0	70	250	1.0	0.1	16.8	18.4	22.0
BZX84C27	Y10	27	25.1	28.9	2.0	80	300	0.5	0.1	18.9	21.4	25.3
BZX84C30	Y11	30	28.0	32.0	2.0	80	300	0.5	0.1	21.0	24.4	29.4
BZX84C33	Y12	33	31.0	35.0	2.0	80	325	0.5	0.1	23.1	27.4	33.4
BZX84C36	Y13	36	34.0	38.0	2.0	90	350	0.5	0.1	25.2	30.4	37.4
BZX84C39	Y14	39	37.0	41.0	2.0	130	350	0.5	0.1	27.3	33.4	41.2
BZX84C43	Y15	43	40.0	46.0	2.0	150	375	0.5	0.1	30.1	10.0	12.0
BZX84C47	Y16	47	44.0	50.0	2.0	170	375	0.5	0.1	32.9	10.0	12.0
BZX84C51	Y17	51	48.0	54.0	2.0	180	400	0.5	0.1	35.7	10.0	12.0

TYPICAL CHARACTERISTICS @ Ta=25°C unless otherwise specified

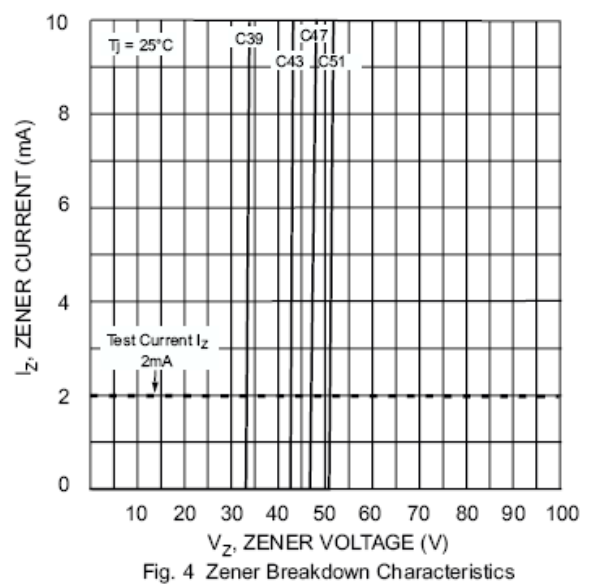
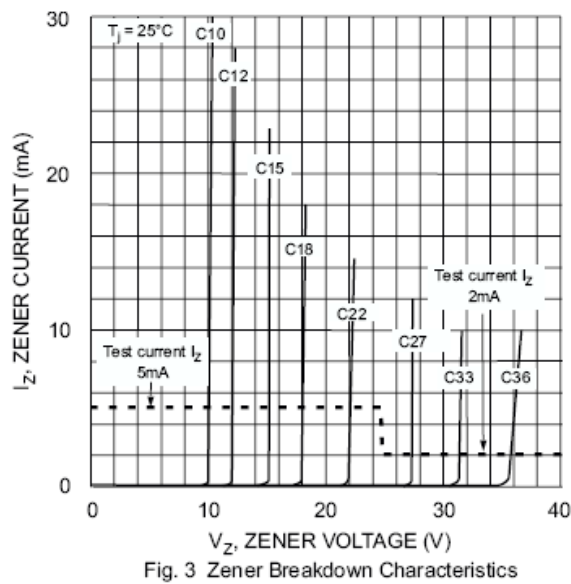
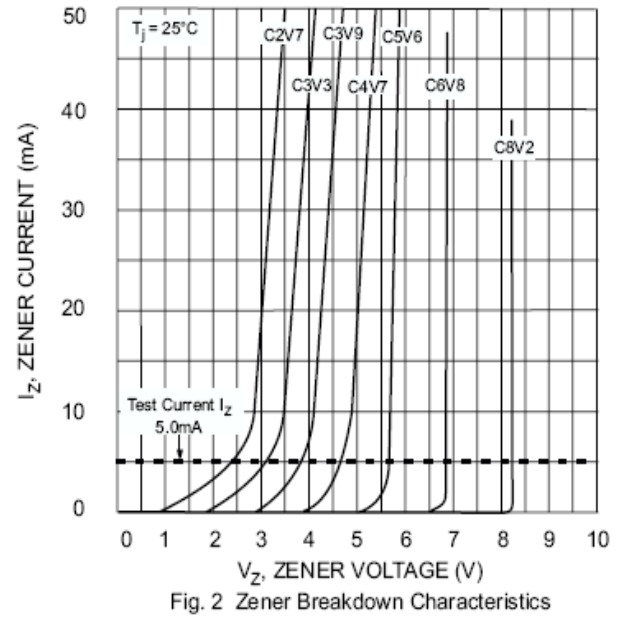
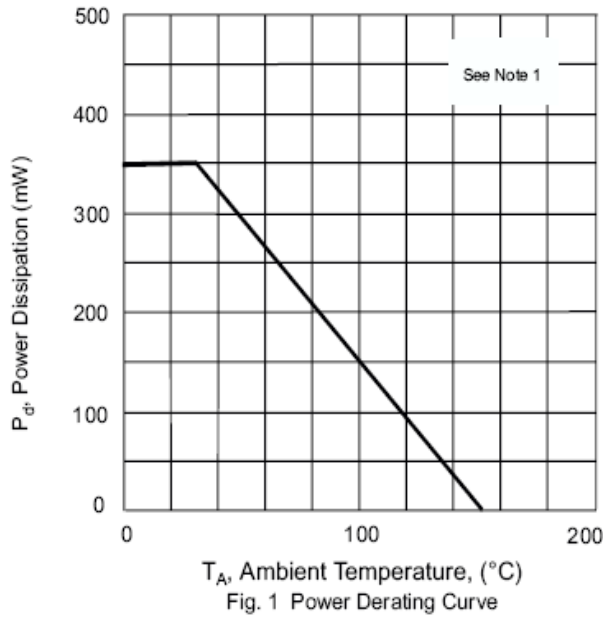

PACKAGE	SPQ/PCS	CARTON SPQ/PCS	CARTON SIZE/CM	CARTON GW/KG	CARTON NW/KG
SOT-23	3000/REEL	90000	40X20X22	5.00	4.00

MOUNTING PAD LAYOUT

SOT-23

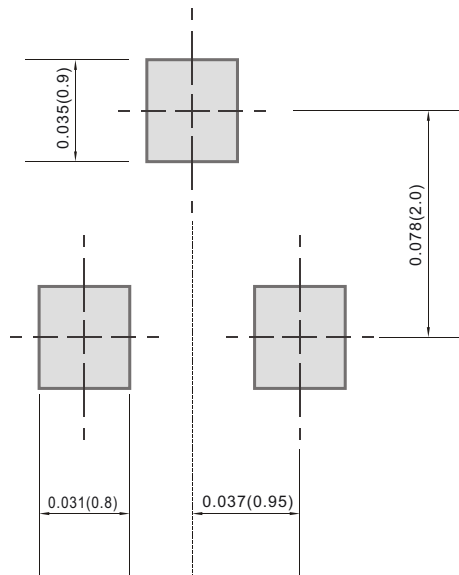

Unit: inch (mm)

X-ON Electronics

Largest Supplier of Electrical and Electronic Components

Click to view similar products for [Zener Diodes](#) category:

Click to view products by [LGE](#) manufacturer:

Other Similar products are found below :

[RKZ13B2KG#P1](#) [DL5234B](#) [EDZTE6113B](#) [1N4682](#) [1N4691](#) [1N4693](#) [1N4732A](#) [1N4736A](#) [1N4750A](#) [1N4759ARL](#) [1N5241B](#) [1N5365B](#)
[1N5369B](#) [1N747A](#) [1N959B](#) [1N964B](#) [1N966B](#) [1N968B](#) [1N972B](#) [NTE5121A](#) [NTE5147A](#) [NTE5152A](#) [NTE5155A](#) [NTE5164A](#)
[JANS1N4974US](#) [1N4692](#) [1N4700](#) [1N4702](#) [1N4704](#) [1N4711](#) [1N4714](#) [1N4737A](#) [1N4745ARL](#) [1N4752A](#) [1N4752ARL](#) [1N4760ARL](#)
[1N5221B](#) [1N5236B](#) [1N5241BTR](#) [1N5242BTR](#) [1N5350B](#) [1N5352B](#) [1N961BRR1](#) [1N964BRL](#) [RKZ5.1BKU#P6](#) [3SMAJ5946B-TP](#)
[3SMAJ5950B-TP](#) [3SMBJ5925B-TP](#) [441774C](#) [BZX84C3V9](#)