

MBR3035CT-MBR30200CT

30.0AMP. Schottky Barrier Rectifiers



TO-220AB



Features

- ✦ Plastic material used carries Underwriters Laboratory Classifications 94V-0
- ✦ Metal silicon junction, majority carrier conduction
- ✦ Low power loss, high efficiency
- ✦ High current capability, low forward voltage drop
- ✦ High surge capability
- ✦ For use in low voltage, high frequency inverters, free wheeling, and polarity protection applications
- ✦ Guardring for overvoltage protection
- ✦ High temperature soldering guaranteed: 260°C/10 seconds, 0.25" (6.35mm) from case

Mechanical Data

- ✦ Cases: JEDEC TO-220AB molded plastic
- ✦ Polarity: As marked
- ✦ Mounting position: Any
- ✦ Mounting torque: 5 in. - lbs. max
- ✦ Weight: 2.24 grams

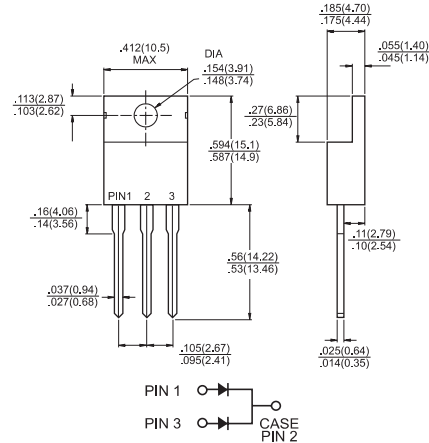

Dimensions in inches and (millimeters)

Maximum Ratings and Electrical Characteristics

Rating at 25 °C ambient temperature unless otherwise specified.

Single phase, half wave, 60 Hz, resistive or inductive load.

For capacitive load, derate current by 20%

Type Number	Symbol	MBR 3035 CT	MBR 3045 CT	MBR 3050 CT	MBR 3060 CT	MBR 3090 CT	MBR 30100 CT	MBR 30150 CT	MBR 30200 CT	Units
Maximum Recurrent Peak Reverse Voltage	V_{RRM}	35	45	50	60	90	100	150	200	V
Maximum RMS Voltage	V_{RMS}	24	31	35	42	63	70	105	140	V
Maximum DC Blocking Voltage	V_{DC}	35	45	50	60	90	100	150	200	V
Maximum Average Forward Rectified Current at $T_c=130^\circ\text{C}$	$I_{(AV)}$	30								A
Peak Repetitive Forward Current (Rated V_R , Square Wave, 20KHz) at $T_c=130^\circ\text{C}$	I_{FRM}	30								A
Peak Forward Surge Current, 8.3 ms Single Half Sine-wave Superimposed on Rated Load (JEDEC method)	I_{FSM}	200								A
Peak Repetitive Reverse Surge Current (Note 1)	I_{RRM}	1.0			0.5					A
Maximum Instantaneous Forward Voltage at (Note 2) $I_F=15\text{A}$, $T_c=25^\circ\text{C}$	V_F	0.7	0.8		0.85		0.92			V
Maximum Instantaneous Reverse Current @ $T_c=25^\circ\text{C}$ at Rated DC Blocking Voltage Per Leg @ $T_c=125^\circ\text{C}$ (Note 2)	I_R	0.05								mA
Voltage Rate of Change, (Rated V_R)	dV/dt	1,000								V/uS
Typical Junction Capacitance	C_j	600	460		320					pF
Maximum Thermal Resistance Per Leg (Note 3)	$R_{\theta JC}$	1.4								$^\circ\text{C}/\text{W}$
Operating Junction Temperature Range	T_J	-65 to +150								$^\circ\text{C}$
Storage Temperature Range	T_{STG}	-65 to +175								$^\circ\text{C}$

- Notes:
1. 2.0us Pulse Width, $f=1.0\text{ KHz}$
 2. Pulse Test: 300us Pulse Width, 1% Duty Cycle
 3. Thermal Resistance from Junction to Case Per Leg, with Heatsink size (4"x6"x0.25") Al-Plate

MBR3035CT-MBR30200CT

30.0AMP. Schottky Barrier Rectifiers



RATINGS AND CHARACTERISTIC CURVES

FIG.1- FORWARD CURRENT DERATING CURVE

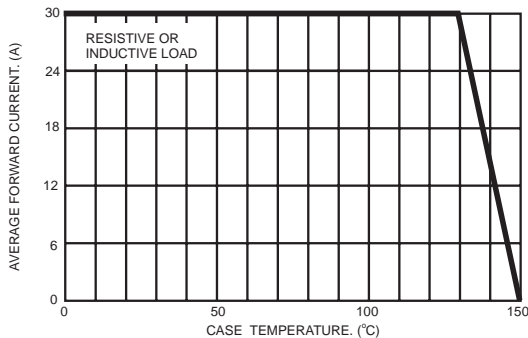

FIG.2- MAXIMUM NON-REPETITIVE FORWARD SURGE CURRENT PER LEG

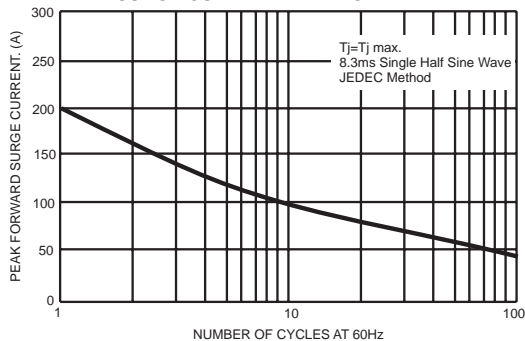

FIG.3- TYPICAL INSTANTANEOUS FORWARD CHARACTERISTICS PER LEG

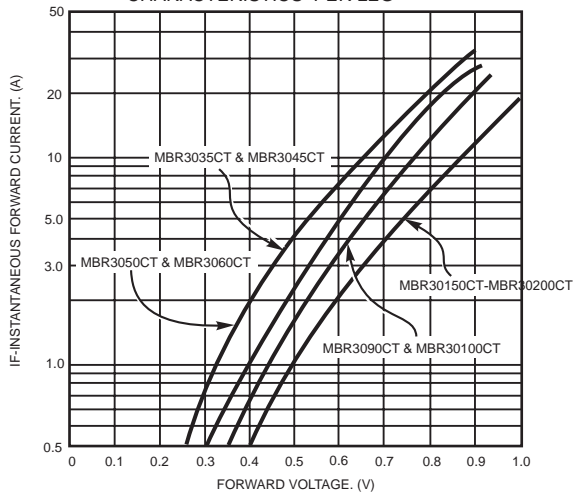

FIG.4- TYPICAL REVERSE CHARACTERISTICS PER LEG

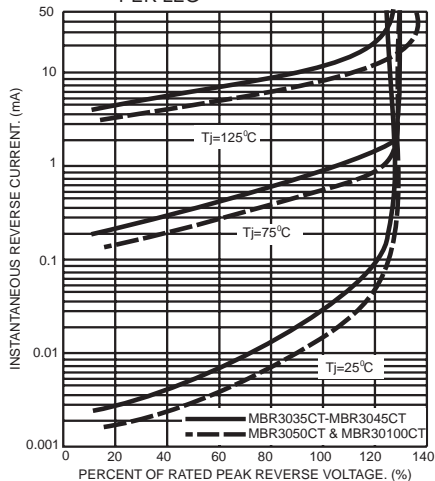

FIG.5- TYPICAL JUNCTION CAPACITANCE PER LEG

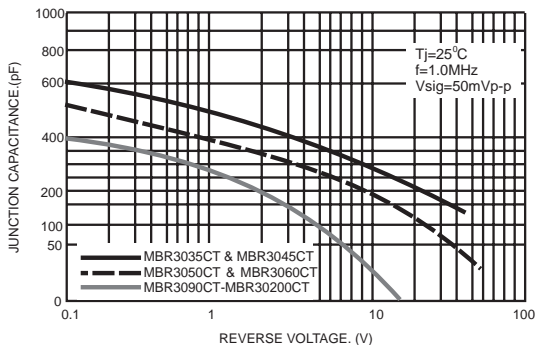
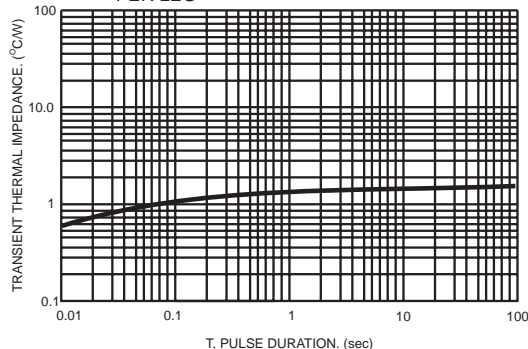

FIG.6- TYPICAL TRANSIENT THERMAL IMPEDANCE PER LEG



X-ON Electronics

Largest Supplier of Electrical and Electronic Components

Click to view similar products for [Schottky Diodes & Rectifiers](#) category:

Click to view products by [LGE](#) manufacturer:

Other Similar products are found below :

[MA4E2039](#) [MMBD301M3T5G](#) [RB160M-50TR](#) [D83C](#) [BAS16E6433HTMA1](#) [BAS 3010S-02LRH E6327](#) [BAT 54-02LRH E6327](#)
[NRVBAF360T3G](#) [NSR05F40QNXT5G](#) [NTE555](#) [JANS1N6640](#) [SS3003CH-TL-E](#) [GA01SHT18](#) [CRS10I30A\(TE85L,QM](#) [MBRA140TRPBF](#)
[MBRB30H30CT-1G](#) [BAT 15-04R E6152](#) [JANTX1N5712-1](#) [DMJ3940-000](#) [SB007-03C-TB-E](#) [NRVBB20100CTT4G](#) [NRVBM120LT1G](#)
[NTSB30U100CT-1G](#) [CRG04\(T5L,TEMQ\)](#) [ACDBA1100LR-HF](#) [ACDBA1200-HF](#) [ACDBA240-HF](#) [ACDBA3100-HF](#) [CDBQC0530L-HF](#)
[ACDBA260LR-HF](#) [ACDBA1100-HF](#) [10BQ015-M3/5BT](#) [NRVBM120ET1G](#) [VSSB410S-M3/5BT](#) [1N5819T-G](#) [PDS1040Q-13](#) [B160BQ-13-F](#)
[SDM05U20CSP-7](#) [BAS 70-07 E6433](#) [B140S1F-7](#) [HSM560Je3/TR13](#) [DDB2265-000](#) [ZHCS506QTA](#) [HSM190Je3/TR13](#) [B330AF-13](#)
[ACDBUC0230-HF](#) [SDM1U100S1F-7](#) [MBR10200CTF-G1](#) [CDLL5712](#) [DMF2822-000](#)