

## SOT-23

### Features

- ✧ Fast switching speed.
- ✧ High conductance.
- ✧ For general purpose switching applications.
- ✧ Surface mount package ideally suited for automatic insertion.

### Applications

- ✧ Small signal switching

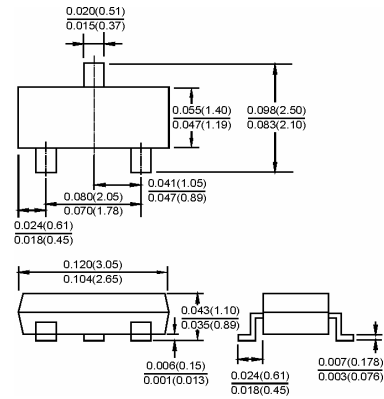

Dimensions in inches and (millimeters)



MMBD4148A

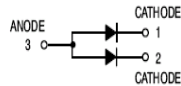

MMBD4148CA

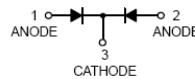

MMBD4148CC

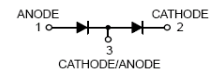

MMBD4148SE

### Ordering Information

| Type No.   | Marking | Package Code |
|------------|---------|--------------|
| MMBD4148A  | 5H      | SOT-23       |
| MMBD4148CA | D6      | SOT-23       |
| MMBD4148CC | D5      | SOT-23       |
| MMBD4148SE | D4      | SOT-23       |

### MAXIMUM RATING @ Ta=25°C unless otherwise specified

| Parameter  | Symbol          | Limits     | Unit |
|--|-----------------|------------|------|
| DC Reverse Voltage   | $V_R$           | 100        | V    |
| Forward Continuous Current(Max.)                           | $I_{FM}$        | 600        | mA   |
| Average rectified Current                                  | $I_{F(AV)}$     | 200        | mA   |
| Recurrent peak forward current                             | $I_{FRM}$       | 700        | mA   |
| Non-repetitive peak forward surge current (1.0s)<br>(1.0m) | $I_{FSM}$       | 1.0<br>2.0 | A    |
| Power Dissipation  | $P_d$           | 350        | mW   |
| Thermal resistance, Junction to ambient                    | $R_{\theta JA}$ | 357        | °C/W |
| Operating junction temperature                             | $T_J$           | 150        | °C   |
| Storage temperature range                                  | $T_{STG}$       | -55-150    | °C   |

## ELECTRICAL CHARACTERISTICS @ Ta=25°C unless otherwise specified

| Parameter                 | Symbol       | Min. | Typ. | Max. | Unit    | Conditions  |
|---------------------------|--------------|------|------|------|---------|---|
| Reverse Breakdown Voltage | $V_{(BR)R1}$ | 100  |      |      | V       | $I_R=100\mu A$  |
|                           | $V_{(BR)R2}$ | 75   |      |      | V       | $I_R=5\mu A$  |
| Forward voltage           | $V_F$        |      |      | 1    | V       | $I_F=10mA$  |
| Reverse current           | $I_{R1}$     |      |      | 25   | nA      | $V_R=20V$   |
|                           | $I_{R2}$     |      |      | 5    | $\mu A$ | $V_R=75V$   |
| Diode Capacitance         | $C_D$        |      |      | 4    | pF      | $V_R=0V, f=1MHz$  |
| Reverse Recovery Time     | $t_{rr}$     |      |      | 4    | ns      | $I_F=10mA, V_R=6V$<br>$I_{rr}=0.1 * I_R, R_L=100\Omega$ |

## TYPICAL CHARACTERISTICS @ Ta=25°C unless otherwise specified

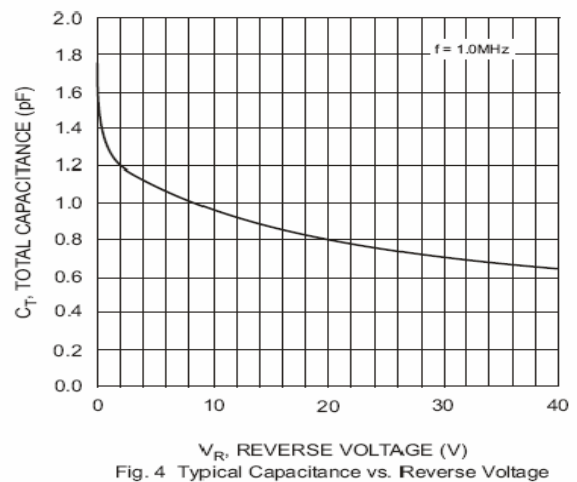
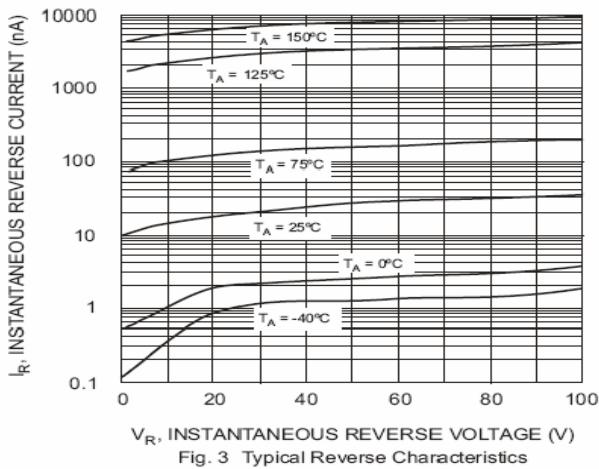
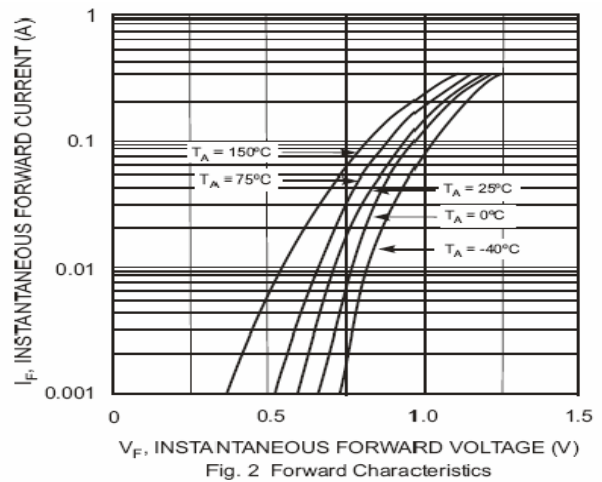
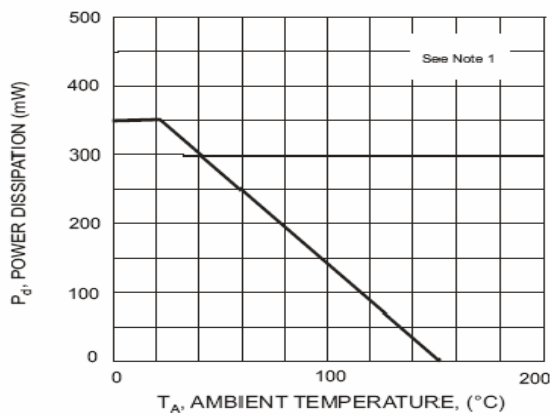

| PACKAGE | SPQ/PCS   | CARTON SPQ/PCS | CARTON SIZE/CM | CARTON GW/KG | CARTON NW/KG |
|---------|-----------|----------------|----------------|--------------|--------------|
| SOT-23  | 3000/REEL | 90000          | 40X20X22       | 5.00         | 4.00         |

## X-ON Electronics

Largest Supplier of Electrical and Electronic Components

*Click to view similar products for [Diodes - General Purpose, Power, Switching category](#):*

*Click to view products by [LGE manufacturer](#):*

Other Similar products are found below :

[MMBD3004S-13-F](#) [RD0306T-H](#) [BAV17-TR](#) [BAV19-TR](#) [1N3611](#) [NTE156A](#) [NTE574](#) [NTE6244](#) [1SS181-TP](#) [1SS193,LF](#) [1SS400CST2RA](#)  
[SDAA13](#) [SHN2D02FUTW1T1G](#) [LS4151GS08](#) [1N4449](#) [1N456A](#) [1N4934-E3/73](#) [1N914B](#) [1N914BTR](#) [1SS226-TP](#) [RFUH20TB3S](#)  
[D291S45T](#) [BAV300-TR](#) [BAW56DWQ-7-F](#) [BAW75-TAP](#) [MM230L-CAA](#) [IDW40E65D1](#) [JAN1N3600](#) [LL4151-GS18](#) [053684A](#)  
[SMMSD4148T3G](#) [707803H](#) [NSVDAN222T1G](#) [CDSZC01100-HF](#) [LL4150-M-08](#) [1N4454-TR](#) [BAV199E6433HTMA1](#) [BAS28-7](#)  
[BAW56HDW-13](#) [BAS28 TR](#) [VS-HFA04SD60STR-M3](#) [NSVM1MA152WKT1G](#) [RGP30D-E3/73](#) [BAV99TQ-13-F](#) [BAS21DWA-7](#)  
[BAV99HDW-13](#) [NTE6250](#) [NTE582-4](#) [NTE582-6](#) [MMDB30-E28X](#)